



Armarinho e Lembrancinha

ÍNDICE INTERATIVO

ARAMES DE CHENILLE	06
OLHO MÓVEL E CARTELA	08
BASTIDORES	09
TELA PLÁSTICA & MANTA MAGNÉTICA	11
AGULHA DE SACARINA	13
AGULHA DE CROCHÊ	14
AGULHAS DIVERSAS P/ COSTURA	16
ALFINETES	19
PASSADORES	23
BOBINAS	24
CORTE E COSTURA	26
CANETAS E GIZ PARA COSTURA	32
FITAS MÉTRICAS	33
COLCHETES	34
TESOURAS	37
RÉGUAS	40
PRENEDORES P/ PATCHWORK	44
KITS DE TEAR	45
BASTÃO DE COLA PARA ARTESANATO	46
FIOS E CORDÕES	47
PENAS	52
FITA DE CETIM C/ ROCOCÓ	56
CORDÃO ROLITE	57
FIOS TIPO CAMURÇA	59
FIOS DE LANTEJOULA	63
ROLOS DE LÃ	69
FIOS DE MALHA 1KG	71
FIOS DE POMPOM	72
POMPONS DIVERSOS	75
PRENEDORES DIVERSOS	88
ADESIVOS PARA PRENEDORES	90
BICOS DE PATO	91
TIC TAC ENCAPADO	92
PRESILHAS ENCAPADAS	93
TIARAS FORRADAS	97
TIARAS DIVERSAS	99
ABRAÇADEIRAS	102
CHAVEIROS, ARGOLAS E FECHOS	103

ÍNDICE INTERATIVO

SIANINHAS	107
CORDÃO SÃO FRANCISCO	110
PINGENTES	113
GLITTERS DIVERSOS	120
MINI ROSA DE E.V.A	125
MINI ROSA DE PAPEL	126
ARTESANATO	127
RENDAS	131
FITA DE FLOR	135
FITA DE VOAL	138
FITAS DOURADAS	150
FITAS METÁLICAS	152
FITAS DE RENDA	155
PASSAMANARIA	157
GUIPIR / GRIPIR	168
BORDADO INGLÊS	177
BORDADO PASSA FITA	182
BORDADO INGLÊS COM PASSA FITA	183
FRANJAS DE PENA E BOA DE PLUMA	184
FRANJAS COLORIDAS	188
FRANJAS METÁLICAS	198
FRANJAS LANTEJOULA	200
APLICAÇÃO DE PAETÊ	203
APLICAÇÃO DE TRICÔ	207
APLICAÇÃO DE LAÇO	208
APLICAÇÃO DE FLOR	209
PALAS	212
MINI ROCOCÓ	213
IMÃ	215
PEROLAS	216
MIÇANGAS / CANUTILHO / VIDRILHO	220
CONTAS P/ ARTESANATO	225
FIO DE SILICONE / COBRE	233
CAIXA PLÁSTICA ORGANIZADORA	235
SAQUINHO PLÁSTICO	239
MINI POTE DE VIDRO	242

ÍNDICE INTERATIVO

E.V.A C/ GLITTER	243
FITAS ADESIVAS DUPLA FACE	245
FAIXAS REFLETIVAS	246
SAQUINHO DE VOAL & PORTA RECADOS	248
FITAS DECORATIVAS	249
AMARRADOR DE CABELO	258



Algumas informações que vão te ajudar!

Recebeu a sua mercadoria?

Lembre-se de conferir os produtos no ato da entrega! Em qualquer sinal de avaria, faça uma ressalva no verso do conhecimento de transporte. Nos comunique imediatamente qualquer defeito ou problema com os nossos produtos no ocorrencias@bazarimportadora.com.br

Os nossos boletos são anexados a Nota Fiscal!

Desconfie de boletos não solicitados enviados por e-mail fora do horário comercial. Pode ser **FRAUDE!**
Nós não nos responsabilizamos por pagamentos indevidos.
Entre em contato com o financeiro@bazarimportadora.com.br

Tabela Interativa!

Clique no link azul para ser redirecionado ao  Youtube e conferir um vídeo do produto!

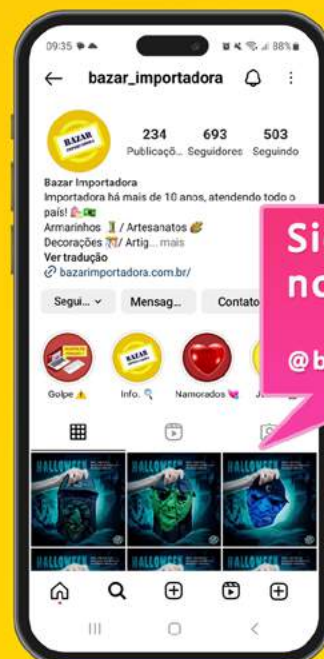
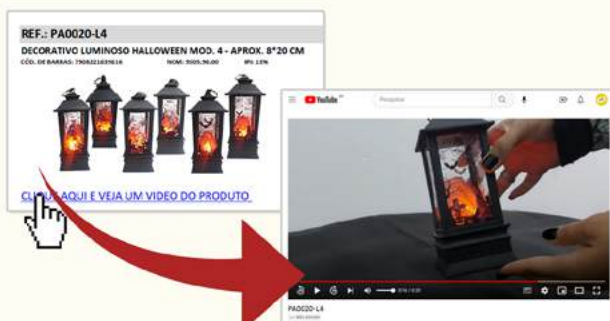

Siga nosso perfil no **INSTAGRAM**

@bazar_importadora



ARAME DE CHENILLE - ARAME ENCAPADO

PACOTE COM 100 UNID DA MESMA COR

CX MASTER 100 PCT

FRAÇÃO 5 PACOTES

APROX. 30 CM

R\$ 5,05

PREÇO PACOTE

R\$ 5,55

PREÇO PACOTE



REF.: LB0051-C15

ARAME ENCAPADO COR.15
CÓDIGO DE BARRA: 7908221650956
NCM: 95059000 IPI: 13%



REF.: LB0051-C32

ARAME ENCAPADO COR.32
CÓDIGO DE BARRA: 7908221671906
NCM: 95059000 IPI: 13%



REF.: LB0051-C33

DECORATIVO TIPO ARAME ENCAPADO COR.15
CÓDIGO DE BARRA: 7908221671913
NCM: 95059000 IPI: 13%



REF.: LB0051-C11

DECORATIVO TIPO ARAME ENCAPADO COR.11
CÓDIGO DE BARRA: 7908221650918
NCM: 95059000 IPI: 13%



REF.: LB0051-C6

DECORATIVO TIPO ARAME ENCAPADO COR.6
CÓDIGO DE BARRA: 7908221650864
NCM: 95059000 IPI: 13%



REF.: ESGOTADO

DECORATIVO TIPO ARAME ENCAPADO COR.1
CÓDIGO DE BARRA: 7908221650819
NCM: 95059000 IPI: 13%



REF.: LB0051-C5

DECORATIVO TIPO ARAME ENCAPADO COR.5
CÓDIGO DE BARRA: 7908221650857
NCM: 95059000 IPI: 13%



REF.: LB0051-C4

DECORATIVO TIPO ARAME ENCAPADO COR.4
CÓDIGO DE BARRA: 7908221650840
NCM: 95059000 IPI: 13%



REF.: LB0051-C3

DECORATIVO TIPO ARAME ENCAPADO COR.3
CÓDIGO DE BARRA: 7908221650833
NCM: 95059000 IPI: 13%



REF.: LB0051-C2

DECORATIVO TIPO ARAME ENCAPADO COR.2
CÓDIGO DE BARRA: 7908221650826
NCM: 95059000 IPI: 13%



REF.: ESGOTADO

DECORATIVO TIPO ARAME ENCAPADO COR.10
CÓDIGO DE BARRA: 7908221650901
NCM: 95059000 IPI: 13%

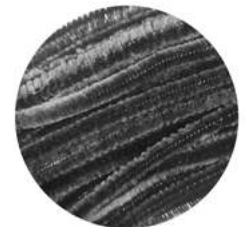

REF.: LB0051-C14

DECORATIVO TIPO ARAME ENCAPADO COR.14
CÓDIGO DE BARRA: 7908221650949
NCM: 95059000 IPI: 13%



ESGOTADO

DECORATIVO TIPO ARAME ENCAPADO COR.7
CÓDIGO DE BARRA: 7908221650871
NCM: 95059000 IPI: 13%



ESGOTADO

DECORATIVO TIPO ARAME ENCAPADO COR.8
CÓDIGO DE BARRA: 7908221650888
NCM: 95059000 IPI: 13%



REF.: LB0051-C9

DECORATIVO TIPO ARAME ENCAPADO COR.9
CÓDIGO DE BARRA: 7908221650895
NCM: 95059000 IPI: 13%

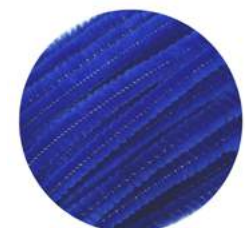

REF.: LB0051-C12

DECORATIVO TIPO ARAME ENCAPADO COR.12
CÓDIGO DE BARRA: 7908221650925
NCM: 95059000 IPI: 13%

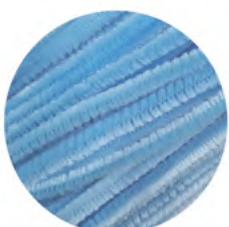

REF.: LB0051-C13

DECORATIVO TIPO ARAME ENCAPADO COR.13
CÓDIGO DE BARRA: 7908221650932
NCM: 95059000 IPI: 13%



REF.: LB0051-C34

DECORATIVO TIPO ARAME ENCAPADO COR.11
CÓDIGO DE BARRA: 7908221671920
NCM: 95059000 IPI: 13%



**BAZAR
IMPORTADORA**

ARAME DE CHENILLE - ARAME ENCAPADO

CANDY COLOR

APROX. 30 CM

PACOTE COM 100 UNID DA MESMA COR

CX MASTER 100 PCT

FRAÇÃO 5 PACOTES

R\$ 5,05

PREÇO PACOTE

R\$ 5,55

PREÇO PACOTE



REF.: LB0051-C25

DECORATIVO TIPO ARAME ENCAPADO COR.25

CÓDIGO DE BARRA: 7908221671838

NCM: 95059000 IPI: 13%



REF.: LB0051-C26

DECORATIVO TIPO ARAME ENCAPADO COR.26

CÓDIGO DE BARRA: 7908221671845

NCM: 95059000 IPI: 13%



REF.: LB0051-C23

DECORATIVO TIPO ARAME ENCAPADO COR.23

CÓDIGO DE BARRA: 7908221671814

NCM: 95059000 IPI: 13%



REF.: LB0051-C24

DECORATIVO TIPO ARAME ENCAPADO COR.24

CÓDIGO DE BARRA: 7908221671821

NCM: 95059000 IPI: 13%



REF.: LB0051-C27

DECORATIVO TIPO ARAME ENCAPADO COR.27

CÓDIGO DE BARRA: 7908221671852

NCM: 95059000 IPI: 13%



REF.: LB0051-C29

DECORATIVO TIPO ARAME ENCAPADO COR.29

CÓDIGO DE BARRA: 7908221671876

NCM: 95059000 IPI: 13%



PACOTE COM 100 UNID DA MESMA COR

CX MASTER 100 PCT

FRAÇÃO 5 PACOTES

R\$ 6,50

PREÇO PACOTE

R\$ 7,15

PREÇO PACOTE

METALIZADO

APROX. 30 CM



REF.: LB0051-C17

DECORATIVO TIPO ARAME ENCAPADO COR.17

CÓDIGO DE BARRA: 7908221650970

NCM: 95059000 IPI: 13%



REF.: LB0051-C16

DECORATIVO TIPO ARAME ENCAPADO COR.16

CÓDIGO DE BARRA: 7908221650963

NCM: 95059000 IPI: 13%

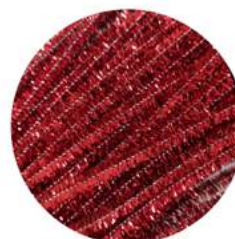

REF.: LB0051-C18

DECORATIVO TIPO ARAME ENCAPADO COR.18

CÓDIGO DE BARRA: 7908221650987

NCM: 95059000 IPI: 13%



REF.: LB0051-C21

DECORATIVO TIPO ARAME ENCAPADO COR.21

CÓDIGO DE BARRA: 7908221651014

NCM: 95059000 IPI: 13%



REF.: LB0051-C20

DECORATIVO TIPO ARAME ENCAPADO COR.20

CÓDIGO DE BARRA: 7908221651007

NCM: 95059000 IPI: 13%

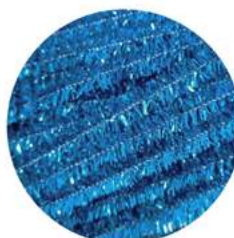

REF.: LB0051-C22

DECORATIVO TIPO ARAME ENCAPADO COR.22

CÓDIGO DE BARRA: 7908221651021

NCM: 95059000 IPI: 13%



REF.: LB0051-C19

DECORATIVO TIPO ARAME ENCAPADO COR.19

CÓDIGO DE BARRA: 7908221650994

NCM: 95059000 IPI: 13%



OLHO MÓVEL



OLHO MÓVEL - FARDO C/ 10 PACOTES COM 100 UNID

03 mm	REF: AR2222-03 OLHO MÓVEL 3MM - 10x100 CÓD.BARRA: 7908221614743 NCM: 39269090 IPI: 9,75%	FRAÇÃO FARDO R\$ 13,50 PREÇO POR FARDO	10 mm	REF: AR2222-10 OLHO MÓVEL 10MM - 10x100 CÓD. DE BARRA: 7908221614774 NCM: 39269090 IPI: 9,75%	ESGOTADO
04 mm	REF: AR2222-04 OLHO MÓVEL 4MM - 10x100 CÓD. DE BARRA: 7908221614750 NCM: 39269090 IPI: 9,75%	FRAÇÃO FARDO R\$ 13,90 PREÇO POR FARDO	12 mm	REF: AR2222-12 OLHO MÓVEL 12MM - 10x100 CÓD. DE BARRA: 7908221618604 NCM: 39269090 IPI: 9,75%	ESGOTADO
05 mm	REF: AR2222-05 OLHO MÓVEL 5MM - 10x100 CÓD. DE BARRA: 7908221614767 NCM: 39269090 IPI: 9,75%	FRAÇÃO FARDO R\$ 14,50 PREÇO POR FARDO	15 mm	REF: AR2222-15 OLHO MÓVEL 15MM - 10x100 CÓD. DE BARRA: 7908221614781 NCM: 39269090 IPI: 9,75%	ESGOTADO
06 mm	REF: AR2222-06 OLHO MÓVEL 6MM - 10x100 CÓD. DE BARRA: 7908221618574 NCM: 39269090 IPI: 9,75%	FRAÇÃO FARDO R\$ 14,50 PREÇO POR FARDO	18 mm	REF: AR2222-18 OLHO MÓVEL 18MM - 10x100 CÓD. DE BARRA: 7908221618611 NCM: 39269090 IPI: 9,75%	FRAÇÃO FARDO R\$ 39,90 PREÇO POR FARDO
07 mm	REF: AR2222-07 OLHO MÓVEL 7MM - 10x100 CÓD. DE BARRA: 7908221618581 NCM: 39269090 IPI: 9,75%	FRAÇÃO FARDO R\$ 14,50 PREÇO POR FARDO	20 mm	REF: AR2222-20 OLHO MÓVEL 20MM - 10x100 CÓD DE BARRA: 7908221614798 NCM: 39269090 IPI: 9,75%	FRAÇÃO FARDO R\$ 69,90 PREÇO POR FARDO
08 mm	REF: AR2222-08 OLHO MÓVEL 8MM - 10x100 CÓD. DE BARRA: 7908221618598 NCM: 39269090 IPI: 9,75%	FRAÇÃO FARDO R\$ 20,90 PREÇO POR FARDO			

OLHO MÓVEL COLORIDO - CARTELA ADESIVA

08 mm	REF: AR2222-ADM8 CARTELA ADESIVA 8 MM - 1X63 CÓD. DE BARRA: 7908221623783 NCM: 3926.90.90 IPI: 9,75%	FRAÇÃO 12 CARTELAS MESMA COR R\$ 3,30 PREÇO CARTELA
10 mm	REF: AR2222-ADM10 CARTELA ADESIVA 10 MM - 1X48 CÓDIGO DE BARRA: 7908221624261 NCM: 3926.90.90 IPI: 9,75%	FRAÇÃO 12 CARTELAS MESMA COR R\$ 3,30 PREÇO CARTELA
12 mm	REF: AR2222-ADM12 CARTELA ADESIVA 12 MM - 1X40 CÓDIGO DE BARRA: 7908221623806 NCM: 3926.90.90 IPI: 9,75%	FRAÇÃO 12 CARTELAS MESMA COR R\$ 3,30 PREÇO CARTELA



OLHO MÓVEL PRETO - CARTELA ADESIVA

10 mm	REF: AR2222-AD10 CARTELA ADESIVA 10 MM - 1X60 CÓDIGO DE BARRA: 7908221623769 NCM: 3926.90.90 IPI: 9,75%	FRAÇÃO 12 CARTELAS ESGOTADO
12 mm	REF: AR2222-AD12 CARTELA ADESIVA 12 MM - 1X50 CÓDIGO DE BARRA: 7908221623776 NCM: 3926.90.90 IPI: 9,75%	FRAÇÃO 12 CARTELAS ESGOTADO



BASTIDOR

BASTIDOR DE MADEIRA C/ TARRAXA

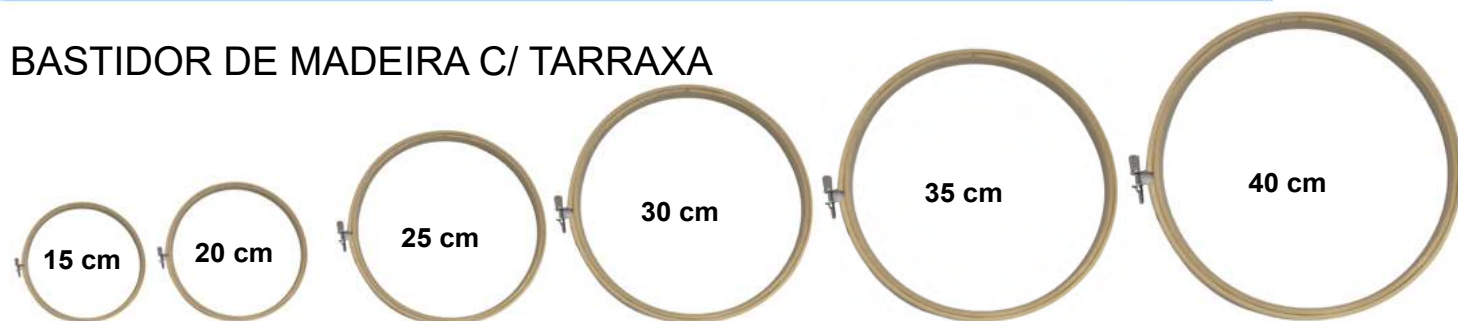

15 cm	REF: AR0015-B BASTIDOR DE MADEIRA C/ TARRAXA - 15 CM CÓDIGO DE BARRA: 7908265006153 NCM: 4421.91.00 IPI: 0%	CX MASTER 100 UNID R\$ 5,25 PREÇO UNITÁRIO	FRAÇÃO 10 UNID R\$ 5,80 PREÇO UNITÁRIO
20 cm	REF: AR0020 BASTIDOR DE MADEIRA C/ TARRAXA - 20 CM CÓDIGO DE BARRA: 7908221649806 NCM: 4421.91.00 IPI: 0% 7908221603112	FRAÇÃO 10 UNID ESGOTADO PREÇO UNITÁRIO	
25 cm	REF: AR0025 BASTIDOR DE MADEIRA C/ TARRAXA - 25 CM CÓDIGO DE BARRA: 7908221649806 NCM: 4421.91.00 IPI: 0%	CX MASTER 100 UNID ESGOTADO PREÇO UNITÁRIO	FRAÇÃO 10 UNID ESGOTADO PREÇO UNITÁRIO
30 cm	REF: AR0030 BASTIDOR DE MADEIRA C/ TARRAXA - 30 CM CÓDIGO DE BARRA: 7908221637056 NCM: 4421.91.00 IPI: 0%	CX MASTER 100 UNID R\$ 7,95 PREÇO UNITÁRIO	FRAÇÃO 10 UNID R\$ 8,75 PREÇO UNITÁRIO
35 cm	REF: AR0035 BASTIDOR DE MADEIRA C/ TARRAXA - 35 CM CÓDIGO DE BARRA: 7908265006177 NCM: 4421.91.00 IPI: 0%	CX MASTER 100 UNID R\$ 8,95 PREÇO UNITÁRIO	FRAÇÃO 10 UNID R\$ 9,85 PREÇO UNITÁRIO
40 cm	REF: AR0040 BASTIDOR DE MADEIRA C/ TARRAXA - 40 CM CÓDIGO DE BARRA: 7908221637070 NCM: 4421.91.00 IPI: 0%	CX MASTER 100 UNID R\$ 10,90 PREÇO UNITÁRIO	FRAÇÃO 10 UNID R\$ 12,00 PREÇO UNITÁRIO

BASTIDOR DE PLÁSTICO C/ TARRAXA



09 cm	REF: AR21-09 BASTIDOR DE PLÁSTICO C/ TARRAXA - 9 CM CÓDIGO DE BARRA: 7908221637797 NCM: 3926.90.90 IPI: 9,75%	CX MASTER 100 UNID R\$ 4,50 PREÇO UNITÁRIO	FRAÇÃO 10 UNID R\$ 4,95 PREÇO UNITÁRIO
12 cm	REF: AR21-12 BASTIDOR DE PLÁSTICO C/ TARRAXA - 12CM CÓDIGO DE BARRA: 7908221637803 NCM: 3926.90.90 IPI: 9,75%	CX MASTER 100 UNID R\$ 4,50 PREÇO UNITÁRIO	FRAÇÃO 10 UNID R\$ 4,95 PREÇO UNITÁRIO
16 cm	REF: AR21-16 BASTIDOR DE PLÁSTICO C/ TARRAXA -16CM CÓDIGO DE BARRA: 7908221603143 NCM: 3926.90.90 IPI: 9,75%	CX MASTER 100 UNID R\$ 4,75 PREÇO UNITÁRIO	FRAÇÃO 10 UNID R\$ 5,25 PREÇO UNITÁRIO
20 cm	REF: AR21-20 BASTIDOR DE PLÁSTICO C/ TARRAXA 20 CM CÓDIGO DE BARRA: 7908221603174 NCM: 3926.90.90 IPI: 9,75%	CX MASTER 100 UNID ESGOTADO PREÇO UNITÁRIO	FRAÇÃO 10 UNID ESGOTADO PREÇO UNITÁRIO
25 cm	REF: AR21-25 BASTIDOR DE PLÁSTICO C/ TARRAXA 25 CM CÓDIGO DE BARRA: 7908221603157 NCM: 3926.90.90 IPI: 9,75%	CX MASTER 100 UNID R\$ 6,50 PREÇO UNITÁRIO	FRAÇÃO 10 UNID R\$ 7,15 PREÇO UNITÁRIO
27 cm	REF: AR21-27 BASTIDOR DE PLÁSTICO C/ TARRAXA 27 CM CÓDIGO DE BARRA: 7908221603150 NCM: 3926.90.90 IPI: 9,75%	CX MASTER 100 UNID R\$ 7,00 PREÇO UNITÁRIO	FRAÇÃO 10 UNID R\$ 7,70 PREÇO UNITÁRIO

BASTIDOR

BASTIDOR DE MADEIRA SEM TARRAXA

NCM: 4421.91.00 IPI: 0%



12 cm	REF.: AR22-12 BASTIDOR DE MADEIRA S/ TARRAXA - 12 CM CÓDIGO DE BARRA: 7908221684913	CX MASTER 162 UNID R\$ 4,35 PREÇO UNITÁRIO	FRAÇÃO 6 UNID R\$ 4,90 PREÇO UNITÁRIO
15 cm	REF.: AR22-15 BASTIDOR DE MADEIRA S/ TARRAXA - 15 CM CÓDIGO DE BARRA: 7908221684920	CX MASTER 126 UNID R\$ 4,35 PREÇO UNITÁRIO	FRAÇÃO 6 UNID R\$ 4,90 PREÇO UNITÁRIO
20 cm	REF.: AR22-20 BASTIDOR DE MADEIRA S/ TARRAXA - 20 CM CÓDIGO DE BARRA: 7908221684937	CX MASTER 108 UNID R\$ 4,50 PREÇO UNITÁRIO	FRAÇÃO 6 UNID R\$ 5,00 PREÇO UNITÁRIO
22 cm	REF.: AR22-22 BASTIDOR DE MADEIRA S/ TARRAXA - 22 CM CÓDIGO DE BARRA: 7908221684944	CX MASTER 108 UNID R\$ 4,50 PREÇO UNITÁRIO	FRAÇÃO 6 UNID R\$ 5,00 PREÇO UNITÁRIO
25 cm	REF.: AR22-25 BASTIDOR DE MADEIRA S/ TARRAXA - 25 CM CÓDIGO DE BARRA: 7908221684951	CX MASTER 108 UNID R\$ 4,50 PREÇO UNITÁRIO	FRAÇÃO 6 UNID R\$ 5,00 PREÇO UNITÁRIO
30 cm	REF.: AR22-30 BASTIDOR DE MADEIRA S/ TARRAXA - 30 CM CÓDIGO DE BARRA: 7908221684968	CX MASTER 108 UNID R\$ 5,25 PREÇO UNITÁRIO	FRAÇÃO 6 UNID R\$ 5,90 PREÇO UNITÁRIO
35 cm	REF.: AR22-35 BASTIDOR DE MADEIRA S/ TARRAXA - 35 CM CÓDIGO DE BARRA: 7908221684975	CX MASTER 66 UNID R\$ 6,10 PREÇO UNITÁRIO	FRAÇÃO 6 UNID R\$ 6,90 PREÇO UNITÁRIO
40 cm	REF.: AR22-40 BASTIDOR DE MADEIRA S/ TARRAXA - 40 CM CÓDIGO DE BARRA: 7908221684982	CX MASTER 66 UNID R\$ 6,90 PREÇO UNITÁRIO	FRAÇÃO 6 UNID R\$ 7,90 PREÇO UNITÁRIO

BASTIDORES



19 cm

REF.: AR20-19

BASTIDOR OVAL PLÁSTICO - MOLDURA - 19 x 15 CM

CÓDIGO DE BARRA :7908221638299

NCM: 3926.90.90 IPI: 9,75%

CX MASTER 100 UNID

FRAÇÃO 10 UNID

R\$ 13,00

PREÇO UNITÁRIO

R\$ 14,30

PREÇO UNITÁRIO

25 cm

REF.:AR20-25

BASTIDOR OVAL PLÁSTICO - MOLDURA - 25 x 18 CM

CÓDIGO DE BARRA: 7908221638305

NCM: 3926.90.90 IPI: 9,75%

CX MASTER 100 UNID

FRAÇÃO 10 UNID

R\$ 15,50

PREÇO UNITÁRIO

R\$ 17,05

PREÇO UNITÁRIO

29 cm

REF.: AR20-29

BASTIDOR OVAL PLÁSTICO - MOLDURA - 29 x 21,5 CM

CÓDIGO DE BARRA: 7908221638312

NCM: 3926.90.90 IPI: 9,75%

CX MASTER 100 UNID

FRAÇÃO 10 UNID

R\$ 20,65

PREÇO UNITÁRIO

R\$ 22,70

PREÇO UNITÁRIO

TELA PLÁSTICA

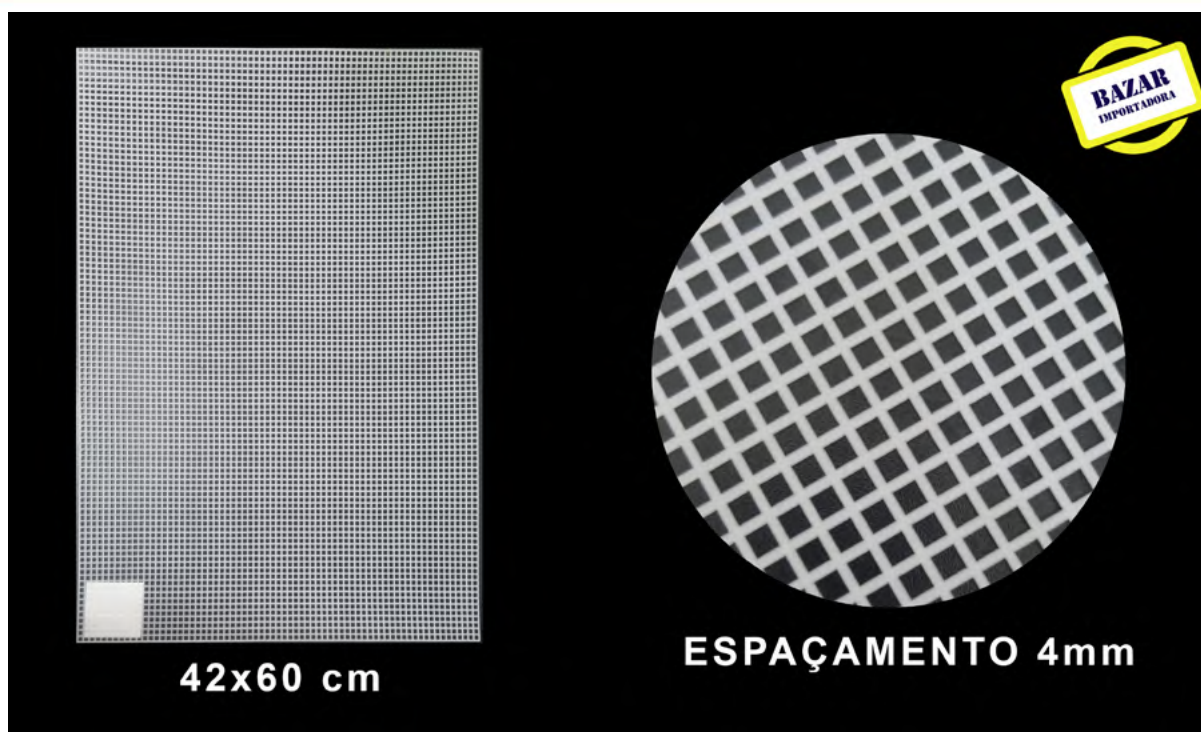

42x60 cm

ESPAÇAMENTO 4mm



REF.: AR0070

MALHA CHENILLE

TELA PLÁSTICA PARA ARTESANATO 150 g

Tamanho total 42 cm X 60 cm

Espaçamento: 4 mm

CÓDIGO DE BARRA: 7908221671784

NCM: 95059000 IPI: 13%

CX MASTER 250 UNID

FRAÇÃO 10 UNID

R\$ 7,10

PREÇO UNITÁRIO

R\$ 7,85

PREÇO UNITÁRIO



MANTA MAGNÉTICA

MANTA ADESIVA MAGNÉTICA



REF.: IMA-AD1

MANTA ADESIVA MAGNÉTICA
ROLO COM **5 m**

Comprimento: **60 cm**

Espessura: **4 mm**

CÓDIGO DE BARRA: 7908221684784

NCM: 8505.19.90 IPI: 9,75%

FRAÇÃO 5 METROS

R\$ 34,27

PREÇO DO METRO

REF.: IMA-AD2

MANTA ADESIVA MAGNÉTICA
ROLO COM **5 m**

Comprimento: **60 cm**

Espessura: **8 mm**

CÓDIGO DE BARRA: 7908221684807

NCM: 8505.19.90 IPI: 9,75%

FRAÇÃO 5 METROS

R\$ 52,35

PREÇO DO METRO

MANTA MAGNÉTICA



REF.: IMA-1

MANTA MAGNÉTICA
ROLO COM **5 m**

Comprimento: **60 cm**

Espessura: **4 mm**

CÓDIGO DE BARRA: 7908221684777

NCM: 8505.19.90 IPI: 9,75%

FRAÇÃO 5 METROS

R\$ 19,32

PREÇO DO METRO

REF.: IMA-2

MANTA MAGNÉTICA
ROLO COM **5 m**

Comprimento: **60 cm**

Espessura: **8 mm**

CÓDIGO DE BARRA: 7908221684791

NCM: 8505.19.90 IPI: 9,75%

FRAÇÃO 5 METROS

R\$ 36,77

PREÇO DO METRO

AGULHA DE SACARIA

PACOTE COM 25 UNIDADES

100% METAL

NCM: 7319.90.00 IPI: 9,75%

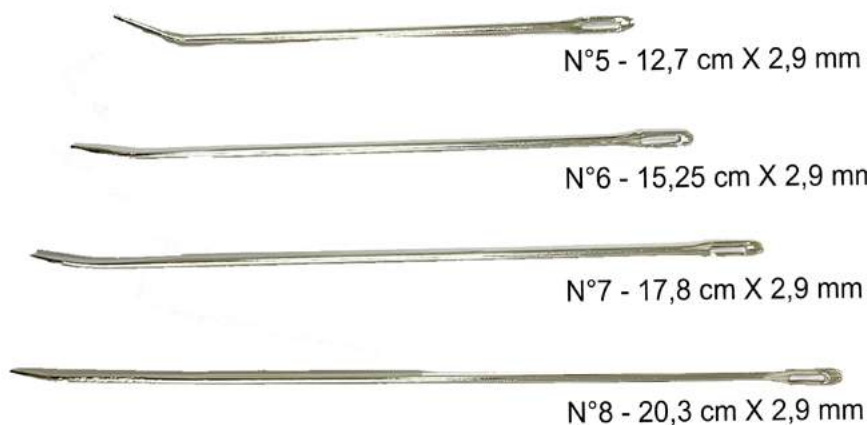

REF.: AR0013-5

N° 5 - 12,7 cm X 2,9 mm
CÓDIGO DE BARRA: 7908221683541

R\$ 18,75

PREÇO PACOTE C/ 25 UND

REF.: AR0013-6

N° 6 - 15,25 cm X 2,9 mm
CÓDIGO DE BARRA: 7908221683558

R\$ 20,00

PREÇO PACOTE C/ 25 UND

REF.: AR0013-7

N° 7 - 17,8 cm X 2,9 mm
CÓDIGO DE BARRA: 7908221683565

R\$ 22,50

PREÇO PACOTE C/ 25 UND

REF.: AR0013-8

N° 8 - 20,3 cm X 2,9 mm
CÓDIGO DE BARRA: 7908221683572

R\$ 24,75

PREÇO PACOTE C/ 25 UND

AGULHAS



Nº 7	REF.: AR2003-B7	FRAÇÃO 12 UNID
	AGULHA CROCHÊ BAMBU 14,8 CM - NÚMERO 7 CÓD.DE BARRA: 7908221608094 NCM: 4421.99.00 IPI: 0%	R\$ 1,70 PREÇO UNITÁRIO

0,6 MM	REF.: AR0666-0,6	FRAÇÃO 12 UNID
	AGULHA DE CROCHÊ 0,6 MM C/ BASE DE BAMBU PONTA DE FERRO CÓD. DE BARRA: 7908221615313 NCM: 7616.99.00 IPI: 3,25%	R\$ 2,85 PREÇO UNITÁRIO

Nº 8	REF.: AR2003-B8	FRAÇÃO 12 UNID
	AGULHA CROCHÊ BAMBU 14,8 CM - NÚMERO 8 CÓD. DE BARRA: 7908221608100 NCM: 4421.99.00 IPI: 0%	R\$ 1,70 PREÇO UNITÁRIO

0,75 MM	REF.: AR0666-0,75	FRAÇÃO 12 UNID
	AGULHA DE CROCHÊ 0,75 MM C/ BASE DE BAMBU PONTA DE FERRO CÓD. DE BARRA: 7908221615320 NCM: 7616.99.00 IPI: 3,25%	R\$ 2,85 PREÇO UNITÁRIO

Nº 9	REF.: AR2003-B9	FRAÇÃO 12 UNID
	AGULHA CROCHÊ BAMBU 14,8 CM - NÚMERO 9 CÓD. DE BARRA: 7908221608117 NCM: 4421.99.00 IPI: 0%	R\$ 1,90 PREÇO UNITÁRIO

0,9 MM	REF.: AR0666-0,9	FRAÇÃO 12 UNID
	AGULHA DE CROCHÊ 0,9 MM C/ BASE DE BAMBU PONTA DE FERRO CÓD.DE BARRA: 7908221615337 NCM: 7616.99.00 IPI:3,25%	R\$ 2,85 PREÇO UNITÁRIO

Nº 10	REF.: AR2003-B10	FRAÇÃO 12 UNID
	AGULHA CROCHÊ BAMBU 14,8 CM - NÚMERO 10 CÓD. DE BARRA: 7908221608124 NCM: 4421.99.00 IPI: 0%	R\$ 1,90 PREÇO UNITÁRIO

1,0 MM	REF.: AR0666-1,0	FRAÇÃO 12 UNID
	AGULHA DE CROCHÊ 1,00 MM C/ BASE DE BAMBU PONTA DE FERRO CÓD. DE BARRA: 7908221615344 NCM: 7616.99.00 IPI: 3,25%	R\$ 2,85 PREÇO UNITÁRIO

Nº 12	REF.: AR2003-B12	FRAÇÃO 12 UNID
	AGULHA CROCHÊ BAMBU 14,8 CM NÚMERO 12 CÓD. DE BARRA: 7908221608131 NCM: 4421.99.00 IPI: 0%	R\$ 2,00 PREÇO UNITÁRIO

1,25 MM	REF.: AR0666-1,25	FRAÇÃO 12 UNID
	AGULHA DE CROCHÊ 1,25 MM C/ BASE DE BAMBU PONTA DE FERRO CÓD. DE BARRA: 7908221615351 NCM: 7616.99.00 IPI: 3,25%	R\$ 2,85 PREÇO UNITÁRIO

1,75 MM	REF.: AR0666-1,75	FRAÇÃO 12 UNID
	AGULHA DE CROCHÊ 1,75 MM C/ BASE DE BAMBU PONTA DE FERRO CÓD.DE BARRA: 7908221615375 NCM: 7616.99.00 IPI: 3,25%	R\$ 2,85 PREÇO UNITÁRIO



0/4 - 0/6	REF.: GA146-1	FRAÇÃO 12 PCT C/ 12 UNID
	AGULHA DE CROCHÊ METAL C/ DUAS PONTAS 13CM (0/4 e 0/06) CÓD.BARRA: 7908221613562 NCM: 7319.40.00 IPI: 9,75%	R\$ 7,80 PREÇO POR PACOTE

0/3 - 0/5	REF.: GA146-2	FRAÇÃO 12 PCT C/ 12 UNID
	AGULHA DE CROCHÊ METAL C/ DUAS PONTAS 13CM (0/3 e 0/05) CÓD.BARRA: 7908221613579 NCM: 7319.40.00 IPI: 9,75%	R\$ 7,80 PREÇO POR PACOTE

0/5 - 0/6	REF.: GA146-3	FRAÇÃO 12 PCT C/ 12 UNID
	AGULHA DE CROCHÊ METAL C/ DUAS PONTAS 13CM (0/5 e 0/06) CÓD.BARRA: 7908221613586 NCM: 7319.40.00 IPI: 9,75%	R\$ 7,80 PREÇO POR PACOTE

AGULHAS



2,5 MM	REF.: AR2000-2,5	FRAÇÃO PCT C/12 UNID
	AGULHA CROCHÊ METAL 2,5 MM CÓD.BARRA: 7908221638756 NCM: 8452.30.00 IPI: 3,25%	R\$ 9,95 PREÇO POR PACOTE

3,0 MM	REF.: AR2000-3,0	FRAÇÃO PCT C/12 UNID
	AGULHA CROCHÊ METAL 3,0 MM CÓD.BARRA: 7908221638756 NCM: 8452.30.00 IPI: 3,25%	R\$ 9,95 PREÇO POR PACOTE

3,5 MM	REF.: AR2000-3,5	FRAÇÃO PCT C/12 UNID
	AGULHA CROCHÊ METAL 3,5 MM CÓD.BARRA: 7908221638732 NCM: 8452.30.00 IPI: 3,25%	R\$ 11,50 PREÇO POR PACOTE

4,5 MM	REF.: AR2000-4,5	FRAÇÃO PCT C/12 UNID
	AGULHA CROCHÊ METAL 4,5 MM CÓD.BARRA: 7908221618802 NCM: 8452.30.00 IPI: 3,25%	R\$ 16,50 PREÇO POR PACOTE

5,0 MM	REF.: AR2000-5,0	FRAÇÃO PCT C/12 UNID
	AGULHA CROCHÊ METAL 5,0 MM CÓD.BARRA: 7908221618819 NCM: 8452.30.00 IPI: 3,25%	R\$ 19,80 PREÇO POR PACOTE

5,5 MM	REF.: AR2000-5,5	FRAÇÃO PCT C/12 UNID
	AGULHA CROCHÊ METAL 5,5 MM CÓD.BARRA: 7908221618826 NCM: 8452.30.00 IPI: 3,25%	R\$ 19,80 PREÇO POR PACOTE

6,0 MM	REF.: AR2000-6,0	FRAÇÃO PCT C/12 UNID
	AGULHA CROCHÊ METAL 6,0 MM CÓD.BARRA: 7908221618833 NCM: 8452.30.00 IPI: 3,25%	R\$ 19,80 PREÇO POR PACOTE

7,0 MM	REF.: AR2000-7	FRAÇÃO PCT C/12 UNID
	AGULHA CROCHÊ METAL 7,0 MM CÓD.BARRA: 7908221684852 NCM: 8452.30.00 IPI: 3,25%	R\$ 25,00 PREÇO POR PACOTE

8,0 MM	REF.: AR2000-8	FRAÇÃO PCT C/12 UNID
	AGULHA CROCHÊ METAL 8,0 MM CÓD.BARRA: 7908221684869 NCM: 8452.30.00 IPI: 3,25%	R\$ 27,50 PREÇO POR PACOTE

9,0 MM	REF.: AR2000-9	FRAÇÃO PCT C/12 UNID
	AGULHA CROCHÊ METAL 9,0 MM CÓD.BARRA: 7908221684876 NCM: 8452.30.00 IPI: 3,25%	R\$ 29,50 PREÇO POR PACOTE



4,0 MM	REF.: AR0444-4,0	FRAÇÃO 12 UNID
	AGULHA DE CROCHÊ 4 MM C/ BASE DE BAMBU PONTA DE ALUMÍNIO CÓD. DE BARRA: 7908221615290 NCM: 7616.99.00 IPI: 3,25%	R\$ 3,20 PREÇO UNITÁRIO

4,5 MM	REF.: AR0444-4,5	FRAÇÃO 12 UNID
	AGULHA DE CROCHÊ 4,5 MM C/ BASE DE BAMBU PONTA DE ALUMÍNIO CÓD. DE BARRA: 7908221615306 NCM: 7616.99.00 IPI: 3,25%	R\$ 3,20 PREÇO UNITÁRIO



6,0 MM 35 CM	REF.: AR1620-6	FRAÇÃO PCT C/ 10 UNID
	AGULHA DE TRICÔ PLÁSTICA 6 MM - 35 CM C/ 10 UNID CÓD. BARRA: 7908221618925 NCM: 7319.90.00 IPI: 9,75%	R\$ 37,40 PREÇO POR PACOTE

6,5 MM 35 CM	REF.: AR1620-6,5	FRAÇÃO PCT C/ 10 UNID
	AGULHA DE TRICÔ PLÁSTICA 6,5 MM - 35 CM C/ 10 UNID CÓD. BARRA: 7908221618918 NCM: 7319.90.00 IPI: 9,75%	R\$ 37,40 PREÇO POR PACOTE

7,0 MM 40 CM	REF.: AR1620-7	FRAÇÃO PCT C/ 10 UNID
	AGULHA DE TRICÔ PLÁSTICA 7 MM - 40 CM C/ 10 UNID CÓD. BARRA: 7908221618932 NCM: 7319.90.00 IPI: 9,75%	R\$ 40,60 PREÇO POR PACOTE

8,0 MM 40 CM	REF.: AR1620-8	FRAÇÃO PCT C/ 10 UNID
	AGULHA DE TRICÔ PLÁSTICA 8 MM - 40 CM C/ 10 UNID CÓD. BARRA: 7908221618949 NCM: 7319.90.00 IPI: 9,75%	R\$ 40,20 PREÇO POR PACOTE

9,0 MM 40 CM	REF.: AR1620-9	FRAÇÃO PCT C/ 10 UNID
	AGULHA DE TRICÔ PLÁSTICA 9 MM - 40 CM C/ 10 UNID CÓD. BARRA: 7908221618956 NCM: 7319.90.00 IPI: 9,75%	R\$ 48,40 PREÇO POR PACOTE

10 MM 40 CM	REF.: AR1620-10	FRAÇÃO PCT C/ 10 UNID
	AGULHA DE TRICÔ PLÁSTICA 10 MM - 40 CM C/ 10 UNID CÓD. BARRA: 7908221618963 NCM: 7319.90.00 IPI: 9,75%	R\$ 51,60 PREÇO POR PACOTE

12 MM 40 CM	REF.: AR1620-12	FRAÇÃO PCT C/ 10 UNID
	AGULHA DE TRICÔ PLÁSTICA 12 MM - 40 CM C/ 10 UNID CÓD. BARRA: 7908221618970 NCM: 7319.90.00 IPI: 9,75%	R\$ 51,60 PREÇO POR PACOTE

09 MM 25 CM	REF.: AR1618-9	FRAÇÃO PCT C/ 10 UNID
	AGULHA DE TRICÔ PLÁSTICA 9 MM - 25 CM C/ 10 UNID CÓD. BARRA: 7908221618895 NCM: 7319.90.00 IPI: 9,75%	R\$ 38,40 PREÇO POR PACOTE

10 MM 25 CM	REF.: AR1618-10	FRAÇÃO PCT C/ 10 UNID
	AGULHA DE TRICÔ PLÁSTICA 10 MM - 25 CM C/ 10 UNID CÓD. BARRA: 7908221618901 NCM: 7319.90.00 IPI: 9,75%	R\$ 42,80 PREÇO POR PACOTE



4,0 MM	REF.: AR0555-4,0	FRAÇÃO 12 UNID
	AGULHA DE CROCHÊ 4,0MM C/ BASE PLÁSTICA PONTA DE ALUMÍNIO CÓD. DE BARRA: 7908221615245 NCM: 7319.90.00 IPI: 9,75%	R\$ 2,90 PREÇO UNITÁRIO

4,5 MM	REF.: AR0555-4,5	FRAÇÃO 12 UNID
	AGULHA DE CROCHÊ 4,5 MM C/ BASE PLÁSTICA PONTA DE ALUMÍNIO CÓD. DE BARRA: 7908221615252 NCM: 7319.90.00 IPI: 9,75%	R\$ 3,20 PREÇO UNITÁRIO

AGULHAS



REF.: AR0519

KIT AGULHAS 2 PEÇAS - 17 CM
CÓDIGO DE BARRA: 7908221609275
NCM: 8452.30.00 IPI: 3,25%
FRAÇÃO 12 KITS

R\$ 2,35

PREÇO KIT



REF.: AR0521

KIT AGULHAS 4 PEÇAS 15, 12 e 10CM
CÓDIGO DE BARRA: 7908221607868
NCM: 8452.30.00 IPI: 3,25%
CX MAST.1440 KITS FRAÇÃO 12 KITS

R\$ 4,80

PREÇO KIT

R\$ 5,20

PREÇO KIT



REF.: AR0520

AGULHAS - KIT COM 4 UND
CÓDIGO DE BARRA: 7908221609268
NCM: 73199000 IPI: 9,75%
FRAÇÃO KIT

R\$ 2,20

PREÇO KIT



REF.: AR0520-4

AGULHAS 9 cm - KIT COM 7 UND
CÓDIGO DE BARRA: 7908221654633
NCM: 73199000 IPI: 9,75%
FRAÇÃO 35 UND

R\$ 1,50

PREÇO KIT



REF.: AR0520-3

AGULHAS 5.5 cm - KIT COM 10 UND
CÓDIGO DE BARRA: 7908221654619
NCM: 73199000 IPI: 9,75%
FRAÇÃO 50 KITS

R\$ 1,00

PREÇO KIT



REF.: AR0520-2

AGULHAS - KIT COM 6 UND
CÓDIGO DE BARRA: 7908221654602
NCM: 73199000 IPI: 9,75%
FRAÇÃO 50 KITS

R\$ 1,40

PREÇO KIT



REF.: AR0520-5

KIT AGULHAS CURVAS - 3 UNIDADES
CÓDIGO DE BARRA: 7908221684401
NCM: 73199000 IPI: 9,75%
FRAÇÃO

R\$ 1,40

PREÇO KIT



REF.: AR2024-92

KIT AGULHAS 10 cm - 5 UND
CÓDIGO DE BARRA: 7908221654640
NCM: 73199000 IPI: 9,75%
FRAÇÃO KIT

R\$ 1,20

PREÇO KIT



REF.: AR1000

KIT AGULHEIRO
CÓDIGO DE BARRA: 7908221615160
NCM: 73199000 IPI: 9,75%

CX MASTER 1440 KITS

FRAÇÃO 12 KITS

R\$ 0,65

PREÇO KIT

R\$ 0,75

PREÇO KIT



REF.: AR2024-83

KIT AGULHAS - 24 DISCOS
CÓDIGO DE BARRA: 7908221654596
NCM: 73199000 IPI: 9,75%

CX MASTER 1440 DISCOS

FRAÇÃO KIT C/ 24 DISCOS

R\$ 0,80

PREÇO DO DISCO

R\$ 0,90

PREÇO DO DISCO



REF.: AR2024-34

KIT 10 AGULHAS
CÓDIGO DE BARRA: 7908221654312
NCM: 73199000 IPI: 9,75%

FRAÇÃO 36 KITS

R\$ 1,75

PREÇO KIT



0,012mm - 17cm

REF.: AR2024-184

CAPINHA DE PVC PARA AGULHA DE CROCHÊ
CÓDIGO DE BARRA: 7908221655265
NCM: 39232910 IPI: 9,75%

FRAÇÃO 100 UND

R\$ 12,00

PREÇO PACOTE



AGULHAS

AGULHA DE MÁQUINA ESPECIAL

KIT COM 10 AGULHAS

NCM: 8452.30.00 IPI: 3,25%

CX MASTER 1000 CARDS

FRAÇÃO 10 CARDS

R\$ 2,90

PREÇO CARD

R\$ 3,25

PREÇO CARD



N°09



N°11



N°14



N°16

REF: AR2045-9E

AGULHA N°9

CÓD.BARRA: 7908221614415

REF: AR2045-11E

AGULHA N°11

CÓD.BARRA: 7908221614422

REF: AR2045-14E

AGULHA N°14

CÓD.BARRA: 7908221614439

REF: AR2045-16E

AGULHA N°16

CÓD.BARRA: 7908221618734



KIT AGULHEIRO
55 AGULHAS



REF: AR1000-1

KIT AGULHEIRO - 55 AGULHAS

CÓDIGO DE BARRA: 7908221684432

NCM: 7319.90.00 IPI: 9,75%

FRAÇÃO

R\$ 2,60

PREÇO CARD



AGULHA DE MÃO PARA CEGO



REF: AR0518

AGULHA DE MÃO PARA CEGO

CÓDIGO DE BARRA: 7908221684425

NCM: 7319.90.00 IPI: 9,75%

FRAÇÃO 36 CARDS

R\$ 1,60

PREÇO CARD



REF: AR0019

AGULHEIRO CESTINHA - 19 PEÇAS

CÓDIGO DE BARRA: 7908221618628

NCM: 7319.90.00 IPI: 9,75%

FRAÇÃO 72 KITS

R\$ 0,60

PREÇO KIT

BAZAR
IMPORTADORA

AGULHAS



REF.: AR2024-209

AGULHA DE FELTRO DE PLÁSTICO
CÓDIGO DE BARRA: 7908221657276
NCM: 39269090 IPI: 9,75%

FRAÇÃO 12 UND

R\$ 11,90

PREÇO UNIDADE



REF.: AR2024-210

AGULHA DE FELTRAGEM DE PLÁSTICO
CÓDIGO DE BARRA: 7908221657283
NCM: 39269090 IPI: 9,75%

FRAÇÃO 12 UND

R\$ 11,90

PREÇO UNIDADE



REF.: AR2002-P12

AGULHA DE CROCHÊ PLÁSTICA 14,5CM- N. 12
CÓDIGO DE BARRA: 7908221608841
NCM: 3926.90.90 IPI: 9,75%

FRAÇÃO 12 UNID

R\$ 2,00

PREÇO UNITÁRIO



REF.: AR0522

KIT AGULHA 3 UNID (12,11 e 10 cm)
CÓDIGO DE BARRA: 7908221614736
NCM: 39269090 IPI: 9,75%

FRAÇÃO 20 KITS

R\$ 0,80

PREÇO KIT COM 3 UND



REF.: AR2024-207

AGULHA PLÁSTICO 1000 UND - 9 cm
CÓDIGO DE BARRA: 7908221657269
NCM: 39269090 IPI: 9,75%

FRAÇÃO PCT C/ 1000 UND

R\$ 40,00

PREÇO PACOTE

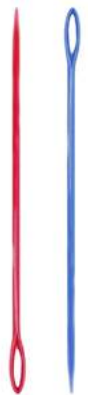

REF.: AR2024-205

AGULHA DE PLÁSTICO 15 cm - 1000 UND
CÓDIGO DE BARRA: 7908221657252
NCM: 39269090 IPI: 9,75%

FRAÇÃO PCT C/ 1000 UND

R\$ 75,00

PREÇO PACOTE

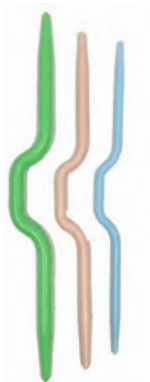

REF.: AR0522-2

KIT AGULHA PLÁSTICA - 9 cm - 10cm -11cm
CÓDIGO DE BARRA: 7908221688119
NCM: 39269090 IPI: 9,75%

FRAÇÃO 50 KITS

R\$ 0,80

PREÇO KIT COM 3 UND



REF.: AR2024-212

AGULHÃO FURADOR DE TECIDO
CABO PLÁSTICO - 12 cm
CÓDIGO DE BARRA: 7908221657306
NCM: 73199000 IPI: 9,75%

FRAÇÃO 100 UND

R\$ 0,40

PREÇO UNIDADE



REF.: AR2024-211

AGULHÃO FURADOR DE TECIDO
CABO MADEIRA - 15.3 cm
CÓDIGO DE BARRA: 7908221657290
NCM: 73199000 IPI: 9,75%

FRAÇÃO 24 UND

R\$ 1,60

PREÇO UNIDADE

ALFINETES



REF.: AR2024-224

CAIXA DE ALFINETE 100PCS - 38MM
CÓDIGO DE BARRA: 7908221657146
NCM: 73199000 IPI: 9,75%

FRAÇÃO 20 CAIXAS

R\$ 1,70

PREÇO CAIXA

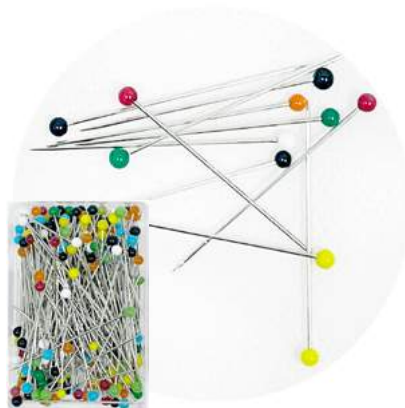

REF.: AR2024-227

CAIXA DE ALFINETE 200 UND 38 mm
CABEÇA DE VIDRO
CÓDIGO DE BARRA: 7908221657078
NCM: 73199000 IPI: 9,75%

FRAÇÃO 20 CAIXAS

R\$ 9,95

PREÇO CAIXA

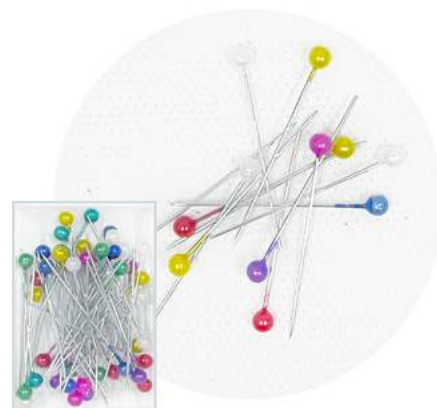

REF.: AR0011-ABG

CAIXA DE ALFINETE 50 UND
CÓDIGO DE BARRA: 7908221637766
NCM: 73194000 IPI: 9,75%

FRAÇÃO 20 CAIXAS

R\$ 1,30

PREÇO CAIXA

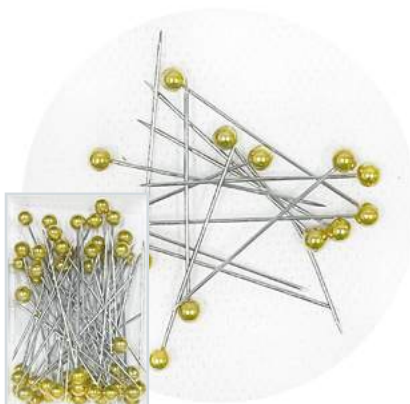

REF.: AR2024-45

KIT ALFINETE DOURADO - 50 UND
CÓDIGO DE BARRA: 7908221654336
NCM: 73194000 IPI: 9,75%

FRAÇÃO 20 CAIXAS

R\$ 1,60

PREÇO CAIXA



REF.: AR2024-46

KIT ALFINETE PRATA - 50 UND
CÓDIGO DE BARRA: 7908221654343
NCM: 73194000 IPI: 9,75%

FRAÇÃO 20 CAIXAS

R\$ 1,60

PREÇO CAIXA



REF.: AR2024-28

KIT DE ALFINETE - 80 UND
CÓDIGO DE BARRA: 7908221654282
NCM: 73199000 IPI: 9,75%

FRAÇÃO 20 KITS

R\$ 2,70

PREÇO KIT



REF.: AR2024-223

CAIXA DE ALFINETE 100PCS - 38MM
CÓDIGO DE BARRA: 7908221657139
NCM: 73199000 IPI: 9,75%

FRAÇÃO 20 CAIXAS

R\$ 2,50

PREÇO CAIXA



REF.: AR2024-90

CAIXA DE ALFINETE - 50PCS
CÓDIGO DE BARRA: 7908221654626
NCM: 73194000 IPI: 9,75%

FRAÇÃO 10 CAIXAS

R\$ 6,25

PREÇO CAIXA



REF.: AR2024-31

KIT DE ALFINETE - CAIXA COM 50 UND
CÓDIGO DE BARRA: 7908221654305
NCM: 73199000 IPI: 9,75%

FRAÇÃO 20 CAIXAS

R\$ 4,60

PREÇO CAIXA

ALFINETES



REF.: AR2024-24

KIT ALFINETE PATCHWORK - 5 CM
KIT C/ 12 DISCOS C/ 30 ALFINETES CADA
CÓDIGO DE BARRA: 7908221654244
NCM: 73194000 IPI: 9,75%

CX MASTER 120 KITS FRAÇÃO 3 KITS

R\$ 14,95
PREÇO KIT

R\$ 16,50
PREÇO KIT



REF.: AR2024-26

KIT ALFINETE PATCHWORK - 5 CM
KIT C/ 12 DISCOS C/ 30 ALFINETES CADA
CÓDIGO DE BARRA: 7908221654268
NCM: 73194000 IPI: 9,75%

CX MASTER 120 KITS FRAÇÃO 3 KITS

R\$ 14,95
PREÇO KIT

R\$ 16,50
PREÇO KIT



REF.: AR0011

KIT ALFINETE CABECA COLORIDA - 3 CM
KIT C/ 12 DISCOS C/ 40 ALFINETES CADA
CÓDIGO DE BARRA: 7908221613555
NCM: 73199000 IPI: 9,75%

CX MASTER 120 KITS FRAÇÃO 3 KITS

R\$ 6,30
PREÇO KIT

R\$ 6,95
PREÇO KIT



REF.: AR2024-22

KIT ALFINETE CABECA COLOR PREMIUM - 4 CM
KIT C/ 12 DISCOS C/ 40 ALFINETES CADA
CÓDIGO DE BARRA: 7908221654237
NCM: 73194000 IPI: 9,75%

CX MASTER 120 KITS FRAÇÃO 3 KITS

R\$ 9,25
PREÇO KIT

R\$ 10,95
PREÇO KIT



REF.: AR0014

ALFINETE PATCHWORKDISCO 1X30
APROX.5,5 CM
CÓDIGO DE BARRA: 7908221615382
NCM: 7319.90.00 IPI: 9,75%

FRAÇÃO 12 DISCOS

R\$ 1,45
PREÇO DISCO



REF.: AR2024-226

CAIXA DE ALFINETE 50PCS -
2 MOD DISPONÍVEIS
CÓDIGO DE BARRA: 7908221657061
NCM: 73199000 IPI: 9,75%

FRAÇÃO 20 CAIXAS DO MSM MODELO

R\$ 4,50
PREÇO CAIXA



REF.: AR140-1

CAIXA DE ALFINETE 100 UNID - 32 mm X 0,25 mm
CÓDIGO DE BARRA: 7908221672224
NCM: 7319.40.00 IPI: 9,75%

CX MASTER 720 UNID FRAÇÃO 24 UNID

R\$ 2,80
PREÇO UNID

R\$ 3,10
PREÇO UNID



REF.: GA140

POTINHO DE ALFINETE 3.8 cm - 25 gramas
CÓDIGO DE BARRA: 7908221654367
NCM: 73194000 IPI: 9,75%

CX MASTER 600 UND FRAÇÃO 12 UNID

R\$ 2,30
PREÇO UNIDADE

R\$ 2,60
PREÇO UNIDADE



REF.: AR2024-222

KIT DE ALFINETE - 80PCS - 38 mm
CÓDIGO DE BARRA: 7908221657122
NCM: 73199000 IPI: 9,75%

FRAÇÃO 12 KITS

R\$ 7,95
PREÇO 1 TUBO COM 80 ALFINETES

ALFINETES

ALFINETE DE METAL
N°29



ALFINETE DE METAL
N°26



PACOTE COM 200 ALFINETES
33 mm



REF.: AR0011-S1

ALFINETE DE METAL N°29 - 50 g
CÓDIGO DE BARRA: 7908221684814
NCM: 7319.90.00 IPI: 9,75%

FRAÇÃO 12 KITS

R\$ 2,90
PREÇO KIT

REF.: AR0011-S2

ALFINETE DE METAL N°26 - 50 g
CÓDIGO DE BARRA:
NCM: 7319.90.00 IPI: 9,75%

FRAÇÃO 12 KITS

R\$ 2,90
PREÇO KIT

REF.: GA140-2

KIT ALFINETE COM 200 PEÇA - 33 mm
CÓDIGO DE BARRA: 7908221683480
NCM: 7319.40.00 IPI: 9,75%

CX MASTER 480 KITS FRAÇÃO 12 KITS

R\$ 1,95
PREÇO KIT

R\$ 2,15
PREÇO KIT

KIT ALFINETE
3 DISCOS
40 ALFINETES POR DISCO



REF.: AR0011-K3

KIT ALFINETE DE PATCHWORK
3 DISCOS C/ 40 ALFINETES CADA
CÓDIGO DE BARRA: 7908221684838
NCM: 7319.40.00 IPI: 9,75%

FRAÇÃO 12 CARDS

R\$ 3,00
PREÇO CARD

REF.: AR0011-F

KIT ALFINETE CABEÇA FLOR - 5,2 cm
50 UNIDADES POR KIT
CÓDIGO DE BARRA: 7908221684470
NCM: 7319.90.00 IPI: 9,75%

CX MASTER 500 KITS FRAÇÃO 20 KITS

R\$ 3,70
PREÇO KIT

R\$ 4,05
PREÇO KIT

REF.: AR0011-P

KIT ALFINETE CABEÇA TULIPA - 5,2 cm
100 UNIDADES POR KIT
CÓDIGO DE BARRA: 7908221684487
NCM: 7319.90.00 IPI: 9,75%

CX MASTER 500 KITS FRAÇÃO 20 KITS

R\$ 6,10
PREÇO KIT

R\$ 6,70
PREÇO KIT



REF.: AR0011-U

KIT ALFINETE CABEÇA URSO - 5,2 cm
100 UNIDADES POR KIT
CÓDIGO DE BARRA: 7908221684494
NCM: 7319.90.00 IPI: 9,75%

CX MASTER 500 KITS FRAÇÃO 20 KITS

R\$ 6,10
PREÇO KIT

R\$ 6,70
PREÇO KIT



ALFINETES



REF.: AR2024-77

ALFINETE DE TRICÔ - 100PCS - 19,5cm
CÓDIGO DE BARRA: 7908221657207
NCM: 73194000 IPI: 9,75%

CX MASTER 3000 UND FRAÇÃO 100 UND

R\$ 1,35
PREÇO UNIDADE

R\$ 1,50
PREÇO UNIDADE

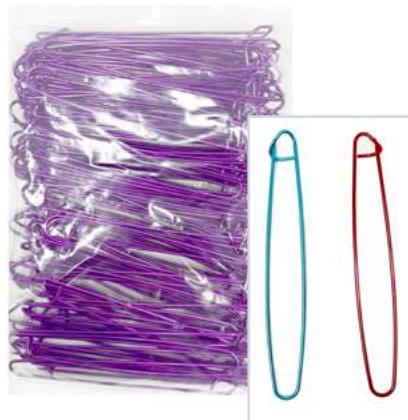

REF.: AR2024-76

ALFINETE DE TRICÔ - 100PCS - 15cm
CÓDIGO DE BARRA: 7908221657191
NCM: 73194000 IPI: 9,75%

CX MASTER 3000 UND FRAÇÃO 100 UND

R\$ 1,10
PREÇO UNIDADE

R\$ 1,25
PREÇO UNIDADE



7 cm

REF.: AR0155-1

PORTA AGULHA - 7 CM
CÓDIGO DE BARRA: 7908221657474
NCM: 63079090 IPI: 0%

FRAÇÃO 12 UND

R\$ 7,40
PREÇO UNIDADE

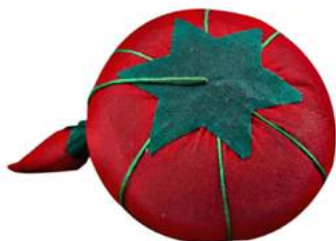

REF.: AR0155-P

PORTA AGULHA E ALFINETES PEQUENO - 4 CM
CÓDIGO DE BARRA: 7908221615108
NCM: 63079090 IPI: 0%

CX MASTER 3600 UND FRAÇÃO 12 UND

R\$ 1,25
PREÇO UNIDADE

R\$ 1,40
PREÇO UNIDADE



REF.: AR0155-M

PORTA AGULHA E ALFINETES MÉDIO - 5 CM
CÓDIGO DE BARRA: 7908221615115
NCM: 63079090 IPI: 0%

CX MASTER 1200 UND FRAÇÃO 12 UND

R\$ 1,45
PREÇO UNIDADE

R\$ 1,60
PREÇO UNIDADE



REF.: AR0155-G

PORTA AGULHA E ALFINETE GRANDE - 7 CM
CÓDIGO DE BARRA: 7908221615122
NCM: 63079090 IPI: 0%

CX MASTER 500 UND FRAÇÃO 12 UND

R\$ 2,10
PREÇO UNIDADE

R\$ 2,30
PREÇO UNIDADE

POSSUI ÍMÃ



REF.: AR2024-93

SUPORTE PARA AGULHA COM ÍMÃ
CÓDIGO DE BARRA: 7908221654657
NCM: 39269090 IPI: 9,75%

FRAÇÃO UNIDADE

R\$ 5,50
PREÇO UNIDADE



REF.: AR0900

PULSEIRA MAGNÉTICA PARA AGULHA
CÓDIGO DE BARRA: 7908221672606
NCM: 8505.19.90 IPI: 9,75%

FRAÇÃO 12 UNID MSM COR

R\$ 9,85
PREÇO UNITÁRIO



REF.: AR0012

PASSADOR DE LINHA - 3 cm
PACOTE COM 2000 UNIDADES
CÓDIGO DE BARRA: 7908221637780
NCM: 7319.90.00 IPI: 9,75%

FRAÇÃO PACOTE

R\$ 110,00
PREÇO PACOTE

PASSADORES



REF.: AR0012-4

PASSADOR DE LINHA 6,7 cm - 100 UND
CÓDIGO DE BARRA: 7908221657115
NCM: 73199000 IPI: 9,75%

FRAÇÃO PACOTE C/ 100 UND

R\$ 44,00

PREÇO PACOTE



REF.: AR0012-1

PASSADOR DE LINHA 100PCS - 4 cm
CÓDIGO DE BARRA: 7908221657085
NCM: 73199000 IPI: 9,75%

FRAÇÃO PACOTE C/ 100 UND

R\$ 19,50

PREÇO PACOTE



REF.: AR0012-3

PASSADOR DE LINHA - PACOTE C/ 100 UNIDADES
CÓDIGO DE BARRA:
NCM: 7319.90.00 IPI: 9,75%

FRAÇÃO PACOTE

R\$ 17,00

PREÇO PACOTE



REF.: AR0141

ABRIDOR CASA PEQUENO - 9 cm
CÓDIGO DE BARRA: 7908221615399
NCM: 73199000 IPI: 9,75%

CX MASTER 5000 UND FRAÇÃO 100 UND

R\$ 0,50

PREÇO UNIDADE

R\$ 0,55

PREÇO UNIDADE



REF.: AR100095

ABRIDOR CASA GRANDE - 14,5cm
CÓDIGO DE BARRA: 7908221618642
NCM: 73199000 IPI: 9,75%

CX MASTER 2500 UND FRAÇÃO 50 UND

R\$ 1,10

PREÇO UNIDADE

R\$ 1,20

PREÇO UNIDADE



REF.: AR0141-G

ABRIDOR DE CASA GRANDE - 13 CM
CÓDIGO DE BARRA: 7908221615153
NCM: 7319.90.00 IPI: 9,75%

FRAÇÃO 50 UNID.

R\$ 1,20

PREÇO UNITÁRIO



PESCADOR

PINÇA

REF.: AR2024-213

PINÇA COM PESCADOR DE METAL - 18CM
CÓDIGO DE BARRA: 7908221657238
NCM: 82032090 IPI: 5,20%

FRAÇÃO 100 UND

ESGOTADO

PREÇO UNIDADE



REF.: AR0018-P

PINÇA DE OVERLOCK 15 cm
CÓDIGO DE BARRA: 7908221615405
NCM: 8203.20.90 IPI: 5,20%

FRAÇÃO 100 UND

R\$ 1,60

PREÇO UNITÁRIO



REF.: GA17

PASSADOR DE ELÁSTICO - 8 cm
CÓDIGO DE BARRA: 7908221684203
NCM: 9505.90.00 IPI: 13%

FRAÇÃO 50 UND

R\$ 0,65

PREÇO UNIDADE



BOBINAS



REF: AR0142-2

BOBINA BAIXA DE PLÁSTICA 0.8X2CM - 200 UND
CÓDIGO DE BARRA: 7908221614323
NCM: 39269090 IPI: 9,75%

FRAÇÃO PACOTE C/ 200 UND

R\$ 25,00

PREÇO PACOTE



REF: AR0142-3

BOBINA PLÁSTICA 1X2CM - 200 UND
CÓDIGO DE BARRA: 7908221614330
NCM: 39269090 IPI: 9,75%

FRAÇÃO PACOTE

R\$ 24,00

PREÇO PACOTE



REF: AR2024-42

BOBINA BAIXA DE METAL 2X0.8CM - 100 UND
CÓDIGO DE BARRA: 7908221654893
NCM: 73199000 IPI: 9,75%

CX MASTER 5000 UND

FRAÇÃO 100 UND

R\$ 59,00

PREÇO PACOTE

R\$ 65,00

PREÇO PACOTE



REF: AR0142-5

BOBINA PLÁSTICA TRANSPARENTE - 2*1CM - 200PCS
CÓDIGO DE BARRA: 7908221655302
NCM: 39234000 IPI: 6,50%

FRAÇÃO PACOTE

R\$ 17,90

PREÇO PACOTE

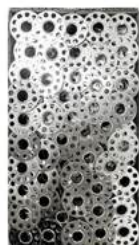

REF: AR2024-41

BOBINA DE METAL 2 cm X 1 cm - 1X200
CÓDIGO DE BARRA: 7908221654886
NCM: 39269090 IPI: 9,75%

CX MASTER 25 KITS

FRAÇÃO KIT

R\$ 36,70

PREÇO KIT

R\$ 41,00

PREÇO KIT



REF: AR0142-6

BOBINA METAL INDUSTRIAL BAIXA COM CORTE
20 mm X 8 mm
CÓDIGO DE BARRA: 7908221688331
NCM: 7319.90.00 IPI: 9,75%

FRAÇÃO CAIXA C/ 100 UND

R\$ 0,36

PREÇO UNIDADE



BOBINAS

CAIXA DE BOBINA DIREITA
20 mm



REF.: AR0142-7

CAIXA DE BOBINA DIREITA DE METAL - 20 mm

CÓDIGO DE BARRA: 7908221688348

NCM: 7319.90.00 IPI: 9,75%

FRAÇÃO CAIXA C/ 50 UND

R\$ 4,62

PREÇO UNIDADE

CAIXA DE BOBINA ESQUERDA
20 mm



REF.: AR0142-8

CAIXA DE BOBINA ESQUERDA DE METAL - 20 mm

CÓDIGO DE BARRA: 7908221688355

NCM: 7319.90.00 IPI: 9,75%

FRAÇÃO CAIXA C/ 50 UND

R\$ 5,48

PREÇO CAIXA

CAIXA ESTOJO PARA BOBINA DE MÁQUINA
ESPAÇO PARA 25 BOBINAS
12 cm X 9,5 cm X 2,5 cm



REF.: PL0027

CAIXA ESTOJO DE BOBINAS DE MÁQUINA

CÓDIGO DE BARRA: 7908221688126

NCM: 3924.90.00 IPI: 6,50%

FRAÇÃO UNIDADE

R\$ 3,25

PREÇO UNITÁRIO

CORTE E COSTURA

KIT COSTURA



REF.: AR0198

KIT COSTURA MOD. 1 - 37 PEÇAS

CÓDIGO DE BARRA: 7908221614125

NCM: 9605.00.00 IPI: 6,50%

CX MASTER 240 KITS

FRAÇÃO 12 UNID

R\$ 3,55

PREÇO KIT

R\$ 3,90

PREÇO KIT



REF.: AR0198-3

KIT COSTURA MOD. 3 - 21 PEÇAS

CÓDIGO DE BARRA: 7908221684845

NCM: 9605.00.00 IPI: 6,50%

FRAÇÃO KIT

R\$ 14,50

PREÇO KIT



CORES: AZUL, ROSA E AMARELO

REF.: AR0198-4

KIT DE COSTURA MOD. 4 - 20 PEÇAS

CÓDIGO DE BARRA: 7908221686597

NCM: 9605.00.00 IPI: 6,50%

CX MASTER 500 KITS

FRAÇÃO KIT

R\$ 5,15

PREÇO KIT

R\$ 5,60

PREÇO KIT



REF.: AR0198-5

KIT DE COSTURA MOD.5 - 26 PEÇAS

CÓDIGO DE BARRA: 7908221686603

NCM: 9605.00.00 IPI: 6,50%

CX MASTER 180 KITS

FRAÇÃO KIT

R\$ 4,20

PREÇO KIT

R\$ 4,65

PREÇO KIT

CORTE E COSTURA



MARCADOR DE PONTO PARA CROCHÊ

NCM: 3926.90.90 IPI: 9,75%

REF.: AR2024-39

PACOTE COM 100 UNIDADES
CÓDIGO DE BARRA: 7908221654886

R\$ 2,35
PREÇO PACOTE

REF.: AR2024-39-1

PACOTE COM 1000 UNIDADES
CÓDIGO DE BARRA: 7908221688294

ESGOTADO
PREÇO PACOTE



REF.: AR0170

TESOURA TECELÃO 12 cm
CÓDIGO DE BARRA: 7908221614408
NCM: 9505.90.00 IPI: 13%

CX MASTER 720 UND **FRAÇÃO 12 UND**

R\$ 2,90
PREÇO UNITÁRIO

R\$ 3,20
PREÇO UNITÁRIO

REF.: ART01

TESOURA TECELÃO 10,5 cm X 2,5 cm
CÓDIGO DE BARRA: 7908221615412
NCM: 8213.00.00 IPI: 7,80%

CX MASTER 1440 UND **FRAÇÃO 12 UND**

R\$ 1,10
PREÇO UNIDADE

R\$ 1,20
PREÇO UNIDADE

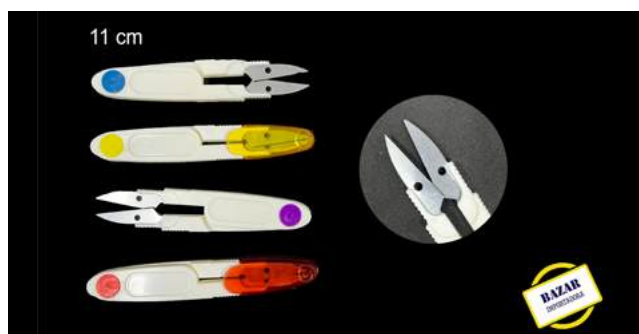

REF.: AR0170-2

TESOURA TECELÃO - 11 cm
CÓDIGO DE BARRA: 7908221684227
NCM: 9505.90.00 IPI: 13%

CX MASTER 1200 UND **FRAÇÃO 12 UND**

R\$ 2,00
PREÇO UNITÁRIO

R\$ 2,25
PREÇO UNITÁRIO

CORTE E COSTURA



REF: AR0110

DEDAL DE METAL 1x100 DOURADO
CÓDIGO DE BARRA: 7908221613593
NCM: 7319.90.00 IPI: 9,75%

FRAÇÃO PCT C/ 100 UNID

R\$ 10,00

PREÇO PACOTE



2,3 cm X 1,5 cm



REF: AR0110-4

DEDAL DE METAL - 2,3 cm X 1,5 cm
CÓDIGO DE BARRA: 7908221684142
NCM: 7319.90.00 IPI: 9,75%

CX MASTER 4000 UND

R\$ 1,15

PREÇO UNITÁRIO



REF: AR0110-2

DEDAL DE METAL 1,5 cm - 100 UND
CÓDIGO DE BARRA: 7908221657221
NCM: 73199000 IPI: 9,75%

FRAÇÃO PACOTE C/ 100 UNID

R\$ 34,90

PREÇO PACOTE



DEDAL CORTADOR DE LINHA



REF: AR0110-5

DEDAL CORTADOR DE LINHA - 2,9 cm X 1,8 cm
CÓDIGO DE BARRA: 7908221684166
NCM: 3926.90.90 IPI: 9,75%

FRAÇÃO PCT C/ 100 UND

R\$ 55,00

PREÇO PACOTE

CORTE E COSTURA



REF.: AR0139-1
 CARRETILHA P/ COSTURA CABO MADEIRA 14,5cm
 CÓDIGO DE BARRA: 7908221613616
 NCM: 82055100 IPI: 5,20%

FRAÇÃO 12 UND

R\$ 1,55
 PREÇO UNIDADE



REF.: AR2024-50
 CARRETILHA P/COSTURA CABO PLÁSTICO 14,5cm
 CÓDIGO DE BARRA: 7908221654350
 NCM: 82055100 IPI: 5,20%

CX MASTER 1200 UND FRAÇÃO 12 UND

ESGOTADO **ESGOTADO**
 PREÇO UNIDADE PREÇO UNIDADE



REF.: AR3000-1
 CORTADOR CIRCULAR DE FERRO 16cm
 CÓDIGO DE BARRA: 7908221630729
 NCM: 82119390 IPI: 7,80%

CX MASTER 240 UND FRAÇÃO 12 UND

R\$ 18,85 **R\$ 20,75**
 PREÇO UNIDADE PREÇO UNIDADE



REF.: AR6000-2
 ESTILETE - 14 cm - CARD C/ 12 UND
 CÓDIGO DE BARRA: 7908221668135
 NCM: 82119390 IPI: 7,80%

CX MASTER 1200 UND FRAÇÃO 12 UND

R\$ 1,25 **R\$ 1,40**
 PREÇO UNIDADE PREÇO UNIDADE



REF.: AR6000-3
 ESTILETE LÂMINA DE METAL - 7,5 cm
 CÓDIGO DE BARRA: 7908221668142
 NCM: 82119390 IPI: 7,80 %

CX MASTER 1200 UNID FRAÇÃO 12 UNID MIX

R\$ 1,15 **R\$ 1,30**
 PREÇO UNIDADE PREÇO UNIDADE



REF.: AR6000-1
 ESTILETE - 12,5 cm - CARD C/ 12 UND
 CÓDIGO DE BARRA: 7908221668128
 NCM: 82119390 IPI: 7,80%

CX MASTER 1200 UND FRAÇÃO 12 UND

R\$ 0,80 **R\$ 0,90**
 PREÇO UNIDADE PREÇO UNIDADE



REF.: AR0136-B
 FITA MÉTRICA VAI E VOLTA BICHOS 1,5 m
 CÓDIGO DE BARRA: 7908221684548
 NCM: 9017.80.10 IPI: 9,75%

CX MASTER 1000 UNID FRAÇÃO 12 UNID IGUAIS

R\$ 3,10 **R\$ 3,45**
 PREÇO UNIDADE PREÇO UNIDADE



REF.: LB0070-9
 FURADOR DE EVA - 9CM - C/ CORTE 3,5 CM
 CÓDIGO DE BARRA: 7908221617799
 NCM: 8441.80.00 IPI: 9,75%

FRAÇÃO UNIDADE MOD. DIVERSOS

R\$ 24,85
 PREÇO UNITÁRIO

CORTE E COSTURA



REF.: AR0005-3

FERRAMENTA PARA APLICAÇÃO DE ILHÓS

CÓDIGO DE BARRA: 7908221655272

NCM: 82032010 IPI: 5,20%

FRAÇÃO UNIDADE

R\$ 10,00

PREÇO UNIDADE



REF.: AR0005-4

FERRAMENTA PARA FURAR TECIDOS

CÓDIGO DE BARRA: 7908221655289

NCM: 82032010 IPI: 5,20%

FRAÇÃO UNIDADE

ESGOTADO

PREÇO UNIDADE



REF.: AR0005-2

FERRAMENTA PARA APLICAÇÃO DE ILHÓS

CÓDIGO DE BARRA: 7908221649691

NCM: 8203.20.10 IPI: 5,2%

CX MASTER 120 UNID FRAÇÃO 12 UNID

R\$ 10,90

PREÇO UNIDADE

R\$ 12,50

PREÇO UNIDADE



REF.: AR0005-1

FERRAMENTA PARA APLICAÇÃO DE ILHÓS

CÓDIGO DE BARRA: 7908221649684

NCM: 8203.20.10 IPI: 5,2%

CX MASTER 120 UNID FRAÇÃO 12 UNID

R\$ 9,50

PREÇO UNIDADE

R\$ 10,50

PREÇO UNIDADE



REF.: AR0101-2

ALICATE DE APLICAÇÃO DE BOTÃO MOD.2

CÓDIGO DE BARRA: 7908221672712

NCM: 8203.20.10 IPI: 5,20%

FRAÇÃO UNIDADE

R\$ 26,65

PREÇO UNITÁRIO



REF.: AR0101-1

ALICATE DE APLICAÇÃO DE BOTÃO MOD.1

CÓDIGO DE BARRA: 7908221672705

NCM: 8203.20.10 IPI: 5,20%

FRAÇÃO UNIDADE

R\$ 26,65

PREÇO UNITÁRIO



CORTE E COSTURA

MINI ESTILETE

CARTELA COM 12 UNIDADES

NCM: 8211.93.90 IPI: 7,80%

R\$ 17,00

PREÇO CARTELA



REF.: AR6001-1

CÓDIGO DE BARRA: 7908221683497



REF.: AR6001-4

CÓDIGO DE BARRA: 7908221683527

MINI ESTILETE

CARTELA COM 12 UNIDADES

NCM: 8211.93.90 IPI: 7,80%

R\$ 15,30

PREÇO CARTELA



REF.: AR6001-2

CÓDIGO DE BARRA: 7908221683503



REF.: AR6001-3

CÓDIGO DE BARRA: 7908221683510



REF.: AR6001-5

CÓDIGO DE BARRA: 7908221683534

CANETA E GIZ DE COSTURA



REF: AR0142-Q

GIZ "PANDA" DE COSTURA - BRANCO

CÓDIGO DE BARRA: 7908221683473

NCM: 9609.90.00 IPI: 0%

CX MASTER 50 CAIXAS **FRAÇÃO CAIXA C/ 50 UND**

R\$ 14,45

PREÇO CAIXA

R\$ 15,90

PREÇO CAIXA



REF: AR0142-C

GIZ DE TECIDO EM PÓ COM PONTA DE METAL

CÓDIGO DE BARRA: 7908221683466

NCM: 9609.90.00 IPI: 0%

CX MASTER 504 UND **FRAÇÃO 12 UND**

R\$ 7,35

PREÇO UNITÁRIO

R\$ 8,10

PREÇO UNITÁRIO



REF: AR0142

GIZ COSTURA - CAIXA C/ 10 UND

CÓD. DE BARRA: 7908221603099

NCM: 96099000 IPI: 0%

CX MASTER 60 CAIXAS **FRAÇÃO CAIXA C/ 10 UND**

ESGOTADO

PREÇO CAIXA

ESGOTADO

PREÇO CAIXA



PACOTE C/ 12 UNID - APROX. 17,5 CM

REF: AR0142-L

LÁPIS GIZ DE COSTURA COLORIDO

CÓD. DE BARRA: 7908221618635

NCM: 96099000 IPI: 0%

CX MASTER 144 PCT **FRAÇÃO PACOTE**

R\$ 15,45

PREÇO PACOTE

R\$ 17,00

PREÇO PACOTE



REF: UT0024-1

CANETA TIPO FANTASMINHA PRETA

CÓDIGO DE BARRA: 7908221658044

NCM: 9505.10.00 IPI: 13%

CX MASTER 1728 UNID **FRAÇÃO 12 UNID**

ESGOTADO

PREÇO UNITÁRIO

ESGOTADO

PREÇO UNITÁRIO



REF: UT0024-3

CANETA TIPO FANTASMINHA VERMELHO

CÓDIGO DE BARRA: 7908221658068

NCM: 9505.10.00 IPI: 13%

CX MASTER 1728 UNID **FRAÇÃO 12 UNID**

ESGOTADO

PREÇO UNITÁRIO

ESGOTADO

PREÇO UNITÁRIO

FITAS MÉTRICAS



REF.: AR0136

FITA METRICA 1,5 m - 1,8 cm largura
CÓD.DE BARRA: 7908221613746
NCM: 90178010 IPI: 9,75%

CX MASTER 1440 UNID FRAÇÃO 12 UNID

R\$ 0,70

PREÇO UNID

R\$ 0,80

PREÇO UNID



REF.: AR0137

FITA METRICA 1,5 m x 1,3 cm largura
CÓD.DE BARRA: 7908221630903
NCM: 90178010 IPI: 9,75%

CX MASTER 1440 UNID FRAÇÃO 12 UNID

R\$ 0,40

PREÇO UNID

R\$ 0,45

PREÇO UNID



REF.: AR2024-21

FITA METRICA 1,5 m - 1,8 cm largura
CÓD.DE BARRA: 7908221654862
NCM: 90178010 IPI: 9,75%

CXMASTER 1440 UNID FRAÇÃO 12 UNID

R\$ 0,50

PREÇO UNID

R\$ 0,55

PREÇO UNID



REF.: AR2024-19

FITA MÉTRICA VAI E VOLTA 1,5 m x 0,75 cm
CÓD.DE BARRA: 7908221654848
NCM: 90178010 IPI: 9,75%

CXMASTER 600 UNID FRAÇÃO 12 UNID

R\$ 1,45

PREÇO UNIDADE

R\$ 1,60

PREÇO UNIDADE



REF.: AR0015

FITA MÉTRICA POTINHO 1,5 m x 1,8 cm
CÓD.DE BARRA: 7908221609282
NCM: 90178010 IPI: 9,75%

CX MASTER 720 UNID FRAÇÃO 12 UNID

R\$ 1,10

PREÇO UNIDADE

R\$ 1,25

PREÇO UNIDADE



REF.: AR2024-20

FITA MÉTRICA 1,5M
CÓDIGO DE BARRA: 7908221654855
NCM: 90178010 IPI: 9,75%

CX MASTER 400 UNID FRAÇÃO UNID

R\$ 3,45

PREÇO UNIDADE

R\$ 3,80

PREÇO UNIDADE

COLCHETES

COLCHETE DE GANCHO

CARTELA COM 24 UNIDADES

NCM: 8308.10.00 IPI: 0%

Nº0 - 10 mm

Nº0

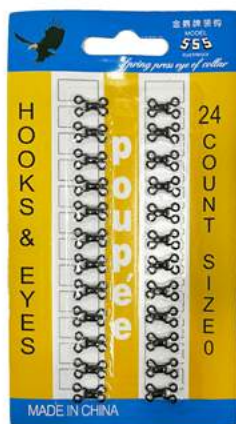

REF.: AR8000-S

PRATA

CÓDIGO DE BARRA: 7908221677458

REF.: AR8000-B

PRETO

CÓDIGO DE BARRA: 7908221677465

FRAÇÃO CAIXA C/ 36 CARTELAS

R\$ 1,85

PREÇO CARTELA



Nº1 - 12 mm

Nº1



REF.: AR8000-1-S

PRATA

CÓDIGO DE BARRA: 7908221677472

REF.: AR8000-1-B

PRETO

CÓDIGO DE BARRA: 7908221677489

FRAÇÃO CAIXA C/ 36 CARTELAS

R\$ 1,85

PREÇO CARTELA



Nº2 - 13 mm

Nº2



REF.: AR8000-2-S

PRATA

CÓDIGO DE BARRA: 7908221677496

REF.: AR8000-2-B

PRETO

CÓDIGO DE BARRA: 7908221677502

FRAÇÃO CAIXA C/ 36 CARTELAS

R\$ 2,00

PREÇO CARTELA



COLCHETES

N°3 - 15 mm

N°3

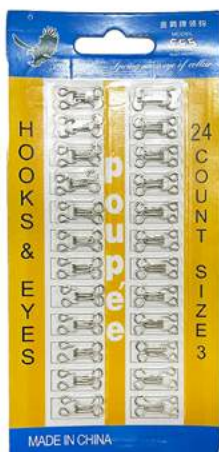
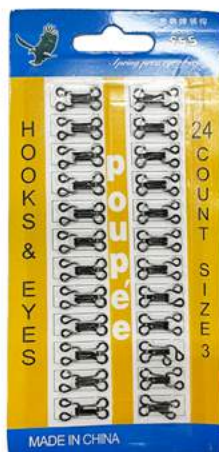

REF.: AR8000-3-S

PRATA

CÓDIGO DE BARRA: 7908221677519

REF.: AR8000-3-B

PRETO

CÓDIGO DE BARRA: 7908221677526

FRAÇÃO CAIXA C/ 36 CARTELAS

R\$ 2,15

PREÇO CARTELA



N°4 - 20 mm

N°4

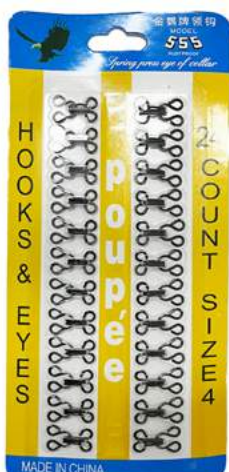
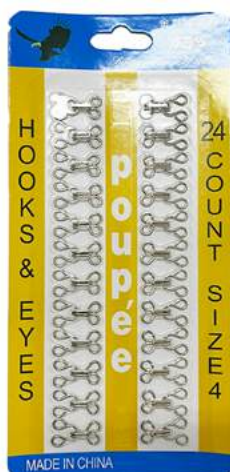

REF.: AR8000-4-S

PRATA

CÓDIGO DE BARRA: 7908221677533

REF.: AR8000-4-B

PRETO

CÓDIGO DE BARRA: 7908221677540

FRAÇÃO CAIXA C/ 36 CARTELAS

R\$ 4,00

PREÇO CARTELA



COLCHETES

COLCHETE DE PRESSÃO

NCM: 8308.10.00 IPI: 0%

Nº0 - 8,5 mm - 36 PARES / CARTELA

Nº0 - 8,5 mm

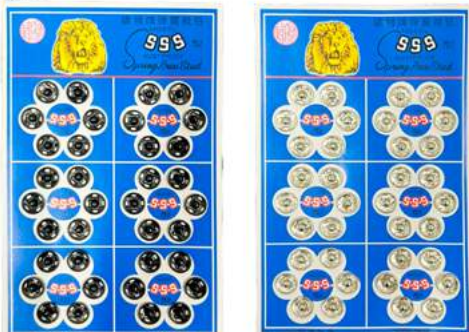

REF.: AR8001-S

PRATA

CÓDIGO DE BARRA: 7908221677557

REF.: AR80001-B

PRETO

CÓDIGO DE BARRA: 7908221677564

FRAÇÃO CAIXA COM 8 CARTELAS

R\$ 1,90

PREÇO CARTELA

Nº1 - 10 mm - 36 PARES / CARTELA

Nº1 - 10 mm

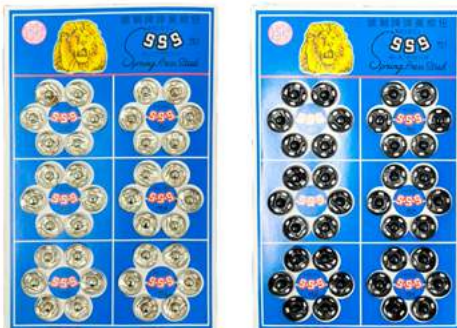

REF.: AR8001-1-S

PRATA

CÓDIGO DE BARRA: 7908221677571

REF.: AR8001-1-B

PRETO

CÓDIGO DE BARRA: 7908221677588

FRAÇÃO CAIXA COM 8 CARTELAS

R\$ 2,05

PREÇO CARTELA

Nº2 - 12 mm - 20 PARES / CARTELA

Nº2 - 12 mm



REF.: AR8001-2-S

PRATA

CÓDIGO DE BARRA: 7908221677595

REF.: AR8001-2-B

PRETO

CÓDIGO DE BARRA: 7908221677601

FRAÇÃO CAIXA COM 8 CARTELAS

R\$ 1,80

PREÇO CARTELA

Nº3 - 14 mm - 20 PARES / CARTELA

Nº3 - 14 mm



REF.: AR8001-3-S

PRATA

CÓDIGO DE BARRA: 7908221677618

REF.: AR8001-3-B

PRETO

CÓDIGO DE BARRA: 7908221677625

FRAÇÃO CAIXA COM 7 CARTELAS

R\$ 2,40

PREÇO CARTELA



TESOURAS

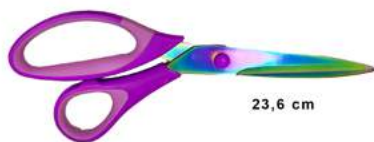

23,6 cm

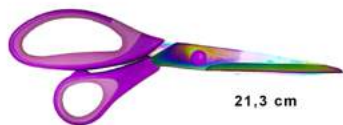

21,3 cm



14,3 cm



AR0180-1 KIT TESOURA DE TITÂNIO

3 TAMANHOS:

23.6 cm / 21,3 cm / 14,3 cm

CÓDIGO DE BARRA: 7908221688249

NCM: 8213.00.00 IPI: 7,80%

CX MASTER 72 KITS

FRAÇÃO KIT

R\$ 27,80

PREÇO KIT

R\$ 30,60

PREÇO KIT



AR0180-2 KIT TESOURA

2 TAMANHOS:

20 cm / 14 cm

CÓDIGO DE BARRA: 7908221688256

NCM: 8213.00.00 IPI: 7,80%

CX MASTER 240 KITS

FRAÇÃO 12 KITS

R\$ 5,85

PREÇO KIT

R\$ 6,45

PREÇO KIT



TESOURAS



REF.: AR0166-T

TESOURA 7"

CÓD.DE BARRA: 7908221618666

NCM: 82130000 IPI: 7,80%

CXMASTER 600 UNID FRAÇÃO 12 UNID

ESGOTADO

PREÇO UNID

ESGOTADO

PREÇO UNID



REF.: AR0165-T

TESOURA 8.5"

CÓD.DE BARRA: 7908221618659

NCM: 82130000 IPI: 7,80%

CXMASTER 360 UNID FRAÇÃO 12 UNID

ESGOTADO

PREÇO UNID

ESGOTADO

PREÇO UNID



REF.: AR0164-T

TESOURA 9.5"

CÓD.DE BARRA: 7908221654022

NCM: 82130000 IPI: 7,80%

CX MASTER 360 UNID FRAÇÃO 12 UNID

R\$ 3,10

PREÇO UNID

R\$ 3,45

PREÇO UNID



REF.: AR0163-T

TESOURA 10.5"

CÓD.DE BARRA: 7908221654039

NCM: 82130000 IPI: 7,80%

CX MASTER 240 UNID FRAÇÃO 10 UNID

R\$ 4,30

PREÇO UNID

R\$ 4,75

PREÇO UNID



REF.: AR2024-8

TESOURA 13CM

CÓD. DE BARRA: 7908221654206

NCM: 82130000 IPI: 7,80%

CX MASTER 240 UNID FRAÇÃO 12 UNID

R\$ 11,00

PREÇO UNID

R\$ 12,50

PREÇO UNID



REF.: AR2024-9

TESOURA 12.8CM

CÓD.DE BARRA: 7908221654213

NCM: 82130000 IPI: 7,80%

CXMASTER 488 UNID FRAÇÃO 12 UNID

R\$ 11,00

PREÇO UNID

R\$ 12,50

PREÇO UNID



REF.: AR2024-4

TESOURA DE METAL 8,8 CM

CÓD. DE BARRA: 7908221654138

NCM: 82130000 IPI: 7,80%

CX MASTER 1200 UNID FRAÇÃO 24 UNID

R\$ 2,45

PREÇO UNID

R\$ 2,70

PREÇO UNID



REF.: AR2024-10

TESOURA 10CM

CÓD.DE BARRA: 7908221654220

NCM: 82130000 IPI: 7,80%

CX MASTER 1200 UNID FRAÇÃO 12 UNID

R\$ 1,45

PREÇO UNID

R\$ 1,60

PREÇO UNID



REF.: AR0672

TESOURA GARÇA METAL - 8,9 CM

CÓD.DE BARRA: 7908221614392

NCM: 82119390 IPI: 7,80%

CX MASTER 720 UNID FRAÇÃO 12 UNID

R\$ 11,80

PREÇO UNID

R\$ 13,00

PREÇO UNID



REF.: AR-K-8007

TESOURA 7.5" - APROX. 18,7CM

CÓD. DE BARRA: 7908221654176

NCM: 82130000 IPI: 7,80%

CX MASTER 360 UNID FRAÇÃO 12 UNID

R\$ 4,50

PREÇO UNID

R\$ 4,95

PREÇO UNID



REF.: AR0672-1

TESOURA 9,5 cm

CÓD. DE BARRA: 7908221668159

NCM: 8213.00.00 IPI: 7,80%

CX MASTER 600 UNID FRAÇÃO 12 UNID

R\$ 17,05

PREÇO UNID

R\$ 18,80

PREÇO UNID



TESOURAS



REF.: AR0022-6

TESOURA METAL 6' - 15,25 CM
CÓD. DE BARRA: 7908221618697
NCM: 82130000 IPI: 17,80%

CX MASTER 360 UND FRAÇÃO 12 UND

R\$ 14,50
PREÇO UNID

R\$ 16,00
PREÇO UNID



REF.: AR0022-7

TESOURA METAL 7' - 17,5CM
CÓD. DE BARRA: 7908221614378
NCM: 82130000 IPI: 7,80%

CX MASTER 240 UND FRAÇÃO 12 UND

R\$ 17,70
PREÇO UNID

R\$ 19,50
PREÇO UNID



REF.: AR0022-8

TESOURA METAL 8' - 20CM
CÓD. DE BARRA: 7908221614385
NCM: 82130000 IPI: 7,80%

CX MASTER 240 UND FRAÇÃO 12 UND

R\$ 19,70
PREÇO UNID

R\$ 22,00
PREÇO UNID



REF.: AR-K-8006

TESOURA DE METAL 7" - APROX. 17,60 cm
CÓDIGO DE BARRA: 7908221654183
NCM: 82130000 IPI: 7,80%

CX MASTER 600 UND FRAÇÃO 12 UND

R\$ 4,25
PREÇO UNIDADE

R\$ 4,70
PREÇO UNIDADE



REF.: AR-K-8008

TESOURA DE METAL 8.5" - APROX. 21,60 cm
CÓDIGO DE BARRA: 7908221654169
NCM: 82130000 IPI: 7,80%

CX MASTER 240 UND FRAÇÃO 12 UND

R\$ 5,50
PREÇO UNIDADE

R\$ 6,05
PREÇO UNIDADE



REF.: AR-K-8009

TESOURA DE METAL 9.5" - APROX. 24 cm
CÓDIGO DE BARRA: 7908221654152
NCM: 82130000 IPI: 7,80%

CX MASTER 240 UND FRAÇÃO 12 UND

R\$ 6,00
PREÇO UNIDADE

R\$ 6,60
PREÇO UNIDADE



REF.: AR1212

TESOURA METAL 24CM
CÓD. DE BARRA: 7908221613623
NCM: 82130000 IPI: 7,80%

CX MASTER 96 UND FRAÇÃO 12 UND

R\$ 21,00
PREÇO UNID

R\$ 23,00
PREÇO UNID



REF.: AR2024-6

TESOURA METAL 24.5CM
CÓD. DE BARRA: 7908221654190
NCM: 82130000 IPI: 7,80%

CX MASTER 144 UND FRAÇÃO 12 UND

R\$ 21,00
PREÇO UNID

R\$ 23,00
PREÇO UNID



REF.: AR0022-P

TESOURA PICOTAR 9" APROX. 23CM
CÓD. DE BARRA: 7908221613630
NCM: 82130000 IPI: 7,80%

CX MASTER 120 UNID FRAÇÃO UNID

R\$ 29,80
PREÇO UNIDADE

R\$ 32,80
PREÇO UNID

RÉGUAS

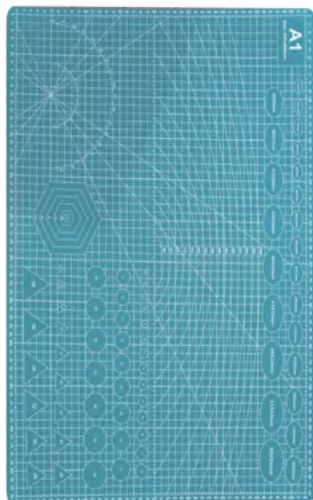

REF.: AR0800-1

RÉGUA DE PATCHWORK 90 x 60 cm
CÓD.DE BARRA: 7908221672521
NCM: 9017.20.00 IPI: 9,75%

FRAÇÃO UNIDADE

R\$ 63,90
PREÇO UNITÁRIO

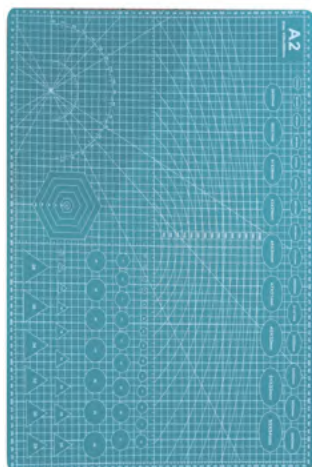

REF.: AR0800-2

RÉGUA DE PATCHWORK 45 x 60 cm
CÓD. DE BARRA: 7908221672538
NCM: 9017.20.00 IPI: 9,75%

FRAÇÃO UNIDADE

R\$ 31,95
PREÇO UNITÁRIO

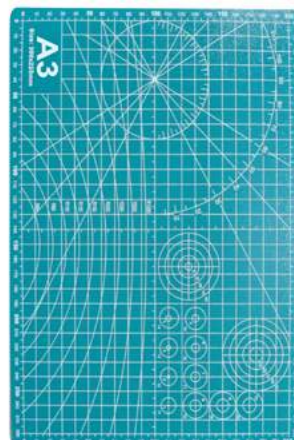

REF.: AR0800-3

RÉGUA DE PATCHWORK 30 x 45 cm
CÓDIGO DE BARRA: 7908221672545
NCM: 9017.20.00 IPI: 9,75%

FRAÇÃO UNIDADE

R\$ 16,00
PREÇO UNITÁRIO

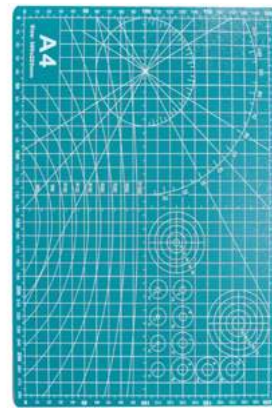

REF.: AR0800-4

RÉGUA DE PATCHWORK - 22 x 30 cm
CÓDIGO DE BARRA: 7908221672552
NCM: 9017.20.00 IPI: 9,75%

FRAÇÃO UNIDADE

R\$ 8,00
PREÇO UNITÁRIO



100 cm

REF.:AR0010-P

RÉGUA DE PLÁSTICO - 100 cm X 0,5 cm
CÓDIGO DE BARRA: 7908221684517
NCM: 9017.20.00 IPI: 9,75%

CX MASTER 300 UND FRAÇÃO UNIDADE

R\$ 3,15
PREÇO UNITÁRIO

R\$ 3,50
PREÇO UNITÁRIO

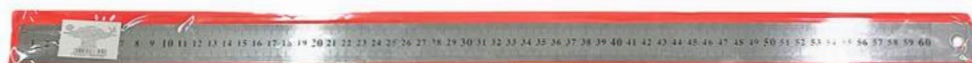

60 cm

REF.:AR0010-M

RÉGUA DE METAL - 60 cm X 0,5 cm
CÓDIGO DE BARRA: 7908221683442
NCM: 7319.90.00 IPI: 9,75%

CX MASTER 300 UND FRAÇÃO 12 UND

R\$ 3,40
PREÇO UNITÁRIO

R\$ 3,75
PREÇO UNITÁRIO



100 cm

REF.:AR0010-M2

RÉGUA DE METAL - 100 cm X 0,5 cm
CÓDIGO DE BARRA: 7908221683459
NCM: 7319.90.00 IPI: 9,75%

CX MASTER 300 UND FRAÇÃO 12 UND

R\$ 8,35
PREÇO UNITÁRIO

R\$ 9,20
PREÇO UNITÁRIO

RÉGUAS

RÉGUAS PARA COSTURA

NCM: 9017.20.00 IPI: 9,75%

FRAÇÃO

R\$ 6,90
PREÇO UNITÁRIO

45 cm X 15 cm



REF.: AR0010-1

MOD. ALFAIATE ESQUADRO

CÓDIGO DE BARRA: 7908221684586

30 cm X 10,5 cm

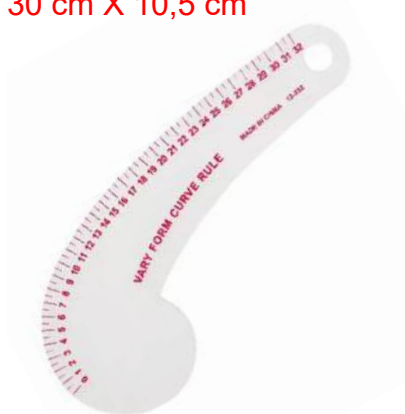

REF.: AR0010-2

MOD. CAVA DE CAMISA

CÓDIGO DE BARRA: 7908221684593

20,5 cm X 13 cm



REF.: AR0010-5

MOD. MODELISTA CURVA

CÓDIGO DE BARRA: 7908221684623

52 cm X 12,5 cm



REF.: AR0010-6

MOD. MODELISTA CURVA

CÓDIGO DE BARRA: 7908221684630

20,5 cm X 13,5 cm



REF.: AR0010-7

MOD. MODELISTA CURVA

CÓDIGO DE BARRA: 7908221684647

47 cm X 15 cm



REF.: AR0010-8

MOD. FRANCESA TRIANGULAR

CÓDIGO DE BARRA: 7908221684654

46 cm X 8 cm



REF.: AR0010-9

MOD. MODELISTA CURVA

CÓDIGO DE BARRA: 7908221684661

58 cm X 10 cm



REF.: AR0010-11

MOD. MODELISTA CURVA

CÓDIGO DE BARRA: 7908221684685

RÉGUAS

RÉGUAS PARA COSTURA

NCM: 9017.20.00 IPI: 9,75%

FRAÇÃO

R\$ 4,90

PREÇO UNITÁRIO

30 cm X 11 cm



REF.: AR0010-3

MOD. CURVA FRANCESA

CÓDIGO DE BARRA: 7908221684609

RÉGUAS PARA COSTURA

NCM: 9017.20.00 IPI: 9,75%

FRAÇÃO

R\$ 4,50

PREÇO UNITÁRIO

55 cm X 5 cm



REF.: AR0010-10

MOD. MODELISTA (A)

CÓDIGO DE BARRA: 7908221684678

55 cm X 5 cm



REF.: AR0010-13

MOD. MODELISTA (C)

CÓDIGO DE BARRA: 7908221684708

45 cm X 5 cm

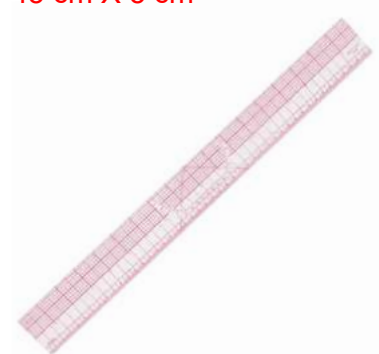

REF.: AR0010-15

MOD. ALFAIATE

CÓDIGO DE BARRA: 7908221684722

RÉGUAS PARA COSTURA

NCM: 9017.20.00 IPI: 9,75%

FRAÇÃO

R\$ 8,90

PREÇO UNITÁRIO

29 cm X 13 cm



REF.: AR0010-14

MOD. CURVA FRANCESA

CÓDIGO DE BARRA: 7908221684715

RÉGUAS

RÉGUAS PARA COSTURA

NCM: 9017.20.00 IPI: 9,75%

55 cm X 5 cm



REF.: AR0010-12

MOD. MODELISTA (B)

CÓDIGO DE BARRA: 7908221684692

FRAÇÃO

R\$ 4,00

PREÇO UNITÁRIO

RÉGUAS PARA COSTURA

NCM: 9017.20.00 IPI: 9,75%

25,5 cm X 4 cm

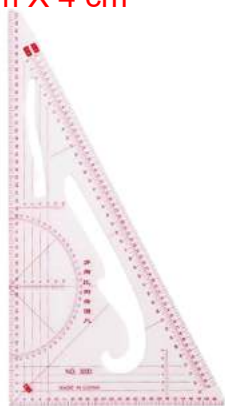

REF.: AR0010-4

MOD. FRANCESA TRIANGULAR

CÓDIGO DE BARRA: 7908221684616

FRAÇÃO

R\$ 3,90

PREÇO UNITÁRIO

PRENDEDORES DE PATCHWORK

PRENDEDOR DE PATCHWORK

PACOTE COM 50 UNIDADES

NCM: 3926.90.90 IPI: 9,75%



2,7 cm
PACOTE COM 50 UNIDADES

REF.: AR0800-P1

2,7 cm - PACOTE COM 50 UNIDADES

CÓDIGO DE BARRA: 7908221684555

CX MASTER 200 PCT

FRAÇÃO PACOTE

R\$ 9,10

PREÇO PACOTE

R\$ 10,05

PREÇO PACOTE



5,5 cm
PACOTE COM 50 UNIDADES

REF.: AR0800-P2

5,5 cm - PACOTE COM 50 UNIDADES

CÓDIGO DE BARRA: 7908221684562

CX MASTER 100 PCT

FRAÇÃO PACOTE

R\$ 26,95

PREÇO PACOTE

R\$ 29,65

PREÇO PACOTE

KIT TEAR

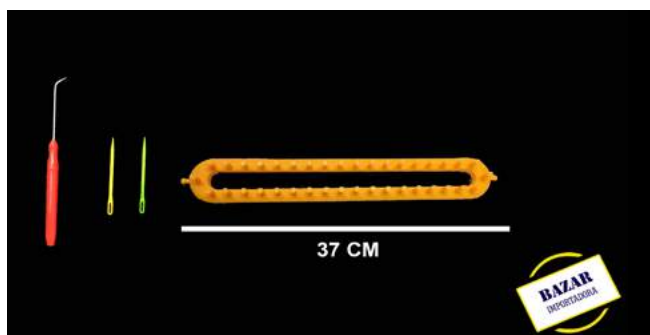

REF.: AR0021-2

KIT TEAR 4 PEÇAS - APROX. 37 CM

CÓDIGO DE BARRA: 7908221615184

NCM: 7319.90.00 IPI: 9,75%

CX MASTER 100 KITS **FRAÇÃO** KIT

R\$ 16,20

PREÇO KIT

R\$ 17,85

PREÇO KIT

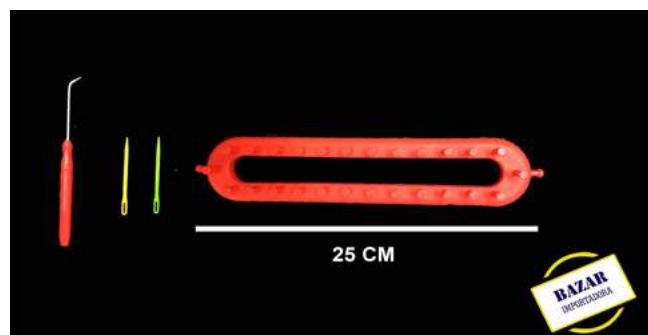

REF.: AR0021-1

KIT TEAR 4 PEÇAS - APROX. 25 CM

CÓDIGO DE BARRA: 7908221615177

NCM: 7319.90.00 IPI: 9,75%

KIT COM 4 PEÇAS

CX MASTER 100 KITS **FRAÇÃO** KIT

R\$ 13,50

PREÇO KIT

R\$ 14,85

PREÇO KIT

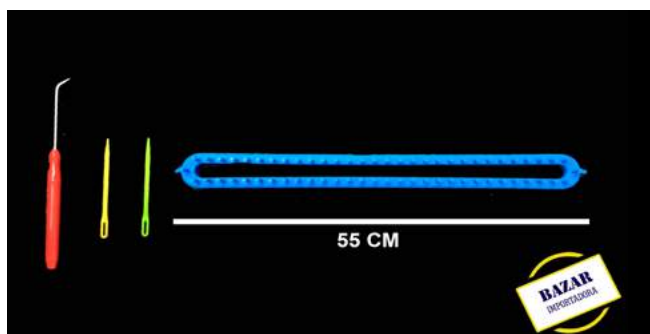

REF.: AR0021-4

KIT TEAR 4 PEÇAS - APROX. 55 CM

CÓDIGO DE BARRA: 7908221615207

NCM: 7319.90.00 IPI: 9,75%

CX MASTER 80 KITS **FRAÇÃO** KIT

R\$ 20,25

PREÇO KIT

R\$ 22,30

PREÇO KIT

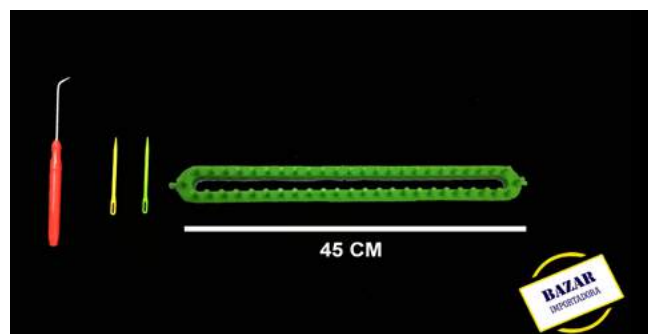

REF.: AR0021-3

KIT TEAR 4 PEÇAS - APROX. 45 CM

CÓDIGO DE BARRA: 7908221615191

NCM: 7319.90.00 IPI: 9,75%

CX MASTER 100 KITS **FRAÇÃO** KIT

R\$ 18,90

PREÇO KIT

R\$ 20,80

PREÇO KIT

COLA PARA ARTESANATO



1.1mm x 27cm
GROSSA

REF: UT1200-1

BASTÃO DE COLA GROSSA PARA ARTESANATO - 500g

MOD.1 - 1,1mm X 27cm

CÓDIGO DE BARRA: 7908221623738

NCM: 3506.91.20 IPI: 0%

PROMOÇÃO!

PREÇO

PACOTE C/ 500g - R\$ 11,95

PREÇO DO KG (2 PCT DE 500g) - R\$ 23,90

FIOS E CORDÕES



REF.: AR0060-1

CORDÃO MINI FOLHAS - 3 M
CÓDIGO DE BARRA: 7908221649677
NCM: 5306.20.00 IPI: 0%

FRAÇÃO PACOTE C/ 24 UNID

R\$ 76,50

PREÇO PACOTE



CORDÃO POSSUI 7 MM X 10 M



REF.: AR0060

CORDÃO MINI FOLHAS - 7MM*10M
CÓDIGO DE BARRA: 7908221648953
NCM: 5306.20.00 IPI: 0%

CX MASTER 350 UNID

FRAÇÃO 12 UNID

R\$ 10,20

PREÇO UNIDADE

R\$ 11,20

PREÇO UNIDADE



REF.: AR0060-2

CORDÃO DE PAPEL MINI FOLHA - 2 M
CÓDIGO DE BARRA: 7908221649639
NCM: 5306.20.00 IPI: 0%

CX MASTER 360 UNID

FRAÇÃO 12 UND MIX

R\$ 3,00

PREÇO UNIDADE

R\$ 3,30

PREÇO UNIDADE



REF.: AR0060-3

CORDÃO DE PAPEL MINI FOLHA - 2 M
CÓDIGO DE BARRA: 7908221649646
NCM: 5306.20.00 IPI: 0%

CX MASTER 360 UNID

FRAÇÃO 12 UND MIX

R\$ 3,20

PREÇO UNIDADE

R\$ 3,60

PREÇO UNIDADE



REF.: AR1615-3

FIO DE LINHO 3MM - APROX. 50 JARDAS
CÓDIGO DE BARRA: 7908221648946
NCM: 53062000 IPI: 13%

CX MASTER 192 UNID

FRAÇÃO 12 UNID

ESGOTADO

PREÇO UNIDADE

ESGOTADO

PREÇO UNIDADE



REF.: AR1615-2

FIO DE LINHO 2MM - APROX. 100 JARDAS
CÓDIGO DE BARRA: 7908221648939
NCM: 53062000 IPI: 13%

CX MASTER 240 UNID

FRAÇÃO 12 UNID

ESGOTADO

PREÇO UNIDADE

ESGOTADO

PREÇO UNIDADE



FIOS E CORDÕES



REF: AR0060-4

CORDÃO MINI FOLHA 5 mm - 100 m a unidade

CÓDIGO DE BARRA: 7908221667602

NCM: 5306.20.00 IPI: 0%

FRAÇÃO UNIDADE

R\$ 83,00

PREÇO UNIDADE



REF: AR0060-5

CORDÃO MINI FOLHA DOURADO 5 mm - 200 m

CÓDIGO DE BARRA: 7908221667619

NCM: 53062000 IPI: 0%

FRAÇÃO UNIDADE

R\$ 110,00

PREÇO UNIDADE



REF: AR0060-6

CORDÃO MINI FOLHA VERDE 5 mm - 200 m

CÓDIGO DE BARRA: 7908221667626

NCM: 53062000 IPI: 0%

FRAÇÃO UNIDADE

R\$ 59,50

PREÇO UNIDADE

FIOS E CORDÕES



REF.: AR0400-1

CORDÃO DOURADO PARA ARTESANATO - 0.5 mm - 100 m

CÓDIGO DE BARRA: 7908221669712

NCM: 56049090 IPI: 0%

CX MASTER 200 UNID FRAÇÃO UNIDADE

R\$ 5,75

PREÇO UNIDADE

R\$ 6,35

PREÇO UNIDADE



REF.: AR0400-2

CORDÃO PRATA PARA ARTESANATO - 0.5 mm - 100 m

CÓDIGO DE BARRA: 7908221669729

NCM: 56049090 IPI: 0%

CX MASTER 200 UNID FRAÇÃO UNIDADE

R\$ 5,75

PREÇO UNIDADE

R\$ 6,35

PREÇO UNIDADE

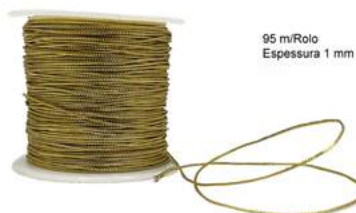

REF.: AR0401-1

CORDÃO DOURADO PARA ARTESANATO - 1 mm - 95 m

CÓDIGO DE BARRA: 7908221669736

NCM: 56049090 IPI: 0%

CX MASTER 200 UNID FRAÇÃO UNIDADE

R\$ 6,65

PREÇO UNIDADE

R\$ 7,35

PREÇO UNIDADE



REF.: AR0401-2

CORDÃO PRATA PARA ARTESANATO - 1 mm - 100 m

CÓDIGO DE BARRA: 7908221669743

NCM: 56049090 IPI: 0%

CX MASTER 200 UNID FRAÇÃO UNIDADE

R\$ 6,65

PREÇO UNIDADE

R\$ 7,35

PREÇO UNIDADE



REF.: AR0402-1

CORDÃO DOURADO PARA ARTESANATO - 1.5 mm - 45 m

CÓDIGO DE BARRA: 7908221669750

NCM: 56049090 IPI: 0%

CX MASTER 200 UNID FRAÇÃO UNIDADE

R\$ 4,85

PREÇO UNIDADE

R\$ 5,35

PREÇO UNIDADE



REF.: AR0402-2

CORDÃO PRATA PARA ARTESANATO - 1.5 mm - 45 m

CÓDIGO DE BARRA: 7908221669767

NCM: 56049090 IPI: 0%

CX MASTER 200 UNID FRAÇÃO UNIDADE

R\$ 4,85

PREÇO UNIDADE

R\$ 5,35

PREÇO UNIDADE



FIOS E CORDÕES



REF: AR0403-1

CORDÃO DOURADO PARA ARTESANATO - 2 mm - 45 m

CÓDIGO DE BARRA: 7908221669774

NCM: 95059000 IPI: 13%

CX MASTER 200 UNID **FRAÇÃO UNIDADE**

R\$ 6,05

PREÇO UNIDADE

R\$ 6,70

PREÇO UNIDADE



REF: AR0403-2

CORDÃO PRATA PARA ARTESANATO - 2 mm - 45 m

CÓDIGO DE BARRA: 7908221669781

NCM: 95059000 IPI: 13%

CX MASTER 200 UNID **FRAÇÃO UNIDADE**

R\$ 6,05

PREÇO UNIDADE

R\$ 6,70

PREÇO UNIDADE



REF: AR0404-1

CORDÃO DOURADO PARA ARTESANATO - 2.5 mm - 45 m

CÓDIGO DE BARRA: 7908221669798

NCM: 95059000 IPI: 13%

CX MASTER 100 UNID **FRAÇÃO UNIDADE**

R\$ 7,00

PREÇO UNIDADE

R\$ 7,70

PREÇO UNIDADE



REF: AR0404-2

CORDÃO PRATA PARA ARTESANATO - 2.5 mm - 45 m

CÓDIGO DE BARRA: 7908221669804

NCM: 95059000 IPI: 13%

CX MASTER 100 UNID **FRAÇÃO UNIDADE**

R\$ 7,00

PREÇO UNIDADE

R\$ 7,70

PREÇO UNIDADE

FIOS E CORDÕES



3000 jardas



REF.: AR2024-204

CONE DE LINHA DE COSTURA PRATA - 150D - 3000J

CÓDIGO DE BARRA: 7908221657184

NCM: 54011012 IPI: 0%

FRAÇÃO UNIDADE

R\$ 9,60

PREÇO UNIDADE



3000 jardas



REF.: AR2024-203

CONE DE LINHA DE COSTURA DOURADA - 150D - 3000J

CÓDIGO DE BARRA: 7908221657177

NCM: 54011012 IPI: 0%

FRAÇÃO UNIDADE

R\$ 9,60

PREÇO UNIDADE



REF.:AR1616-MIL

LINHA PARA COSTURA 100% POLIPÉSTER
1000m - 1X12

CÓDIGO DE BARRA: 7908221637278

NCM: 5401.10.12 IPI: 0%

FRAÇÃO PCT C/12 UNID.

R\$ 38,00

PREÇO PACOTE



REF.: AR1616

LINHA DE COSTURA 100% POLIÉSTER BRANCA
500m - 1X12

CÓDIGO DE BARRA: 7908221614811

NCM: 5401.10.12 IPI: 0%

FRAÇÃO PCT C/12 UNID.

R\$ 19,00

PREÇO PACOTE



REF.: AR0061-1

CORDÃO COLORIDO 10 M - 3X1

CÓDIGO DE BARRA: 7908221649653

NCM: 5306.20.00 IPI: 0%

CX MASTER 240 PACOTES FRAÇÃO 12 PACOTES

R\$ 3,95

PREÇO PACOTE

R\$ 4,50

PREÇO PACOTE



PENAS

PENA MOD.1 - PENA DE GALO

TAMANHO: 28 cm

PACOTE COM 50 PENAS

NCM: 9505.90.00 IPI: 13%

FRAÇÃO 50 UND MSM COR

R\$ 0,70

PREÇO UNIDADE PENA



REF.: AR6600-GR

CÓDIGO DE BARRA: 7908221690716



REF.: AR6600-Y

CÓDIGO DE BARRA: 7908221690075



REF.: AR6600-PK

CÓDIGO DE BARRA: 7908221690099



REF.: AR6600-DB

CÓDIGO DE BARRA: 7908221690129



REF.: AR6600-RX

CÓDIGO DE BARRA: 7908221690105



REF.: AR6600-O

CÓDIGO DE BARRA: 7908221690112



REF.: AR6600-W

CÓDIGO DE BARRA: 7908221690587



REF.: AR6600-R

CÓDIGO DE BARRA: 7908221690143

PENAS

PENA MOD.2

TAMANHO: 12 cm a 14 cm

PACOTE COM 10 PENAS

NCM: 9505.90.00 IPI: 13%

CX MASTER 600 PCT

R\$ 2,10

PREÇO PACOTE

FRAÇÃO 12 PCT MSM COR

R\$ 2,40

PREÇO PACOTE



REF.: AR0026-GR

CÓDIGO DE BARRA: 7908221690136



REF.: AR0026-Y

CÓDIGO DE BARRA: 7908221690204



REF.: AR0026-PK

CÓDIGO DE BARRA: 7908221691140



ESGOTADO

CÓDIGO DE BARRA: 7908221691157

REF.: AR0026-RX

CÓDIGO DE BARRA: 7908221691164

REF.: AR0026-O

CÓDIGO DE BARRA: 7908221691171



REF.: AR0026-W

CÓDIGO DE BARRA: 7908221691188

REF.: AR0026-BL

CÓDIGO DE BARRA: 7908221691218

REF.: AR0026-R

CÓDIGO DE BARRA: 7908221691201

PENAS

PENA MOD.3 - PENA DE PATO

TAMANHO: 26 cm

PACOTE COM 6 PENAS

NCM: 9505.90.00 IPI: 13%

FRAÇÃO 12 PACOTES MSM COR

R\$ 4,90

PREÇO PACOTE



REF.:AR0056-GR

CÓDIGO DE BARRA: 7908221690211

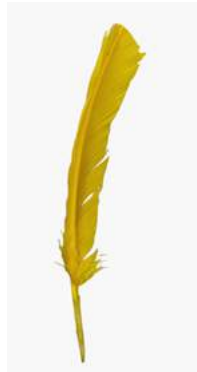

REF.:AR0056-Y

CÓDIGO DE BARRA: 7908221690242



REF.:AR0056-PK

CÓDIGO DE BARRA: 7908221690259



REF.:AR0056-DB

CÓDIGO DE BARRA: 7908221690235



REF.:AR0056-RX

CÓDIGO DE BARRA: 7908221690600



REF.:AR0056-O

CÓDIGO DE BARRA: 7908221690266



REF.:AR0056-W

CÓDIGO DE BARRA: 7908221690273



REF.:AR0056-B

CÓDIGO DE BARRA: 7908221690723



REF.:AR0056-R

CÓDIGO DE BARRA: 7908221690297

PENAS



REF: AR0056-MIX

PENA MOD. 3 MIX COR - 26 cm - PCT C/ 6 UNIDADES

CÓDIGO DE BARRA: 7908221690280

NCM: 9505.90.00 IPI: 13%

CX MASTER 240 PACOTES **FRAÇÃO 12 PACOTES**

R\$ 5,35

PREÇO PACOTE

R\$ 5,90

PREÇO PACOTE



REF: AR0026-MIX

KIT PENA MIX COR COM 12 UNIDADES - 14 cm

CÓDIGO DE BARRA: 7908221635151

NCM: 9505.90.00 IPI: 13%

CX MASTER 600 KITS

FRAÇÃO 12 KITS

R\$ 2,10

PREÇO KIT

R\$ 2,40

PREÇO KIT



REF: AR0026-3

ADEREÇO P/ ARTESANATO PENA MOD. 3 - aprox 18cm

CÓDIGO DE BARRA: 7908221635182

NCM: 9505.90.00 IPI: 13%

CX MASTER 600 KITS

FRAÇÃO 12 KITS

ESGOTADO

PREÇO KIT

ESGOTADO

PREÇO KIT



REF: AR0026-2

ADEREÇO PARA ARTESANATO TIPO PENA MOD. 2 - 18 cm

CÓDIGO DE BARRA: 7908221635175

NCM: 9505.90.00 IPI: 13%

CX MASTER 600 KITS

FRAÇÃO 12 KITS MSM MOD

ESGOTADO

PREÇO KIT

ESGOTADO

PREÇO KIT

30 cm



REF: AR0026

PENA DE PAVÃO 35 cm X 30 cm

CÓDIGO DE BARRA: 7908221602542

NCM: 9505.90.00 IPI: 13%

FRAÇÃO 10 UNIDADES

R\$ 2,90

PREÇO UNITÁRIO

FITA CETIM ROCOCÔ



REF.: GA90-24

FITA CETIM ROCOCÔ - 0,6 cm - 100 jardas

CÓDIGO DE BARRA: 7908221669873

NCM: 6307.90.90 IPI: 0%

FRAÇÃO PACOTE

R\$ 50,05

PREÇO PACOTE



REF.: GA90-12

FITA CETIM ROCOCÔ

0,6 cm - 100 jardas

CÓD. DE BARRA: 7908221669842

NCM: 6307.90.90 IPI: 0%



REF.: GA90-26

FITA CETIM ROCOCÔ

0,6 cm - 100 jardas

CÓD DE BARRA: 7908221669880

NCM: 6307.90.90 IPI: 0%



REF.: GA90-4

FITA CETIM ROCOCÔ

0,6 cm - 100 jardas

CÓD. DE BARRA: 7908221669835

NCM: 6307.90.90 IPI: 0%



REF.: GA90-259

FITA CETIM ROCOCÔ

0,6 cm - 100 jardas

CÓD DE BARRA: 7908221669934

NCM: 6307.90.90 IPI: 0%



REF.: GA90-28

FITA CETIM ROCOCÔ

0,6 cm - 100 jardas

CÓD DE BARRA: 7908221669897

NCM: 6307.90.90 IPI: 0%



REF.: GA90-39

FITA CETIM ROCOCÔ

0,6 cm - 100 jardas

CÓD DE BARRA: 7908221669903

NCM: 6307.90.90 IPI: 0%



REF.: GA90-16

FITA CETIM ROCOCÔ

0,6 cm - 100 jardas

CÓD DE BARRA: 7908221669859

NCM: 6307.90.90 IPI: 0%



REF.: GA90-1082

FITA CETIM ROCOCÔ

0,6 cm - 100 jardas

CÓD DE BARRA: 7908221669941

NCM: 6307.90.90 IPI: 0%



REF.: GA90-40

FITA CETIM ROCOCÔ

0,6 cm - 100 jardas

CÓD DE BARRA: 7908221669910

NCM: 6307.90.90 IPI: 0%



REF.: GA90-42

FITA CETIM ROCOCÔ

0,6 cm - 100 jardas

CÓD DE BARRA: 7908221669927

NCM: 6307.90.90 IPI: 0%



REF.: GA90-19

FITA CETIM ROCOCÔ

0,6 cm - 100 jardas

CÓD DE BARRA: 7908221669866

NCM: 6307.90.90 IPI: 0%



REF.: GA90-1100

FITA CETIM ROCOCÔ

0,6 cm - 100 jardas

CÓD DE BARRA: 7908221669958

NCM: 6307.90.90 IPI: 0%

CORDÃO ROLITE



REF.: AR2022-2

CORDÃO ROLITE 2 MM PARA ARTESANATO 50 M - COR: 2

CÓDIGO DE BARRA: 7908221637452

NCM: 58089000 IPI: 0%

CX MASTER 100 UND FRAÇÃO UNIDADE

R\$ 5,15

PREÇO UNIDADE

R\$ 6,50

PREÇO UNIDADE

OUTRAS CORES:



REF.: AR2022-2

CORDÃO ROLITE 2 MM X 50 M - COR: 2

CÓDIGO DE BARRA: 7908221637452

NCM: 58089000 IPI: 0%



REF.: AR2022-29

CORDÃO ROLITE 2 MM 50 M - COR: 29

CÓDIGO DE BARRA: 7908221637728

NCM: 58089000 IPI: 0%



REF.: AR2022-3

CORDÃO ROLITE 2 MM 50 M - COR: 3

CÓDIGO DE BARRA: 7908221637469

NCM: 58089000 IPI: 0%



REF.: AR2022-30

CORDÃO ROLITE 2 MM 50 M - COR: 30

CÓDIGO DE BARRA: 7908221637735

NCM: 58089000 IPI: 0%



REF.: AR2022-17

CORDÃO ROLITE 2 MM 50 M - COR: 17

CÓDIGO DE BARRA: 7908221637605

NCM: 58089000 IPI: 0%



REF.: AR2022-4

CORDÃO ROLITE 2 MM 50 M - COR: 4

CÓDIGO DE BARRA: 7908221637476

NCM: 58089000 IPI: 0%



REF.: AR2022-16

CORDÃO ROLITE 2 MM 50 M - COR: 16

CÓDIGO DE BARRA: 7908221637599

NCM: 58089000 IPI: 0%



REF.: AR2022-5

CORDÃO ROLITE 2 MM 50 M - COR: 5

CÓDIGO DE BARRA: 7908221637483

NCM: 58089000 IPI: 0%



REF.: AR2022-6

CORDÃO ROLITE 2 MM 50 M - COR: 6

CÓDIGO DE BARRA: 7908221637490

NCM: 58089000 IPI: 0%



REF.: AR2022-26

CORDÃO ROLITE 2 MM 50 M - COR: 26

CÓDIGO DE BARRA: 7908221637698

NCM: 58089000 IPI: 0%



REF.: AR2022-1

CORDÃO ROLITE 2 MM 50 M - COR: 1

CÓDIGO DE BARRA: 7908221637445

NCM: 58089000 IPI: 0%



REF.: AR2022-18

CORDÃO ROLITE 2 MM 50 M - COR: 18

CÓDIGO DE BARRA: 7908221637612

NCM: 58089000 IPI: 0%



REF.: AR2022-23

CORDÃO ROLITE 2 MM 50 M - COR: 23

CÓDIGO DE BARRA: 7908221637667

NCM: 58089000 IPI: 0%



REF.: AR2022-24

CORDÃO ROLITE 2 MM 50 M - COR: 24

CÓDIGO DE BARRA: 7908221637674

NCM: 58089000 IPI: 0%



REF.: AR2022-25

CORDÃO ROLITE 2 MM 50 M - COR: 25

CÓDIGO DE BARRA: 7908221637681

NCM: 58089000 IPI: 0%



REF.: AR2022-20

CORDÃO ROLITE 2 MM 50 M - COR: 20

CÓDIGO DE BARRA: 7908221637636

NCM: 58089000 IPI: 0%

**BAZAR
IMPORTADORA**

CORDÃO ROLITE



REF: AR2022-22
CORDÃO ROLITE 2 MM 50 M - COR: 22
CÓDIGO DE BARRA: 7908221637650
NCM: 58089000 IPI: 0%



REF: AR2022-21
CORDÃO ROLITE 2 MM 50 M - COR: 21
CÓDIGO DE BARRA: 7908221637643
NCM: 58089000 IPI: 0%



REF: AR2022-13
CORDÃO ROLITE 2 MM 50 M - COR: 13
CÓDIGO DE BARRA: 7908221637568
NCM: 58089000 IPI: 0%



REF: AR2022-12
CORDÃO ROLITE 2 MM 50 M - COR: 12
CÓDIGO DE BARRA: 7908221637551
NCM: 58089000 IPI: 0%



REF: AR2022-11
CORDÃO ROLITE 2 MM 50 M - COR: 11
CÓDIGO DE BARRA: 7908221637544
NCM: 58089000 IPI: 0%



REF: AR2022-31
CORDÃO ROLITE 2 MM 50 M - COR: 31
CÓDIGO DE BARRA: 7908221637742
NCM: 58089000 IPI: 0%



REF: AR2022-10
CORDÃO ROLITE 2 MM 50 M - COR: 10
CÓDIGO DE BARRA: 7908221637537
NCM: 58089000 IPI: 0%



REF: AR2022-27
CORDÃO ROLITE 2 MM 50 M - COR: 27
CÓDIGO DE BARRA: 7908221637704
NCM: 58089000 IPI: 0%



REF: AR2022-7
CORDÃO ROLITE 2 MM 50 M - COR: 7
CÓDIGO DE BARRA: 7908221637506
NCM: 58089000 IPI: 0%



REF: AR2022-8
CORDÃO ROLITE 2 MM 50 M - COR: 8
CÓDIGO DE BARRA: 7908221637513
NCM: 58089000 IPI: 0%



REF: AR2022-9
CORDÃO ROLITE 2 MM 50 M - COR: 9
CÓDIGO DE BARRA: 7908221637520
NCM: 58089000 IPI: 0%



REF: AR2022-28
CORDÃO ROLITE 2 MM 50 M - COR: 28
CÓDIGO DE BARRA: 7908221637711
NCM: 58089000 IPI: 0%



REF: AR2022-19
CORDÃO ROLITE 2 MM 50 M - COR: 19
CÓDIGO DE BARRA: 7908221637629
NCM: 58089000 IPI: 0%



REF: AR2022-15
CORDÃO ROLITE 2 MM 50 M - COR: 15
CÓDIGO DE BARRA: 7908221637582
NCM: 58089000 IPI: 0%



REF: AR2022-14
CORDÃO ROLITE 2 MM 50 M - COR: 14
CÓDIGO DE BARRA: 7908221637575
NCM: 58089000 IPI: 0%

FIOS TIPO CAMURÇA

FIO TIPO CAMURÇA

ROLOC COM 90 m - 100% POLIÉSTER

NCM: 5809.00.00 IPI: 0%

R\$ 30,00

PREÇO ROLO



90 m X 3 mm



REF.: AR0992-R01

CÓDIGO DE BARRA: 7908221687099



REF.: AR0992-R54

CÓDIGO DE BARRA: 7908221687051



REF.: AR0992-R87

CÓDIGO DE BARRA: 7908221687044



REF.: AR0992-R69

CÓDIGO DE BARRA: 7908221687068



REF.: AR0992-R103

CÓDIGO DE BARRA: 7908221687037



REF.: AR0992-R134

CÓDIGO DE BARRA: 7908221687075



FIOS TIPO CAMURÇA

FIO TIPO CAMURÇA

ROLOC COM 90 m - 100% POLIÉSTER

NCM: 5809.00.00 IPI: 0%

R\$ 35,00

PREÇO ROLO



90 m X 3 mm



REF.: AR0992-R09

CÓDIGO DE BARRA: 7908221687105



REF.: AR0992-R28

CÓDIGO DE BARRA: 7908221687167



REF.: AR0992-R42

CÓDIGO DE BARRA: 7908221687136



REF.: AR0992-R55

CÓDIGO DE BARRA: 7908221687204



REF.: AR0992-R56

CÓDIGO DE BARRA: 7908221687198



REF.: AR0992-R62

CÓDIGO DE BARRA: 7908221687112



FIOS TIPO CAMURÇA



REF.: AR0992-R67

CÓDIGO DE BARRA: 7908221687143



REF.: AR0992-R70

CÓDIGO DE BARRA: 7908221687174



REF.: AR0992-R91

CÓDIGO DE BARRA: 7908221687129



REF.: AR0992-R100

CÓDIGO DE BARRA: 7908221687181



REF.: AR0992-R105

CÓDIGO DE BARRA: 7908221687150

FIOS TIPO CAMURÇA

FIO TRANÇADO DE CAMURÇA

100 m - 100% POLIÉSTER

NCM: 5809.00.00 IPI: 0%



100 m X 5 mm



REF.: AR0210-1

CÓDIGO DE BARRA: 7908221686986



REF.: AR0210-2

CÓDIGO DE BARRA: 7908221686962



REF.: AR0210-3

CÓDIGO DE BARRA: 7908221686979

R\$ 120,00
PREÇO PACOTE



R\$ 130,00
PREÇO PACOTE

REF.: AR0210-4

CÓDIGO DE BARRA: 7908221686986



REF.: AR0210-5

CÓDIGO DE BARRA: 7908221686993



REF.: AR0210-6

CÓDIGO DE BARRA: 7908221687006

R\$ 140,00
PREÇO PACOTE

FIOS DE LANTEJOULA

FIO DE LANTEJOULA PAETÊ

6 mm X 100 yd

NCM: 3926.90.90 IPI: 9,75%

R\$ 21,00
PREÇO UNITÁRIO

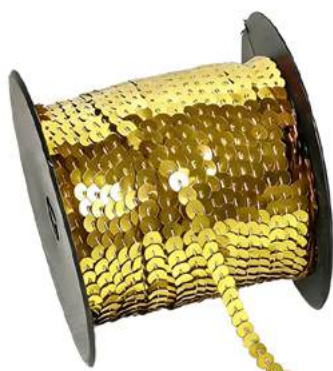

REF.: AR0410-1A

CÓDIGO DE BARRA: 7908221692710



REF.: AR0410-1

CÓDIGO DE BARRA: 7908221691997



REF.: AR0410-3

CÓDIGO DE BARRA: 7908221692024



REF.: AR0410-4

CÓDIGO DE BARRA: 7908221692086

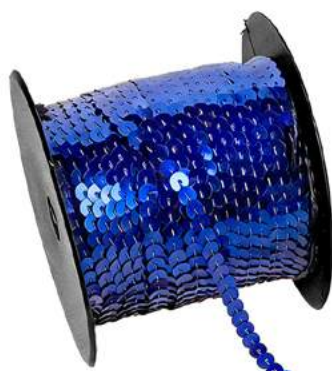

REF.: AR0410-5

CÓDIGO DE BARRA: 7908221692062



REF.: AR0410-8

CÓDIGO DE BARRA: 7908221692017



REF.: AR0410-A9

CÓDIGO DE BARRA: 7908221692109



REF.: AR0410-10

CÓDIGO DE BARRA: 7908221692116

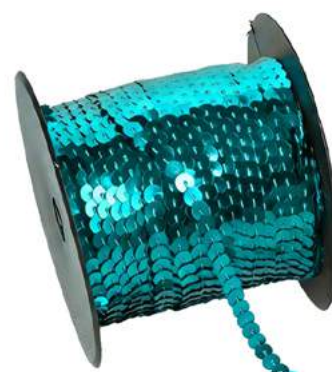

REF.: AR0410-11

CÓDIGO DE BARRA: 7908221692079



REF.: AR0410-A12

CÓDIGO DE BARRA: 7908221692031



REF.: AR0410-13

CÓDIGO DE BARRA: 7908221692055



REF.: AR0410-26A

CÓDIGO DE BARRA: 7908221692123

FIOS DE LANTEJOULA



REF.: AR0410-M45

CÓDIGO DE BARRA: 7908221692048

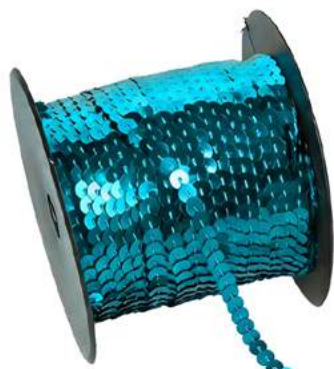

REF.: AR0410-2259

CÓDIGO DE BARRA: 7908221692093

FIOS DE LANTEJOULA

FIO DE LANTEJOULA PAETÊ HOLOGRÁFICA

6 mm X 100 yd

NCM: 3926.90.90 IPI: 9,75%

R\$ 23,00
PREÇO UNITÁRIO



REF.: AR0410-A10

CÓDIGO DE BARRA: 7908221692192



REF.: AR0410-M11

CÓDIGO DE BARRA: 7908221692130



REF.: AR0410-A20

CÓDIGO DE BARRA: 7908221692246



REF.: AR0410-A30

CÓDIGO DE BARRA: 7908221692277



REF.: AR0410-A66

CÓDIGO DE BARRA: 7908221692260



REF.: AR0410-A69

CÓDIGO DE BARRA: 7908221692178



REF.: AR0410-A70

CÓDIGO DE BARRA: 7908221692208



REF.: AR0410-A81

CÓDIGO DE BARRA: 7908221692284



REF.: AR0410-A96

CÓDIGO DE BARRA: 7908221692208



REF.: AR0410-A97

CÓDIGO DE BARRA: 7908221692253



REF.: AR0410-A109

CÓDIGO DE BARRA: 7908221692222

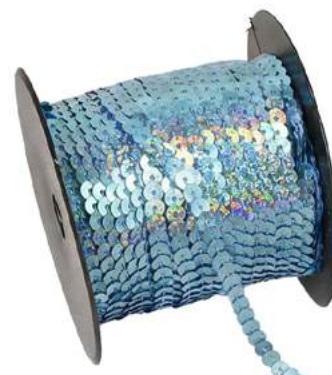

REF.: AR0410-50101

CÓDIGO DE BARRA: 7908221692314

FIOS DE LANTEJOULA



REF.: AR0410-50103

CÓDIGO DE BARRA: 7908221692147



REF.: AR0410-50108

CÓDIGO DE BARRA: 7908221692154



REF.: AR0410-50109

CÓDIGO DE BARRA: 7908221692185



ESGOTADO

CÓDIGO DE BARRA: 7908221692239



REF.: AR0410-50126

CÓDIGO DE BARRA: 7908221692291



REF.: AR0410-50129

CÓDIGO DE BARRA: 7908221692161

FIOS DE LANTEJOULA

FIO DE LANTEJOULA PAETÊ IRISADA COM COR

6 mm X 100 yd

NCM: 3926.90.90 IPI: 9,75%

R\$ 24,00

PREÇO UNITÁRIO



REF.: AR0411-22

CÓDIGO DE BARRA: 7908221692635



REF.: AR0411-24

CÓDIGO DE BARRA: 7908221692673



REF.: AR0411-93

CÓDIGO DE BARRA: 7908221692666



REF.: AR0411-96

CÓDIGO DE BARRA: 7908221692642



REF.: AR0411-A319

CÓDIGO DE BARRA: 7908221692680



REF.: AR0411-337

CÓDIGO DE BARRA: 7908221692659

FIOS DE LANTEJOULA

FIO DE LANTEJOULA PAETÊ MIX COR

6 mm X 100 yd

NCM: 3926.90.90 IPI: 9,75%

R\$ 39,90
PREÇO UNITÁRIO



REF.: AR0412-MIX1

CÓDIGO DE BARRA: 7908221692697



REF.: AR0412-MIX2

CÓDIGO DE BARRA: 7908221692703

ROLOS DE LÃ

LÃ ARTESÃO

50 g - 90 m

PACOTE COM 5 NOVELO

NCM: 5511.10.00 IPI: 0%

R\$ 20,00

PREÇO PACOTE



Tex 555



Crochê
6 a 8 mm



Tricô
5 a 7 mm



Tear



REF.: LA0001-1

CÓDIGO DE BARRA: 7908221672828



REF.: LA0001-3

CÓDIGO DE BARRA: 7908221672835



REF.: LA0001-4

CÓDIGO DE BARRA: 7908221672842



REF.: LA0001-5

CÓDIGO DE BARRA: 7908221672859



REF.: LA0001-6

CÓDIGO DE BARRA: 7908221672866



REF.: LA0001-7

CÓDIGO DE BARRA: 7908221672873



REF.: LA0001-8

CÓDIGO DE BARRA: 7908221672880



REF.: LA0001-9

CÓDIGO DE BARRA: 7908221672897



REF.: LA0001-19

CÓDIGO DE BARRA: 7908221672910



REF.: LA0001-20

CÓDIGO DE BARRA: 7908221672903



REF.: LA0001-21

CÓDIGO DE BARRA: 7908221672927



REF.: LA0001-28

CÓDIGO DE BARRA: 7908221672934

ROLOS DE LÃ



REF.: LA0001-31

CÓDIGO DE BARRA: 7908221673139



REF.: LA0001-32

CÓDIGO DE BARRA: 7908221673122



REF.: LA0001-33

CÓDIGO DE BARRA: 7908221673115



REF.: LA0001-34

CÓDIGO DE BARRA: 7908221673108



REF.: LA0001-35

CÓDIGO DE BARRA: 7908221673092



REF.: LA0001-36

CÓDIGO DE BARRA: 7908221673085



REF.: LA0001-37

CÓDIGO DE BARRA: 7908221673078



REF.: LA0001-39

CÓDIGO DE BARRA: 7908221673061



REF.: LA0001-40

CÓDIGO DE BARRA: 7908221673054



REF.: LA0001-42

CÓDIGO DE BARRA: 7908221673047



REF.: LA0001-46

CÓDIGO DE BARRA: 7908221673030



REF.: LA0001-48

CÓDIGO DE BARRA: 7908221673016



REF.: LA0001-50

CÓDIGO DE BARRA: 7908221673009



REF.: LA0001-52

CÓDIGO DE BARRA: 7908221672989



REF.: LA0001-53

CÓDIGO DE BARRA: 7908221672996



REF.: LA0001-56

CÓDIGO DE BARRA: 7908221672972



REF.: LA0001-61

CÓDIGO DE BARRA: 7908221672965



REF.: LA0001-64

CÓDIGO DE BARRA: 7908221672958

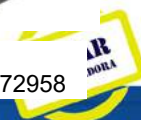

FIO DE MALHA 1KG



REF.: AR2023-3

FIO DE MALHA PARA TRICÔ 2 CM - PACOTE COM 1 KG

COR: BRANCO

CÓDIGO DE BARRA: 7908221638435

NCM: 5401.10.12 IPI: 0%

FRAÇÃO UNIDADE

R\$ 71,70

PREÇO UNITÁRIO



REF.: AR2023-5

COR: OFF WHITE

CÓDIGO DE BARRA: 7908221638459

NCM: 5401.10.12 IPI: 0%



REF.: AR2023-8

COR: BEGE

CÓDIGO DE BARRA: 7908221638480

NCM: 5401.10.12 IPI: 0%



REF.: AR2023-7

COR: BEGE ESCURO

CÓDIGO DE BARRA: 7908221638473

NCM: 5401.10.12 IPI: 0%



REF.: AR2023-11

COR: AMARELO

CÓDIGO DE BARRA: 7908221638510

NCM: 5401.10.12 IPI: 0%



REF.: AR2023-13

COR: ROSA BEBÊ

CÓDIGO DE BARRA: 7908221638534

NCM: 5401.10.12 IPI: 0%



REF.: AR2023-9

COR: ROSA

CÓDIGO DE BARRA: 7908221638497

NCM: 5401.10.12 IPI: 0%



REF.: AR2023-1

COR: VERMELHO

CÓDIGO DE BARRA: 7908221638411

NCM: 5401.10.12 IPI: 0%



REF.: AR2023-14

COR: ROXO

CÓDIGO DE BARRA: 7908221638541

NCM: 5401.10.12 IPI: 0%



REF.: AR2023-16

COR: AZUL MARINHO

CÓDIGO DE BARRA: 7908221638565

NCM: 5401.10.12 IPI: 0%



REF.: AR2023-15

COR: AZUL ROYAL

CÓDIGO DE BARRA: 7908221638558

NCM: 5401.10.12 IPI: 0%



REF.: AR2023-4

COR: AZUL

CÓDIGO DE BARRA: 7908221638442

NCM: 5401.10.12 IPI: 0%



REF.: AR2023-6

COR: AZUL BEBE

CÓDIGO DE BARRA: 7908221638466

NCM: 5401.10.12 IPI: 0%



REF.: AR2023-10

COR: VERDE ÁGUA

CÓDIGO DE BARRA: 7908221638503

NCM: 5401.10.12 IPI: 0%



REF.: AR2023-12

COR: CINZA CLARO

CÓDIGO DE BARRA: 7908221638527

NCM: 5401.10.12 IPI: 0%



REF.: AR2023-2

COR: PRETO

CÓDIGO DE BARRA: 7908221638428

NCM: 5401.10.12 IPI: 0%

FIO DE POMPOM



REF.: POM2-01

FIO DE POMPOM 25M

CÓDIGO DE BARRA: 7908221655494

NCM: 58089000 IPI: 0%

CX MASTER 100 UND

R\$ 13,00

PREÇO UNIDADE

FRAÇÃO UNIDADE

R\$ 14,50

PREÇO UNIDADE



MODO DE EMBALAGEM



REF.: POM2-01

FIO DE POMPOM 25M

CÓDIGO DE BARRA: 7908221655494

NCM: 58089000 IPI: 0%

REF.: POM2-02

FIO DE POMPOM 25M

CÓDIGO DE BARRA: 7908221655500

NCM: 58089000 IPI: 0%

REF.: POM2-09

FIO DE POMPOM 25M

CÓDIGO DE BARRA: 7908221655548

NCM: 58089000 IPI: 0%

REF.: POM2-15

FIO DE POMPOM 25M

CÓDIGO DE BARRA: 7908221655579

NCM: 58089000 IPI: 0%



REF.: POM2-07

FIO DE POMPOM 25M

CÓDIGO DE BARRA: 7908221655531

NCM: 58089000 IPI: 0%

REF.: POM2-16

FIO DE POMPOM 25M

CÓDIGO DE BARRA: 7908221655586

NCM: 58089000 IPI: 0%

REF.: POM2-22

FIO DE POMPOM 25M

CÓDIGO DE BARRA: 7908221655630

NCM: 58089000 IPI: 0%

REF.: POM2-25

FIO DE POMPOM 25M

CÓDIGO DE BARRA: 7908221655654

NCM: 58089000 IPI: 0%

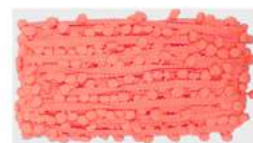

REF.: POM2-23

FIO DE POMPOM 25M

CÓDIGO DE BARRA: 7908221655647

NCM: 58089000 IPI: 0%

REF.: POM2-26

FIO DE POMPOM 25M

CÓDIGO DE BARRA: 7908221655661

NCM: 58089000 IPI: 0%

REF.: POM2-190

FIO DE POMPOM 25M

CÓDIGO DE BARRA: 7908221655807

NCM: 58089000 IPI: 0%

REF.: POM2-27

FIO DE POMPOM 25M

CÓDIGO DE BARRA: 7908221655678

NCM: 58089000 IPI: 0%



REF.: POM2-14

FIO DE POMPOM 25M

CÓDIGO DE BARRA: 7908221655562

NCM: 58089000 IPI: 0%

REF.: POM2-05

FIO DE POMPOM 25M

CÓDIGO DE BARRA: 7908221655524

NCM: 58089000 IPI: 0%

REF.: POM2-04

FIO DE POMPOM 25M

CÓDIGO DE BARRA: 7908221655517

NCM: 58089000 IPI: 0%

REF.: POM2-91

FIO DE POMPOM 25M

CÓDIGO DE BARRA: 7908221655746

NCM: 58089000 IPI: 0%



FIO DE POMPOM



REF: POM2-29

FIO DE POMPOM 25M

CÓDIGO DE BARRA: 7908221655685

NCM: 58089000 IPI: 0%



REF: POM2-35

FIO DE POMPOM 25M

CÓDIGO DE BARRA: 7908221655821

NCM: 58089000 IPI: 0%

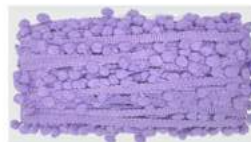

REF: POM2-21

FIO DE POMPOM 25M

CÓDIGO DE BARRA: 7908221655623

NCM: 58089000 IPI: 0%



REF: POM2-154

FIO DE POMPOM 25M

CÓDIGO DE BARRA: 7908221655777

NCM: 58089000 IPI: 0%



REF: POM2-40

FIO DE POMPOM 25M

CÓDIGO DE BARRA: 7908221655708

NCM: 58089000 IPI: 0%



REF: POM2-47

FIO DE POMPOM 25M

CÓDIGO DE BARRA: 7908221655715

NCM: 58089000 IPI: 0%



REF: POM2-20

FIO DE POMPOM 25M

CÓDIGO DE BARRA: 7908221655616

NCM: 58089000 IPI: 0%

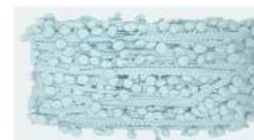

REF: POM2-104

FIO DE POMPOM 25M

CÓDIGO DE BARRA: 7908221655555

NCM: 58089000 IPI: 0%



REF: POM2-99

FIO DE POMPOM 25M

CÓDIGO DE BARRA: 7908221655760

NCM: 58089000 IPI: 0%



REF: POM2-19

FIO DE POMPOM 25M

CÓDIGO DE BARRA: 7908221655593

NCM: 58089000 IPI: 0%



REF: POM2-55

FIO DE POMPOM 25M

CÓDIGO DE BARRA: 7908221655722

NCM: 58089000 IPI: 0%



REF: POM2-18

FIO DE POMPOM 25M

CÓDIGO DE BARRA: 7908221655593

NCM: 58089000 IPI: 0%



REF: POM2-32

FIO DE POMPOM 25M

CÓDIGO DE BARRA: 7908221655692

NCM: 58089000 IPI: 0%



REF: POM2-39

FIO DE POMPOM 25M

CÓDIGO DE BARRA: 7908221655814

NCM: 58089000 IPI: 0%



REF: POM2-173

FIO DE POMPOM 25M

CÓDIGO DE BARRA: 7908221655784

NCM: 58089000 IPI: 0%



REF: POM2-92

FIO DE POMPOM 25M

CÓDIGO DE BARRA: 7908221655753

NCM: 58089000 IPI: 0%

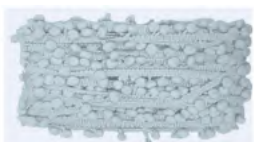

REF: POM2-59

FIO DE POMPOM 25M

CÓDIGO DE BARRA: 7908221655739

NCM: 58089000 IPI: 0%



REF: POM2-179

FIO DE POMPOM 25M

CÓDIGO DE BARRA: 7908221655791

NCM: 58089000 IPI: 0%

FIO DE POMPOM



REF.: POM2-C

FIO DE POMPOM 25m
CÓDIGO DE BARRA: 7908221655852
NCM: 58089000 IPI: 0%

CX MASTER 100 UND **FRAÇÃO UNIDADE**

R\$ 14,00 **R\$ 15,50**
PREÇO UNIDADE PREÇO UNIDADE

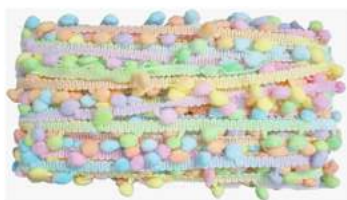

REF.: POM2-D

FIO DE POMPOM 25m
CÓDIGO DE BARRA: 7908221655869
NCM: 58089000 IPI: 0%

CX MASTER 100 UND **FRAÇÃO UNIDADE**

R\$ 14,00 **R\$ 15,50**
PREÇO UNIDADE PREÇO UNIDADE

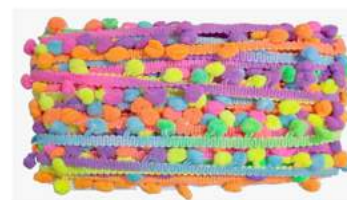

REF.: POM2-A

FIO DE POMPOM 25m
CÓDIGO DE BARRA: 7908221655838
NCM: 58089000 IPI: 0%

CX MASTER 100 UND **FRAÇÃO UNIDADE**

R\$ 14,00 **R\$ 15,50**
PREÇO UNIDADE PREÇO UNIDADE



REF.: POM2-B

FIO DE POMPOM 25M
CÓDIGO DE BARRA: 7908221655845
NCM: 58089000 IPI: 0%

CX MASTER 100 UND **FRAÇÃO UNIDADE**

R\$ 14,00 **R\$ 15,50**
PREÇO UNIDADE PREÇO UNIDADE



REF.: AR0048-1

PASSAMANARIA 3CM - 20M
CÓDIGO DE BARRA: 7908221657320
NCM: 58089000 IPI: 0%

CX MASTER 100 UND **FRAÇÃO UNIDADE**

R\$ 29,35 **R\$ 32,30**
PREÇO UNIDADE PREÇO UNIDADE



REF.: AR0048-3

PASSAMANARIA 1.3CM - 20M
CÓDIGO DE BARRA: 7908221657344
NCM: 58089000 IPI: 0%

CX MASTER 100 UND **FRAÇÃO UNIDADE**

R\$ 19,55 **R\$ 21,50**
PREÇO UNIDADE PREÇO UNIDADE

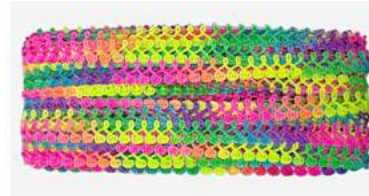
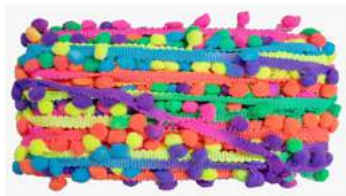

REF.: AR0048-2

PASSAMANARIA 6CM - 20M
CÓDIGO DE BARRA: 7908221657337
NCM: 58089000 IPI: 0%

CX MASTER 50 UND **FRAÇÃO UNIDADE**

R\$ 44,00 **R\$ 48,50**
PREÇO UNIDADE PREÇO UNIDADE

REF.: AR0048-9

PASSAMANARIA 5.3 cm - 10 JARDAS
CÓDIGO DE BARRA: 7908221657405
NCM: 58089000 IPI: 0%

CX MASTER 100 UND **FRAÇÃO UNIDADE**

R\$ 15,90 **R\$ 17,50**
PREÇO UNIDADE PREÇO UNIDADE

POMPOM

MIX POMPOM COLORIDO

KIT COM 70 UNIDADES:

40 unidades 10 mm

20 unidades 20 mm

10 unidades 30 mm

FRAÇÃO 12 PACOTES

R\$ 2,75

PREÇO PACOTE

NCM: 58089000 IPI: 0%

CORES DISPONÍVEIS:



REF.: AR0095-2

MIX POMPOM MOD.2

CÓD.BARRA: 7908221670244

NCM: 58089000 IPI: 0%



REF.: ESGOTADO

MIX POMPOM MOD.3

CÓD.BARRA: 7908221670251

NCM: 58089000 IPI: 0%



REF.: AR0095-4

MIX POMPOM MOD.4

CÓD.BARRA: 7908221670268

NCM: 58089000 IPI: 0%



REF.: AR0095-11

MIX POMPOM MOD.11

CÓD.BARRA: 7908221670336

NCM: 58089000 IPI: 0%



REF.: AR0095-5

MIX POMPOM MOD.5

CÓD.BARRA: 7908221670275

NCM: 58089000 IPI: 0%



REF.: AR0095-6

MIX POMPOM MOD.6

CÓD.BARRA: 7908221670282

NCM: 58089000 IPI: 0%



REF.: AR0095-7

MIX POMPOM MOD.7

CÓD.BARRA: 7908221670299

NCM: 58089000 IPI: 0%



REF.: AR0095-12

MIX POMPOM MOD.12

CÓD.BARRA: 7908221670343

NCM: 58089000 IPI: 0%



REF.: AR0095-8

MIX POMPOM MOD.8

CÓD.BARRA: 7908221670305

NCM: 58089000 IPI: 0%



REF.: AR0095-9

MIX POMPOM MOD.9

CÓD.BARRA: 7908221670312

NCM: 58089000 IPI: 0%



REF.: AR0095-10

MIX POMPOM MOD.10

CÓD.BARRA: 7908221670329

NCM: 58089000 IPI: 0%



REF.: ESGOTADO

MIX POMPOM MOD. 1

CÓD.BARRA: 7908221670237

NCM: 58089000 IPI: 0%



POMPOM



1 cm

REF.: AR0079-1

POMPOM 1 cm - 1000 UND

CÓD.BARRA: 7908221669484

NCM: 58089000 IPI: 0%

FRAÇÃO 12 PACOTES

R\$ 12,50

PREÇO PACOTE



MODO DE EMBALAGEM

OUTRAS CORES:



REF.: AR0079-10

POMPOM 1 cm - 1000 UND

CÓD.BARRA: 7908221669576

NCM: 58089000 IPI: 0%



REF.: AR0079-16

POMPOM 1 cm - 1000 UND

CÓD.BARRA: 7908221669392

NCM: 58089000 IPI: 0%



REF.: AR0079-19

POMPOM 1 cm - 1000 UND

CÓD.BARRA: 7908221669422

NCM: 58089000 IPI: 0%



REF.: AR0079-7

POMPOM 1 cm - 1000 UND

CÓD.BARRA: 7908221669545

NCM: 58089000 IPI: 0%



REF.: AR0079-8

POMPOM 1 cm - 1000 UND

CÓD.BARRA: 7908221669552

NCM: 58089000 IPI: 0%



REF.: AR0079-2

POMPOM 1 cm - 1000 UND

CÓD.BARRA: 7908221669491

NCM: 58089000 IPI: 0%



REF.: AR0079-17

POMPOM 1 cm - 1000 UND

CÓD.BARRA: 7908221669408

NCM: 58089000 IPI: 0%



REF.: AR0079-6

POMPOM 1 cm - 1000 UND

CÓD.BARRA: 7908221669538

NCM: 58089000 IPI: 0%



REF.: AR0079-15

POMPOM 1 cm - 1000 UND

CÓD.BARRA: 7908221669385

NCM: 58089000 IPI: 0%



REF.: AR0079-11

POMPOM 1 cm - 1000 UND

CÓD.BARRA: 7908221669583

NCM: 58089000 IPI: 0%



REF.: AR0079-12

POMPOM 1 cm - 1000 UND

CÓD.BARRA: 7908221669590

NCM: 58089000 IPI: 0%



REF.: AR0079-13

POMPOM 1 cm - 1000 UND

CÓD.BARRA: 7908221669606

NCM: 58089000 IPI: 0%



REF.: AR0079-14

POMPOM 1 cm - 1000 UND

CÓD.BARRA: 7908221669613

NCM: 58089000 IPI: 0%



REF.: AR0079-4

POMPOM 1 cm - 1000 UND

CÓD.BARRA: 7908221669514

NCM: 58089000 IPI: 0%



REF.: AR0079-18

POMPOM 1 cm - 1000 UND

CÓD.BARRA: 7908221669415

NCM: 58089000 IPI: 0%



REF.: AR0079-20

POMPOM 1 cm - 1000 UND

CÓD.BARRA: 7908221669439

NCM: 58089000 IPI: 0%



REF.: AR0079-5

POMPOM 1 cm - 1000 UND

CÓD.BARRA: 7908221669521

NCM: 58089000 IPI: 0%



REF.: AR0079-9

POMPOM 1 cm - 1000 UND

CÓD.BARRA: 7908221669569

NCM: 58089000 IPI: 0%



REF.: AR0079-3

POMPOM 1 cm - 1000 UND

CÓD.BARRA: 7908221669507

NCM: 58089000 IPI: 0%

POMPOM



1,4 cm

REF.: AR0081-1

POMPOM 1,4 cm - 100 UND

CÓD.BARRA: 7908221604041

NCM: 58089000 IPI: 0%

FRAÇÃO 12 PACOTES

R\$ 3,10

PREÇO PACOTE



MODO DE EMBALAGEM

OUTRAS CORES:



REF.: AR0081-2

POMPOM 1,4 cm - 100 UND

CÓD.BARRA: 7908221604058

NCM: 58089000 IPI: 0%



REF.: AR0081-3

POMPOM 1,4 cm - 100 UND

CÓD.BARRA: 7908221604065

NCM: 58089000 IPI: 0%



REF.: AR0081-4

POMPOM 1,4 cm - 100 UND

CÓD.BARRA: 7908221604072

NCM: 58089000 IPI: 0%



REF.: AR0081-5

POMPOM 1,4 cm - 100 UND

CÓD.BARRA: 7908221604089

NCM: 58089000 IPI: 0%



REF.: AR0081-6

POMPOM 1,4 cm - 100 UND

CÓD.BARRA: 7908221604096

NCM: 58089000 IPI: 0%



REF.: AR0081-7

POMPOM 1,4 cm - 100 UND

CÓD.BARRA: 7908221604102

NCM: 58089000 IPI: 0%



REF.: AR0081-8

POMPOM 1,4 cm - 100 UND

CÓD.BARRA: 7908221604119

NCM: 58089000 IPI: 0%



REF.: AR0081-9

POMPOM 1,4 cm - 100 UND

CÓD.BARRA: 7908221604126

NCM: 58089000 IPI: 0%



REF.: AR0081-10

POMPOM 1,4 cm - 100 UND

CÓD.BARRA: 7908221604133

NCM: 58089000 IPI: 0%



REF.: AR0081-11

POMPOM 1,4 cm - 100 UND

CÓD.BARRA: 7908221604140

NCM: 58089000 IPI: 0%



REF.: AR0081-12

POMPOM 1,4 cm - 100 UND

CÓD.BARRA: 7908221604157

NCM: 58089000 IPI: 0%



REF.: AR0081-13

POMPOM 1,4 cm - 100 UND

CÓD.BARRA: 7908221604164

NCM: 58089000 IPI: 0%



REF.: AR0081-14

POMPOM 1,4 cm - 100 UND

CÓD.BARRA: 7908221604171

NCM: 58089000 IPI: 0%



REF.: AR0081-15

POMPOM 1,4 cm - 100 UND

CÓD.BARRA: 7908221604188

NCM: 58089000 IPI: 0%



REF.: AR0081-16

POMPOM 1,4 cm - 100 UND

CÓD.BARRA: 7908221604195

NCM: 58089000 IPI: 0%



REF.: AR0081-17

POMPOM 1,4 cm - 100 UND

CÓD.BARRA: 7908221604201

NCM: 58089000 IPI: 0%



REF.: AR0081-18

POMPOM 1,4 cm - 100 UND

CÓD.BARRA: 7908221604218

NCM: 58089000 IPI: 0%



REF.: AR0081-19

POMPOM 1,4 cm - 100 UND

CÓD.BARRA: 7908221604225

NCM: 58089000 IPI: 0%



REF.: AR0081-20

POMPOM 1,4 cm - 100 UND

CÓD.BARRA: 7908221604232

NCM: 58089000 IPI: 0%



REF.: AR0081-21

POMPOM 1,4 cm - 100 UND

CÓD.BARRA: 7908221604249

NCM: 58089000 IPI: 0%



REF.: AR0081-22

POMPOM 1,4 cm - 100 UND

CÓD.BARRA: 7908221604256

NCM: 58089000 IPI: 0%



REF.: AR0081-23

POMPOM 1,4 cm - 100 UND

CÓD.BARRA: 7908221604263

NCM: 58089000 IPI: 0%



REF.: AR0081-24

POMPOM 1,4 cm - 100 UND

CÓD.BARRA: 7908221604270

NCM: 58089000 IPI: 0%



POMPOM



2 cm

REF.: AR0080-1

POMPOM 2 cm - 100 UND

CÓD.BARRA: 7908221604287

NCM: 39269090 IPI: 9,75%

FRAÇÃO 12 PACOTES

R\$ 5,80

PREÇO PACOTE



MODO DE EMBALAGEM

OUTRAS CORES:



REF.: AR0080-3

POMPOM 2 cm

CÓD.BARRA: 7908221604300

NCM: 39269090 IPI: 9,75%



REF.: AR0080-4

POMPOM 2 cm

CÓD.BARRA: 7908221604317

NCM: 39269090 IPI: 9,75%



REF.: AR0080-5

POMPOM 2 cm

CÓD.BARRA: 7908221604324

NCM: 39269090 IPI: 9,75%



REF.: AR0080-6

POMPOM 2 cm

CÓD.BARRA: 7908221604331

NCM: 39269090 IPI: 9,75%



REF.: AR0080-7

POMPOM 2 cm

CÓD.BARRA: 7908221604348

NCM: 39269090 IPI: 9,75%



REF.: AR0080-12

POMPOM 2 cm

CÓD.BARRA: 7908221604393

NCM: 39269090 IPI: 9,75%



REF.: AR0080-11

POMPOM 2 cm

CÓD.BARRA: 7908221604386

NCM: 39269090 IPI: 9,75%



REF.: AR0080-13

POMPOM 2 cm

CÓD.BARRA: 7908221604409

NCM: 39269090 IPI: 9,75%



REF.: AR0080-10

POMPOM 2 cm

CÓD.BARRA: 7908221604379

NCM: 39269090 IPI: 9,75%



REF.: AR0080-9

POMPOM 2 cm

CÓD.BARRA: 7908221604362

NCM: 39269090 IPI: 9,75%



REF.: AR0080-8

POMPOM 2 cm

CÓD.BARRA: 7908221604355

NCM: 39269090 IPI: 9,75%



REF.: AR0080-14

POMPOM 2 cm

CÓD.BARRA: 7908221604416

NCM: 39269090 IPI: 9,75%



REF.: AR0080-15

POMPOM 2 cm

CÓD.BARRA: 7908221604423

NCM: 39269090 IPI: 9,75%



REF.: AR0080-21

POMPOM 2 cm

CÓD.BARRA: 7908221604485

NCM: 39269090 IPI: 9,75%



REF.: AR0080-17

POMPOM 2 cm

CÓD.BARRA: 7908221604447

NCM: 39269090 IPI: 9,75%



REF.: AR0080-20

POMPOM 2 cm

CÓD.BARRA: 7908221604478

NCM: 39269090 IPI: 9,75%



REF.: AR0080-16

POMPOM 2 cm

CÓD.BARRA: 7908221604430

NCM: 39269090 IPI: 9,75%



REF.: AR0080-18

POMPOM 2 cm

CÓD.BARRA: 7908221604454

NCM: 39269090 IPI: 9,75%



REF.: AR0080-19

POMPOM 2 cm

CÓD.BARRA: 7908221604461

NCM: 39269090 IPI: 9,75%



REF.: AR0080-23

POMPOM 2 cm

CÓD.BARRA: 7908221604508

NCM: 39269090 IPI: 9,75%



REF.: AR0080-2

POMPOM 2 cm

CÓD.BARRA: 7908221604294

NCM: 39269090 IPI: 9,75%



REF.: AR0080-1

POMPOM 2 cm

CÓD.BARRA: 7908221604287

NCM: 39269090 IPI: 9,75%



POMPOM BICOLOR



2 cm

POMPOM BICOLOR 2 CM PACOTE COM 100 UNIDADES

FRAÇÃO 12 PACOTES DA MESMA COR

R\$ 5,50

PREÇO PACOTE



MODO DE EMBALAGEM



REF.: AR0082-B1

COR: BRANCO/AMARELO

CÓDIGO DE BARRA: 7908221604522

NCM: 5808.90.00 IPI: 0%



REF.: AR0082-B7

COR: BRANCO/BEGE

CÓDIGO DE BARRA: 7908221604584

NCM: 5808.90.00 IPI: 0%



REF.: AR0082-B15

COR: BRANCO/LARANJA

CÓDIGO DE BARRA: 7908221638367

NCM: 5808.90.00 IPI: 0%



ESGOTADO

REF.: AR0082-B4

COR: BRANCO/VERMELHO

CÓDIGO DE BARRA: 7908221604553

NCM: 5808.90.00 IPI: 0%



REF.: AR0082-B6

COR: BRANCO/ROSA

CÓDIGO DE BARRA: 7908221604577

NCM: 5808.90.00 IPI: 0%



REF.: AR0082-B3

COR: BRANCO/PINK

CÓDIGO DE BARRA: 7908221604546

NCM: 5808.90.00 IPI: 0%



REF.: AR0082-B20

COR: ROSA NEON

CÓDIGO DE BARRA: 7908221641251

NCM: 5808.90.00 IPI: 0%



REF.: AR0082-B16

COR: BRANCO/ ROXO

CÓDIGO DE BARRA: 7908221638374

NCM: 5808.90.00 IPI: 0%



REF.: AR0082-B18

COR: BRANCO/ AZUL

CÓDIGO DE BARRA: 7908221638398

NCM: 5808.90.00 IPI: 0%



REF.: AR0082-B17

COR: BRANCO/ VERDE

CÓDIGO DE BARRA: 7908221638381

NCM: 5808.90.00 IPI: 0%



REF.:AR0082-B14

COR: BRANCO/VERDE

CÓDIGO DE BARRA: 7908221638350

NCM: 5808.90.00 IPI: 0%



REF.: AR0082-B8

COR: BRANCO/VERDE

CÓDIGO DE BARRA: 7908221604591

NCM: 5808.90.00 IPI: 0%



REF.: AR0082-B10

COR: BRANCO/MARROM CAFÉ

CÓDIGO DE BARRA: 7908221604614

NCM: 5808.90.00 IPI: 0%



REF.: AR0082-B12

COR: BRANCO/MARROM

CÓDIGO DE BARRA: 7908221604638

NCM: 5808.90.00 IPI: 0%



REF.: AR0082-B9

COR: BRANCO/PRETO

CÓDIGO DE BARRA: 7908221604607

NCM: 5808.90.00 IPI: 0%



POMPOM

**REF.: AR0085-2**

POMPOM 3,5 cm - 200 UNIDADES

CÓDIGO DE BARRA: 7908221666483

NCM: 58089000 IPI: 0%

FRAÇÃO PACOTE**R\$ 89,00**

PREÇO PACOTE

**REF.: AR0085-1**

POMPOM 3,5 cm - 200 UNIDADES

CÓDIGO DE BARRA: 7908221666476

NCM: 58089000 IPI: 0%

FRAÇÃO PACOTE**R\$ 89,00**

PREÇO PACOTE

**REF.: AR0085-3**

POMPOM 3,5 cm - 200 UNIDADES

CÓDIGO DE BARRA: 7908221666490

NCM: 58089000 IPI: 0%

FRAÇÃO PACOTE**R\$ 89,00**

PREÇO PACOTE

**REF.: AR0089-1**

POMPOM MULTICOR 4 cm - 100 UNID

CÓDIGO DE BARRA: 7908221666513

NCM: 58089000 IPI: 0%

FRAÇÃO PACOTE C/100 UNID**R\$ 44,50**

PREÇO PACOTE

**REF.: AR0089-2**

POMPOM MULTICOR 4 cm - 100 UNID

CÓDIGO DE BARRA: 7908221666520

NCM: 58089000 IPI: 0%

FRAÇÃO PACOTE C/100 UNID**R\$ 44,50**

PREÇO PACOTE

**REF.: AR0089-4**

POMPOM MULTICOR 4 cm - 100 UNID

CÓDIGO DE BARRA: 7908221666544

NCM: 58089000 IPI: 0%

FRAÇÃO PACOTE C/100 UNID**R\$ 44,50**

PREÇO PACOTE

**REF.: AR0089-3**

POMPOM MULTICOR 4 cm - 100 UNID

CÓDIGO DE BARRA: 7908221666537

NCM: 58089000 IPI: 0%

FRAÇÃO PACOTE C/100 UNID**R\$ 44,50**

PREÇO PACOTE

POMPOM



1,4 cm

OUTRAS CORES:



REF.: AR0091-7

POMPOM METALOIDE 1,4 cm
CÓD.BARRA: 7908221669309
NCM: 39269090 IPI: 9,75%



REF.: AR0091-6

POMPOM METALOIDE 1,4 cm
CÓD.BARRA: 7908221669293
NCM: 39269090 IPI: 9,75%



REF.: AR0091-2

POMPOM METALOIDE 1,4 cm
CÓD.BARRA: 7908221669255
NCM: 58089000 IPI: 0%



REF.: AR0091-4

POMPOM METALOIDE 1,4 cm
CÓD.BARRA: 7908221669279
NCM: 39269090 IPI: 9,75%



REF.: AR0091-5

POMPOM METALOIDE 1,4 cm
CÓD.BARRA: 7908221669286
NCM: 39269090 IPI: 9,75%



REF.: AR0091-3

POMPOM METALOIDE 1,4 cm
CÓD.BARRA: 7908221669262
NCM: 39269090 IPI: 9,75%



REF.: AR0091-9

POMPOM METALOIDE 1,4 cm
CÓD.BARRA: 7908221669323
NCM: 39269090 IPI: 9,75%



REF.: AR0091-8

POMPOM METALOIDE 1,4 cm
CÓD.BARRA: 7908221669316
NCM: 39269090 IPI: 9,75%

REF.: AR0091-1

POMPOM C/ METALOIDE 1,4 cm - PCT C/ 100 UNID
CÓD.BARRA: 7908221669248
NCM: 5808.90.00 IPI: 0%
FRAÇÃO 12 PACOTES

R\$ 3,05

PREÇO PACOTE



MODO DE EMBALAGEM



2 cm

OUTRAS CORES:



REF.: AR0092-7

POMPOM METALOIDE 2 cm
CÓD.BARRA: 7908221669682
NCM: 39269090 IPI: 9,75%



REF.: AR0092-6

POMPOM METALOIDE 2 cm
CÓD.BARRA: 7908221669675
NCM: 39269090 IPI: 9,75%



REF.: AR0092-2

POMPOM METALOIDE 2 cm
CÓD.BARRA: 7908221669637
NCM: 58089000 IPI: 0%



REF.: AR0092-4

POMPOM METALOIDE 2 cm
CÓD.BARRA: 7908221669651
NCM: 39269090 IPI: 9,75%



REF.: AR0092-5

POMPOM METALOIDE 2 cm
CÓD.BARRA: 7908221669668
NCM: 39269090 IPI: 9,75%



REF.: AR0092-3

POMPOM METALOIDE 2 cm
CÓD.BARRA: 7908221669644
NCM: 39269090 IPI: 9,75%



REF.: AR0092-9

POMPOM METALOIDE 2 cm
CÓD.BARRA: 7908221669705
NCM: 39269090 IPI: 9,75%



REF.: AR0092-8

POMPOM METALOIDE 2 cm
CÓD.BARRA: 7908221669699
NCM: 39269090 IPI: 9,75%

REF.: AR0092-1

POMPOM C/ METALOIDE 2 cm - PCT C/ 100 UNID
CÓD.BARRA: 7908221669620
NCM: 5808.90.00 IPI: 0%
FRAÇÃO 12 PACOTES

R\$ 5,20

PREÇO PACOTE



MODO DE EMBALAGEM



POMPOM 2,8 CM

REF.: AR0084-W

POMPOM 2.8CM - 1X100PCS

CÓDIGO DE BARRA: 7908221655999

NCM: 58089000 IPI: 0%

FRAÇÃO PACOTE

R\$ 42,00

PREÇO PACOTE



REF.: AR0084-12

POMPOM 2.8CM - 1X100PCS

CÓDIGO DE BARRA: 7908221656040

NCM: 58089000 IPI: 0%



REF.: AR0084-1

POMPOM 2.8CM - 1X100PCS

CÓDIGO DE BARRA: 7908221656019

NCM: 58089000 IPI: 0%



REF.: AR0084-10

POMPOM 2.8CM - 1X100PCS

CÓDIGO DE BARRA: 7908221656026

NCM: 58089000 IPI: 0%



REF.: AR0084-22

POMPOM 2.8CM - 1X100PCS

CÓDIGO DE BARRA: 7908221656071

NCM: 58089000 IPI: 0%



REF.: AR0084-24

POMPOM 2.8CM - 1X100PCS

CÓDIGO DE BARRA: 7908221656095

NCM: 58089000 IPI: 0%



REF.: AR0084-33

POMPOM 2.8CM - 1X100PCS

CÓDIGO DE BARRA: 7908221656118

NCM: 58089000 IPI: 0%



REF.: AR0084-B

POMPOM 2.8CM - 1X100PCS

CÓDIGO DE BARRA: 7908221656002

NCM: 58089000 IPI: 0%



REF.: AR0084-23

POMPOM 2.8CM - 1X100PCS

CÓDIGO DE BARRA: 7908221656088

NCM: 58089000 IPI: 0%



REF.: AR0084-20

POMPOM 2.8CM - 1X100PCS

CÓDIGO DE BARRA: 7908221656101

NCM: 58089000 IPI: 0%



REF.: AR0084-15

POMPOM 2.8CM - 1X100PCS

CÓDIGO DE BARRA: 7908221656057

NCM: 58089000 IPI: 0%



REF.: AR0084-19

POMPOM 2.8CM - 1X100PCS

CÓDIGO DE BARRA: 7908221656064

NCM: 58089000 IPI: 0%



REF.: AR0084-36

POMPOM 2.8CM - 1X100PCS

CÓDIGO DE BARRA: 7908221656125

NCM: 58089000 IPI: 0%



REF.: AR0084-8

POMPOM 2.8CM - 1X100PCS

CÓDIGO DE BARRA: 7908221656033

NCM: 58089000 IPI: 0%

POMPOM 6 CM

MODO DE EMBALAGEM



REF.: AR0086-W

POMPOM 6CM - 1X50PCS

CÓDIGO DE BARRA: 7908221656286

NCM: 58089000 IPI: 0%

FRAÇÃO PACOTE C/ 50 UNID

R\$ 31,50

PREÇO PACOTE

OUTRAS CORES:



6 CM

REF.: AR0086-42

POMPOM 6CM - 1X50PCS - CINZA

CÓDIGO DE BARRA: 7908221656231

NCM: 58089000 IPI: 0%



6 CM

REF.: AR0086-28

POMPOM 6CM - 1X50PCS - ROSA BB

CÓDIGO DE BARRA: 7908221656200

NCM: 58089000 IPI: 0%



6 CM

REF.: AR0086-7

POMPOM 6CM - 1X50PCS ROSA PASTEL

CÓDIGO DE BARRA: 7908221656156

NCM: 58089000 IPI: 0%



6 CM

REF.: AR0086-51

POMPOM 6CM - 1X50PCS - AMARELO

CÓDIGO DE BARRA: 7908221656248

NCM: 58089000 IPI: 0%



6 CM

REF.: AR0086-55

POMPOM 6CM - 1X50PCS - LARANJA

CÓDIGO DE BARRA: 7908221656262

NCM: 58089000 IPI: 0%



6 CM

REF.: AR0086-35

POMPOM 6CM - 1X50PCS - VERMELHO

CÓDIGO DE BARRA: 7908221656217

NCM: 58089000 IPI: 0%



6 CM

REF.: AR0086-25

POMPOM 6CM - 1X50PCS - PINK

CÓDIGO DE BARRA: 7908221656194

NCM: 58089000 IPI: 0%



6 CM

REF.: AR0086-52

POMPOM 6CM - 1X50PCS - CHICLETE

CÓDIGO DE BARRA: 7908221656255

NCM: 58089000 IPI: 0%



6 CM

REF.: AR0086-12

POMPOM 6CM - 1X50PCS - VINHO

CÓDIGO DE BARRA: 7908221656163

NCM: 58089000 IPI: 0%



6 CM

REF.: AR0086-39

POMPOM 6CM - 1X50PCS - ROYAL

CÓDIGO DE BARRA: 7908221656224

NCM: 58089000 IPI: 0%



6 CM

REF.: AR0086-GR

POMPOM 6CM - 1X50PCS - VERDE

CÓDIGO DE BARRA: 7908221656293

NCM: 58089000 IPI: 0%



6 CM

REF.: AR0086-14

POMPOM 6CM - 1X50PCS - MILITAR

CÓDIGO DE BARRA: 7908221656170

NCM: 58089000 IPI: 0%



6 CM

REF.: AR0086-19

POMPOM 6CM - 1X50PCS AZUL ESC.

CÓDIGO DE BARRA: 7908221656187

NCM: 58089000 IPI: 0%



6 CM

REF.: AR0086-3

POMPOM 6CM - 1X50PCS MARROM CL

CÓDIGO DE BARRA: 7908221656132

NCM: 58089000 IPI: 0%



6 CM

REF.: AR0086-5

POMPOM 6CM - 1X50PCS MARROM ESC

CÓDIGO DE BARRA: 7908221656149

NCM: 58089000 IPI: 0%



6 CM

REF.: AR0086-B

POMPOM 6CM - 1X50PCS PRETO

CÓDIGO DE BARRA: 7908221656279

NCM: 58089000 IPI: 0%



POMPOM 7 CM

MODO DE EMBALAGEM



REF.: AR0087-W

POMPOM 7CM - 1X50PCS

CÓDIGO DE BARRA: 7908221656453

NCM: 58089000 IPI: 0%

FRAÇÃO PACOTE C/ 50 UNID

R\$ 43,50

PREÇO PACOTE

OUTRAS CORES:



7 CM

REF.: AR0087-42

POMPOM 7CM - 1X50PCS

CÓDIGO DE BARRA: 7908221656408

NCM: 58089000 IPI: 0%



7 CM

REF.: AR0087-28

POMPOM 7CM - 1X50PCS

CÓDIGO DE BARRA: 7908221656378

NCM: 58089000 IPI: 0%



7 CM

REF.: AR0087-7

POMPOM 7CM - 1X50PCS

CÓDIGO DE BARRA: 7908221656323

NCM: 58089000 IPI: 0%



7 CM

REF.: AR0087-51

POMPOM 7CM - 1X50PCS

CÓDIGO DE BARRA: 7908221656415

NCM: 58089000 IPI: 0%



7 CM

REF.: AR0087-55

POMPOM 7CM - 1X50PCS

CÓDIGO DE BARRA: 7908221656439

NCM: 58089000 IPI: 0%



7 CM

REF.: AR0087-35

POMPOM 7CM - 1X50PCS

CÓDIGO DE BARRA: 7908221656385

NCM: 58089000 IPI: 0%



7 CM

REF.: AR0087-25

POMPOM 7CM - 1X50PCS

CÓDIGO DE BARRA: 7908221656361

NCM: 58089000 IPI: 0%



7 CM

REF.: AR0087-52

POMPOM 7CM - 1X50PCS

CÓDIGO DE BARRA: 7908221656422

NCM: 58089000 IPI: 0%

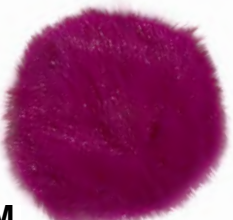

7 CM

REF.: AR0087-12

POMPOM 7CM - 1X50PCS

CÓDIGO DE BARRA: 7908221656330

NCM: 58089000 IPI: 0%



7 CM

REF.: AR0087-39

POMPOM 7CM - 1X50PCS

CÓDIGO DE BARRA: 7908221656392

NCM: 58089000 IPI: 0%



7 CM

REF.: AR0087-GR

POMPOM 7CM - 1X50PCS

CÓDIGO DE BARRA: 7908221656460

NCM: 58089000 IPI: 0%



7 CM

REF.: AR0087-14

POMPOM 7CM - 1X50PCS

CÓDIGO DE BARRA: 7908221656347

NCM: 58089000 IPI: 0%



7 CM

REF.: AR0087-19

POMPOM 7CM - 1X50PCS

CÓDIGO DE BARRA: 7908221656354

NCM: 58089000 IPI: 0%



7 CM

REF.: AR0087-3

POMPOM 7CM - 1X50PCS

CÓDIGO DE BARRA: 7908221656309

NCM: 58089000 IPI: 0%



7 CM

REF.: AR0087-5

POMPOM 7CM - 1X50PCS

CÓDIGO DE BARRA: 7908221656316

NCM: 58089000 IPI: 0%



7 CM

REF.: AR0087-B

POMPOM 7CM - 1X50PCS

CÓDIGO DE BARRA: 7908221656446

NCM: 58089000 IPI: 0%



POMPOM



REF.:AR0083-16

POMPOM 8 CM - COR: VERDE MILITAR

CÓDIGO DE BARRA: 7908221604867

NCM: 5808.90.00 IPI: 0%

CX MASTER 240 PACOTES FRAÇÃO PACOTE C/ 12 UNID

R\$ 17,90

PREÇO PACOTE

R\$ 19,70

PREÇO PACOTE



REF.: AR0083-24

POMPOM 8 CM - COR: CINZA

CÓDIGO DE BARRA: 7908221604836

NCM: 5808.90.00 IPI: 0%

CX MASTER 240 PACOTES FRAÇÃO PACOTE C/ 12 UNID

ESGOTADO

ESGOTADO



REF.:AR0083-22

POMPOM 8 CM - COR: MARROM

CÓDIGO DE BARRA: 7908221604812

NCM: 5808.90.00 IPI: 0%

CX MASTER 240 PACOTES FRAÇÃO PACOTE C/ 12 UNID

R\$ 17,90

PREÇO PACOTE

R\$ 19,70

PREÇO PACOTE



REF.:AR0083-27

POMPOM 8 CM - COR: MARROM CLARO

CÓDIGO DE BARRA: 7908221604775

NCM: 5808.90.00 IPI: 0%

CX MASTER 240 PACOTES FRAÇÃO PACOTE C/ 12 UNID

R\$ 17,90

PREÇO PACOTE

R\$ 19,70

PREÇO PACOTE



REF.:AR0083-1

POMPOM 8 CM - COR: PRETO

CÓDIGO DE BARRA

NCM: 5808.90.00 IPI: 0%

CX MASTER 240 PACOTES FRAÇÃO PACOTE C/ 12 UNID

R\$ 17,90

PREÇO PACOTE

R\$ 19,70

PREÇO PACOTE



POMPOM



REF.: AR0087-W2

POMPOM 7CM - 1X50PCS BRANCO
CÓDIGO DE BARRA: 7908221657542
NCM: 58089000 IPI: 0%

FRAÇÃO 50 UND

R\$ 0,90

PREÇO UNIDADE



REF.: AR0090-W

POMPOM 10CM - 1X50PCS BRANCO
CÓDIGO DE BARRA: 7908221657580
NCM: 58089000 IPI: 0%

FRAÇÃO 50 UND

R\$ 1,45

PREÇO UNIDADE



REF.: AR2024-200-W

PASSAMARIA DE PELÚCIA PARA CORTINA 15CM - 50 PCS
CÓDIGO DE BARRA: 7908221657504
NCM: 58089000 IPI: 0%

FRAÇÃO 50 UND

R\$ 2,70

PREÇO UNIDADE



REF.: AR0087-B2

POMPOM 7CM - 1X50PCS PRETO
CÓDIGO DE BARRA: 7908221657535
NCM: 58089000 IPI: 0%

FRAÇÃO 50 UND

R\$ 0,90

PREÇO UNIDADE



REF.: AR0090-B

POMPOM 10CM - 1X50PCS PRETO
CÓDIGO DE BARRA: 7908221657573
NCM: 58089000 IPI: 0%

FRAÇÃO 50 UND

R\$ 1,45

PREÇO UNIDADE



REF.: AR2024-200-B

PASSAMARIA DE PELÚCIA PARA CORTINA 15CM - 50 PCS
CÓDIGO DE BARRA: 7908221657498
NCM: 58089000 IPI: 0%

FRAÇÃO 50 UND

R\$ 2,70

PREÇO UNIDADE



REF.: AR0087-LC

POMPOM 7CM - 1X50PCS MARROM CLARO
CÓDIGO DE BARRA: 7908221657566
NCM: 58089000 IPI: 0%

FRAÇÃO 50 UND

R\$ 0,90

PREÇO UNIDADE



REF.: AR0090-LC

POMPOM 10CM - 1X50PCS MARROM CLARO
CÓDIGO DE BARRA: 7908221657597
NCM: 58089000 IPI: 0%

FRAÇÃO 50 UND

R\$ 1,45

PREÇO UNIDADE



REF.: AR2024-200-LC

PASSAMARIA DE PELÚCIA PARA CORTINA 15CM - 50 PCS
CÓDIGO DE BARRA: 7908221657511
NCM: 58089000 IPI: 0%

FRAÇÃO 50 UND

R\$ 2,70

PREÇO UNIDADE



REF.: AR0087-DC

POMPOM 7CM - 1X50PCS MARROM ESCURO
CÓDIGO DE BARRA: 7908221657566
NCM: 58089000 IPI: 0%

FRAÇÃO 50 UND

R\$ 0,90

PREÇO UNIDADE



REF.: AR0090-DC

POMPOM 10CM - 1X50PCS MARROM ESCURO
CÓDIGO DE BARRA: 7908221657603
NCM: 58089000 IPI: 0%

FRAÇÃO 50 UND

R\$ 1,45

PREÇO UNIDADE



REF.: AR2024-200-DC

PASSAMARIA DE PELÚCIA PARA CORTINA 15CM - 50 PCS
CÓDIGO DE BARRA: 7908221657528
NCM: 58089000 IPI: 0%

FRAÇÃO 50 UND

R\$ 2,70

PREÇO UNIDADE



POMPOM



7 CM

REF.: AR0087-M2

POMPOM MULTICOR 7CM - 1X50PCS

CÓDIGO DE BARRA: 7908221656484

NCM: 58089000 IPI: 0%

FRAÇÃO PACOTE C/ 50 UNID

R\$ 47,50

PREÇO PACOTE



7 CM

REF.: AR0087-M3

POMPOM MULTICOR 7CM - 1X50PCS

CÓDIGO DE BARRA: 7908221656491

NCM: 58089000 IPI: 0%

FRAÇÃO PACOTE C/ 50 UNID

R\$ 47,50

PREÇO PACOTE



7 CM

REF.: AR0087-M4

POMPOM MULTICOR 7CM - 1X50PCS

CÓDIGO DE BARRA: 7908221656507

NCM: 58089000 IPI: 0%

FRAÇÃO PACOTE C/ 50 UNID

R\$ 47,50

PREÇO PACOTE



7 CM

REF.: AR0087-M1

POMPOM MULTICOR 7CM - 1X50PCS

CÓDIGO DE BARRA: 7908221656477

NCM: 58089000 IPI: 0%

FRAÇÃO PACOTE C/ 50 UNID

R\$ 47,50

PREÇO PACOTE



REF.:AR080-POM

KIT PLASTICO DE ARGOLAS - FAZ DE POMPOM- 4 PCS

CÓDIGO DE BARRA: 7908221614804

NCM: 3926.90.90 IPI: 9,75%

CX MASTER 120 KITS

FRAÇÃO KIT

R\$ 10,20

PREÇO KIT

R\$ 11,25

PREÇO KIT



PRENDEDORES



REF.: LBP-33

MINI PRENDEDOR MIX CORES 4,5 cm - 1 kg

CÓDIGO DE BARRA: 7908221667664

NCM: 44209000 IPI: 0%

FRAÇÃO PACOTE 1 kg

R\$ 90,00

PREÇO PACOTE



REF.: LBP-31

MINI PRENDEDOR NATURAL 2,5 cm - 1 kg

CÓDIGO DE BARRA: 7908221667640

NCM: 44209000 IPI: 0%

FRAÇÃO PACOTE 1 kg

ESGOTADO

PREÇO PACOTE



REF.: LBP-35

MINI PRENDEDOR MIX CORES 3,5 cm - 1 kg

CÓDIGO DE BARRA: 7908221667688

NCM: 44209000 IPI: 0%

FRAÇÃO PACOTE 1 kg

R\$ 99,00

PREÇO PACOTE



REF.: LBP-34

MINI PRENDEDOR NATURAL 3,5 cm - 1 kg

CÓDIGO DE BARRA: 7908221667671

NCM: 44209000 IPI: 0%

FRAÇÃO PACOTE 1 kg

R\$ 99,00

PREÇO PACOTE



REF.: LBP-32

MINI PRENDEDOR NATURAL 4,5 cm - 1 kg

CÓDIGO DE BARRA: 7908221667657

NCM: 44209000 IPI: 0%

FRAÇÃO PACOTE 1 kg

R\$ 90,00

PREÇO PACOTE



PRENDEDORES



PRENDEDOR METAL P/ CABELO - PACOTE C/ 500 UNID

REF.:AC3001-P1

PRENDEDOR METAL P/ CABELO
MOD.1- 1X500 - APROX. 6X2 CM
CÓDIGO DE BARRA: 7908221625923
NCM: 9615.19.00 IPI: 9,75%



FRAÇÃO 500 UNID

R\$ 0,75

PREÇO UNITÁRIO

REF.:AC3001-P6

PRENDEDOR METAL P/ CABELO
MOD.6- 1X500 - APROX. 7 X 1,5CM
CÓDIGO DE BARRA: 7908221626203
NCM: 9615.19.00 IPI: 9,75%



FRAÇÃO 500 UNID

R\$ 0,80

PREÇO UNITÁRIO

REF.:AC3001-P2

PRENDEDOR METAL P/ CABELO
MOD.2- 1X500 - APROX. 5 X 3,5 CM
CÓDIGO DE BARRA: 7908221625930
NCM: 9615.19.00 IPI: 9,75%



FRAÇÃO 500 UNID

R\$ 0,75

PREÇO UNITÁRIO

REF.:AC3001-P7

PRENDEDOR METAL P/ CABELO
MOD.7- 1X500 - APROX. 7 X 3CM
CÓDIGO DE BARRA: 7908221626210
NCM: 9615.19.00 IPI: 9,75%



FRAÇÃO 500 UNID

R\$ 0,80

PREÇO UNITÁRIO

REF.:AC3001-P3

PRENDEDOR METAL P/ CABELO
MOD.3- 1X500 - APROX. 8 X 2 CM
CÓDIGO DE BARRA: 7908221625947
NCM: 9615.19.00 IPI: 9,75%



FRAÇÃO 500 UNID

R\$ 0,90

PREÇO UNITÁRIO

REF.:AC3001-P8

PRENDEDOR METAL P/ CABELO
MOD.8- 1X500 - APROX. 7 X 2 CM
CÓDIGO DE BARRA: 7908221626227
NCM: 9615.19.00 IPI: 9,75%



FRAÇÃO 500 UNID

R\$ 0,80

PREÇO UNITÁRIO

REF.:AC3001-P4

PRENDEDOR METAL P/ CABELO
MOD.4- 1X500 - APROX. 8 X 2 CM
CÓDIGO DE BARRA: 7908221625954
NCM: 9615.19.00 IPI: 9,75%



FRAÇÃO 500 UNID

R\$ 0,60

PREÇO UNITÁRIO

REF.:AC3001-P9

PRENDEDOR METAL P/ CABELO
MOD.9- 1X500 - APROX. 6 X 1,5CM
CÓDIGO DE BARRA: 7908221626234
NCM: 9615.19.00 IPI: 9,75%



FRAÇÃO 500 UNID

R\$ 0,80

PREÇO UNITÁRIO

REF.:AC3001-P5

PRENDEDOR METAL P/ CABELO
MOD.5- 1X500 - APROX. 7,5 X 3CM
CÓDIGO DE BARRA: 7908221626197
NCM: 9615.19.00 IPI: 9,75%



FRAÇÃO 500 UNID

R\$ 0,80

PREÇO UNITÁRIO

REF.:AC3001-P10

PRENDEDOR METAL P/ CABELO
MOD.5- 1X500 - APROX. 6 X 2CM
CÓDIGO DE BARRA: 7908221626241
NCM: 9615.19.00 IPI: 9,75%



FRAÇÃO 500 UNID

R\$ 0,80

PREÇO UNITÁRIO



ADESIVO PARA PRENDEDOR



MODO DE EMBALAGEM

ADESIVO PLÁSTICO P/ PRENDEDOR

REF.: AC3002-P1

ACESS. ADESIVO PLÁSTICO
P/ PRENDEDOR MOD 1 APROX 7X2CM
CÓDIGO DE BARRA: 7908221625978
NCM: 39264000 IPI: 13%

FRAÇÃO 40 UNID

R\$ 0,90

PREÇO UNITÁRIO



REF.: AC3002-P6

ACESS. ADESIVO PLÁSTICO
P/ PRENDEDOR MOD 6 APROX. 6X2,5 CM
CÓDIGO DE BARRA: 7908221626029
NCM: 39264000 IPI: 13%

FRAÇÃO 96 UNID

R\$ 0,90

PREÇO UNITÁRIO



REF.: AC3002-P2

ACESS. ADESIVO PLÁSTICO
P/ PRENDEDOR MOD 2 APROX. 7,5X3CM
CÓDIGO DE BARRA: 7908221625985
NCM: 39264000 IPI: 13%

FRAÇÃO 39 UNID

R\$ 0,90

PREÇO UNITÁRIO



REF.: AC3002-P7

ACESS. ADESIVO PLÁSTICO
P/ PRENDEDOR MOD. 7 - APROX. 7X2CM
CÓDIGO DE BARRA: 7908221626036
NCM: 39264000 IPI: 13%

FRAÇÃO 45 UNID

R\$ 0,90

PREÇO UNITÁRIO



REF.: AC3002-P3

ACESS. ADESIVO PLÁSTICO
P/ PRENDEDOR MOD 3 - APROX. 5X3,5CM
CÓDIGO DE BARRA: 7908221625992
NCM: 39264000 IPI: 13%

FRAÇÃO 40 UNID

R\$ 0,90

PREÇO UNITÁRIO



REF.: AC3002-P8

ACESS. ADESIVO PLÁSTICO
P/ PRENDEDOR MOD. 8 - APROX. 7X3CM
CÓDIGO DE BARRA: 7908221626043
NCM: 39264000 IPI: 13%

FRAÇÃO 40 UNID

R\$ 0,90

PREÇO UNITÁRIO



REF.: AC3002-P5

ACESS. ADESIVO PLÁSTICO
P/ PRENDEDOR MOD 5 - APROX. 5,5X1,5CM
CÓDIGO DE BARRA: 7908221626012
NCM: 39264000 IPI: 13%

FRAÇÃO 144 UNID

R\$ 0,90

PREÇO UNITÁRIO



BICO DE PATO



3.2 CM



REF.: AC0022-32

ACESSÓRIO BICO DE PATO 3.2CM - 1000 PCS

CÓDIGO DE BARRA: 7908221655432

NCM: 96151900 IPI: 9,75%

FRAÇÃO PCT C/ 1000 UND

R\$ 60,00

PREÇO PACOTE



3.5 CM

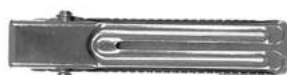

REF.: AC0002-35

ACESSÓRIO BICO DE PATO 3.5CM - 1000 PCS

CÓDIGO DE BARRA: 7908221655401

NCM: 96151900 IPI: 9,75%

FRAÇÃO PCT C/ 1000 UND

R\$ 81,00

PREÇO PACOTE



BAZAR
IMPORTADORA

MODO DE EMBALAGEM



4 CM



REF.: AC0022-40

ACESSÓRIO BICO DE PATO 4CM - 1000 PCS

CÓDIGO DE BARRA: 7908221655449

NCM: 96151900 IPI: 9,75%

FRAÇÃO PCT C/ 1000 UND

R\$ 70,00

PREÇO PACOTE



4,5 CM



REF.: AC0022-45

ACESSÓRIO BICO DE PATO 4.5CM - 1000 PCS

CÓDIGO DE BARRA: 7908221655456D

NCM: 96151900 IPI: 9,75%

FRAÇÃO PCT C/ 1000 UND

R\$ 82,00

PREÇO PACOTE



5 CM

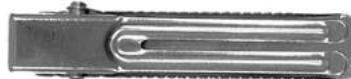

REF.: AC0002-50

ACESSÓRIO BICO DE PATO 5CM - 1000 PCS

CÓDIGO DE BARRA: 7908221655418

NCM: 96151900 IPI: 9,75%

FRAÇÃO PCT C/ 1000 UND

R\$ 115,00

PREÇO PACOTE



5,5 CM



REF.: AC0022-55

ACESSÓRIO BICO DE PATO 5.5CM - 1000 PCS

CÓDIGO DE BARRA: 7908221655463

NCM: 96151900 IPI: 9,75%

FRAÇÃO PCT C/ 1000 UND

R\$ 105,00

PREÇO PACOTE



6 CM



REF.: AC0002-60

ACESSÓRIO BICO DE PATO 6CM - 1000 PCS

CÓDIGO DE BARRA: 7908221655425

NCM: 96151900 IPI: 9,75%

FRAÇÃO PCT C/ 1000 UND

R\$ 184,00

PREÇO PACOTE



6,5 CM



REF.: AC0022-65

ACESSÓRIO BICO DE PATO 6.5CM - 1000 PCS

CÓDIGO DE BARRA: 7908221655470

NCM: 96151900 IPI: 9,75%

FRAÇÃO PCT C/ 1000 UND

R\$ 138,00

PREÇO PACOTE



7,5 CM



REF.: AC0022-75

ACESSÓRIO BICO DE PATO 7.5CM - 1000 PCS

CÓDIGO DE BARRA: 7908221655487

NCM: 96151900 IPI: 9,75%

FRAÇÃO PCT C/ 1000 UND

R\$ 150,00

PREÇO PACOTE



TIC TAC ENCAPADO

REF.: AC3000-P3

TIC-TAC AMARELO ENCAPADO
P/ CABELO - MOD. 3 - APROX 3,5 CM
CÓDIGO DE BARRA: 7908221625190
NCM: 9615.19.00 IPI: 9,75%

FRAÇÃO PCT C/200 UNID

R\$ 54,00

PREÇO PACOTE

**REF.: AC3000-P4**

TIC-TAC VERDE ENCAPADO
P/ CABELO - MOD. 4 - APROX 3,5 CM
CÓDIGO DE BARRA: 7908221625206
NCM: 9615.19.00 IPI: 9,75%

FRAÇÃO PCT C/200 UNID

R\$ 54,00

PREÇO PACOTE

**REF.: AC3000-P6**

TIC-TAC LILÁS ENCAPADO
P/ CABELO - MOD. 6 - APROX 3,5 CM
CÓDIGO DE BARRA: 7908221625220
NCM: 9615.19.00 IPI: 9,75%

FRAÇÃO PCT C/200 UNID

R\$ 54,00

PREÇO PACOTE

**REF.: AC3000-P2**

TIC-TAC PINK ENCAPADO
P/ CABELO - MOD. 2 - APROX 3,5 CM
CÓDIGO DE BARRA: 7908221625183
NCM: 9615.19.00 IPI: 9,75%

FRAÇÃO PCT C/200 UNID

R\$ 54,00

PREÇO PACOTE



PRESILHAS

REF.: AC0002-GVM

PRESILHA C/ FITA DE GORGURÃO
5CM - 1X1000 COR: VERMELHO
CÓDIGO DE BARRA: 7908221603631
NCM: 9615.19.00 IPI: 9,75%

FRAÇÃO PCT C/1000 UNID

R\$ 220,00

PREÇO PACOTE

**REF.: AC0002-GAB**

PRESILHA COM FITA DE GORGURÃO
5CM - 1X1000 COR: AZUL
CÓDIGO DE BARRA: 7908221603648
NCM: 9615.11.00 IPI: 9,75%

FRAÇÃO PCT C/1000 UNID

R\$ 220,00

PREÇO PACOTE

**REF.: AC0003-P8**

ACESSÓRIO TIPO PRENDEDOR DE
CABELO - 8 cm - 1000 UNIDADES
CÓDIGO DE BARRA: 7908221617935
NCM: 96151900 IPI: 9,75%

FRAÇÃO PACOTE

R\$ 395,00

PREÇO PACOTE



8 CM

PRESILHAS ENCAPADAS

PRESILHA ENCAPADA COM FITA DE GORGURÃO - 3,5 cm

PACOTE COM 100 UNIDADES

NCM: 9615.11.00 IPI: 9,75%



3,5 cm

FRAÇÃO PCT C/ 100 UNIDADES

R\$ 18,75

PREÇO PACOTE

PRESILHA REVESTIDA TOTALMENTE PELA FITA



REF.: AC0003.5-GBR

CÓDIGO DE BARRA: 7908221681905



REF.: AC0003.5-GP

CÓDIGO DE BARRA: 7908221681912



REF.: AC0003.5-GAM

CÓDIGO DE BARRA: 7908221681929



REF.: AC0003.5-GAO

CÓDIGO DE BARRA: 7908221681936



REF.: AC0003.5-GRX

CÓDIGO DE BARRA: 7908221681943



REF.: AC0003.5-GPK

CÓDIGO DE BARRA: 7908221681950



REF.: AC0003.5-GOW

CÓDIGO DE BARRA: 7908221681981



REF.: AC0003.5-GSM

CÓDIGO DE BARRA: 7908221681998



REF.: AC0003.5-GRB

CÓDIGO DE BARRA: 7908221682001

PRESILHAS ENCAPADAS



REF.: AC0003.5-GMC

CÓDIGO DE BARRA: 7908221682018



REF.: AC0003.5-GVDS

CÓDIGO DE BARRA: 7908221682025



REF.: AC0003.5-GGE

CÓDIGO DE BARRA: 7908221682032



REF.: AC0003.5-GLJ

CÓDIGO DE BARRA: 7908221682049



REF.: AC0003.5-GAR

CÓDIGO DE BARRA: 7908221682056



REF.: AC0003.5-GVD

CÓDIGO DE BARRA: 7908221682063



REF.: AC0003.5-GAB

CÓDIGO DE BARRA: 7908221681967



REF.: AC0003.5-GVM

CÓDIGO DE BARRA: 7908221681974

PRESILHAS ENCAPADAS

PRESILHA ENPACADA COM FITA DE GORGURÃO - 5 cm PACOTE COM 100 UNIDADES

NCM: 9615.11.00 IPI: 9,75%

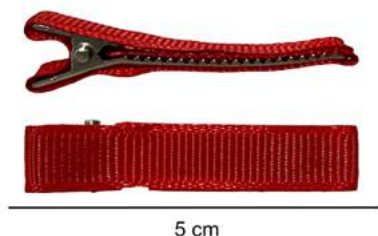

FRAÇÃO PCT C/ 100 UNIDADES

R\$ 23,50

PREÇO PACOTE

PRESILHA REVESTIDA TOTALMENTE PELA FITA



REF.: AC0002-GBR

CÓDIGO DE BARRA: 7908221603624



REF.: AC0002-GP

CÓDIGO DE BARRA: 7908221603617



REF.: AC0002-GAM

CÓDIGO DE BARRA: 7908221681790



REF.: AC0002-GAO

CÓDIGO DE BARRA: 7908221681806



REF.: AC0002-GRX

CÓDIGO DE BARRA: 7908221681813



REF.: AC0002-GPK

CÓDIGO DE BARRA: 7908221603662



REF.: AC0002-GOW

CÓDIGO DE BARRA: 7908221681820



REF.: AC0002-GSM

CÓDIGO DE BARRA: 7908221681837



REF.: AC0002-GRB

CÓDIGO DE BARRA: 7908221603655

PRESILHAS ENCAPADAS



REF.: AC0002-GMC

CÓDIGO DE BARRA: 7908221681844



REF.: AC0002-GVDS

CÓDIGO DE BARRA: 7908221681851



REF.: AC0002-GGE

CÓDIGO DE BARRA: 7908221681868



REF.: AC0002-GLJ

CÓDIGO DE BARRA: 7908221681875



REF.: AC0002-GAR

CÓDIGO DE BARRA: 7908221681882



REF.: AC0002-GVD

CÓDIGO DE BARRA: 7908221681899



REF.: AC0002-GAB

CÓDIGO DE BARRA: 7908221603648



REF.: AC0002-GVM

CÓDIGO DE BARRA: 7908221603648

FRAÇÃO PCT C/ 1000 UNIDADES

R\$ 220,00

PREÇO PACOTE

FRAÇÃO PCT C/ 100 UNIDADES

R\$ 23,50

PREÇO PACOTE

TIARA FORRADA

TIARA REVESTIDA DE CETIM

PACOTE COM 12 UNIDADES

NCM: 9505.90.00 IPI: 13%

FRAÇÃO PACOTE C/ 12 UNID

R\$ 6,60

PREÇO PACOTE



REF.: AC0006-FBR

BRANCO

CÓDIGO DE BARRA: 7908221603242



REF.: AC0006-FAO

AMARELO

CÓD. BARRA: 7908221603389



REF.: AC0006-FCR

MARROM CLARO

CÓD. BARRA: 7908221603334



REF.: AC0006-FDR

DOURADO

CÓD. BARRA: 7908221687013



REF.: AC0006-FLJ

LARANJA

CÓD. BARRA: 7908221603341



REF.: AC0006-FVM

VERMELHO

CÓD. BARRA: 7908221603228



REF.: AC0006-FRB

ROSA BB

CÓD. BARRA: 7908221603280



REF.: AC0006-FRS

ROSA CHICLETE

CÓD. BARRA: 7908221603266



REF.: AC0006-FPK

PINK

CÓD. BARRA: 7908221603273



REF.: AC0006-FRX

ROXO

CÓD. BARRA: 7908221603327



REF.: AC0006-FRXD

ROXO ESCURO

CÓD. BARRA: 7908221603310



REF.: AC0006-FAR

AZUL ROYAL

CÓD. BARRA: 790822160329



REF.: AC0006-FAM

AZUL MARINHO

CÓD. BARRA: 7908221603303



REF.: AC0006-FAB

AZUL CLARO

CÓD. BARRA: 7908221603365



REF.: AC0006-FAZ

AZUL

CÓD. BARRA: 7908221603372



REF.: AC0006-FVDS

VERDE ÁGUA

CÓD. BARRA: 7908221603358



REF.: AC0006-FVD

VERDE

CÓD. BARRA: 7908221603419



REF.: AC0006-FVS

VERDE CLARO

CÓD. BARRA: 7908221603402



REF.: AC0006-FMR

MARROM

CÓD. BARRA: 7908221603259



REF.: AC0006-FP

PRETO

CÓD. BARRA: 7908221603235



REF.: AC0006-FCZ

CINZA

CÓD. BARRA: 7908221687020



TIARA FORRADA



REF.: AC0006-FIRIS

TIARA FORRADA CETIM 1X12

COR: ÍRIS

CÓDIGO DE BARRA: 7908221603426

FRAÇÃO PACOTE C/ 12 UNID

R\$ 7,80

PREÇO PACOTE



REF.: AC0005-FGO

TIARA FORRADA CETIM 1X50

COR: MOSTARDA

CÓDIGO DE BARRA: 7908221608230

NCM: 9615.11.00 IPI:9,75%

FRAÇÃO PACOTE C/ 50 UNID

R\$ 20,00

PREÇO PACOTE



REF.: AC0005-FVD

TIARA FORRADA CETIM 1X50 -

COR: VERDE

CÓDIGO DE BARRA: 7908221608186

NCM: 9615.11.00 IPI: 9,75%

FRAÇÃO PACOTE C/ 50 UNID

R\$ 20,00

PREÇO PACOTE



REF.: AC0005-FCR

TIARA FORRADA CETIM 1X50 -

COR: CREME

CÓDIGO DE BARRA: 4227677700057

NCM: 9615.11.00 IPI: 9,75%

FRAÇÃO PACOTE C/ 50 UNID

R\$ 20,00

PREÇO PACOTE



REF.: AC0005-FRX

TIARA FORRADA CETIM 1X50 -

COR: ROXO

CÓDIGO DE BARRA: 4933306800059

NCM: 9615.11.00 IPI: 9,75%

FRAÇÃO PACOTE C/ 50 UNID

R\$ 20,00

PREÇO PACOTE

TIARAS DIVERSAS

TIARA REVESTIDA DE GORGURÃO

NCM: 9505.90.00 IPI: 13%



REF.: AC0007-GVD

COR: VERDE

CÓDIGO DE BARRA: 7908221603549

FRAÇÃO PACOTE C/ 12 UNID

R\$ 8,90

PREÇO PACOTE

FRAÇÃO PACOTE C/ 50 UNID

R\$ 32,50

PREÇO PACOTE



REF.: AC0007-GAO

AMARELO

CÓDIGO DE BARRA: 7908221603532

FRAÇÃO PACOTE C/ 12 UNID

R\$ 8,90

PREÇO PACOTE

FRAÇÃO PACOTE C/ 50 UNID

R\$ 32,50

PREÇO PACOTE



REF.: AC0007-GVM

VERMELHO

CÓDIGO DE BARRA: 7908221603488

FRAÇÃO PACOTE C/ 12 UNID

R\$ 8,90

PREÇO PACOTE

FRAÇÃO PACOTE C/ 50 UNID

R\$ 32,50

PREÇO PACOTE



REF.: AC0007-GLJ

LARANJA

CÓDIGO DE BARRA: 7908221603532

FRAÇÃO PACOTE C/ 12 UNID

R\$ 8,90

PREÇO PACOTE

FRAÇÃO PACOTE C/ 50 UNID

R\$ 32,50

PREÇO PACOTE



REF.: AC0007-GAT

AZUL

CÓDIGO DE BARRA: 7908221603525

FRAÇÃO PACOTE C/ 12 UNID

ESGOTADO

PREÇO PACOTE

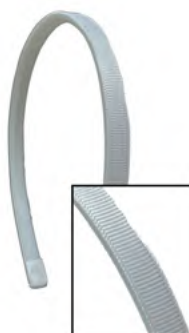

REF.: AC0007-GBR

BRANCO

CÓDIGO DE BARRA: 7908221603587

FRAÇÃO PACOTE C/ 50 UNID

R\$ 32,50

PREÇO PACOTE



REF.: AC0007-GOW

OFF-WHITE

CÓDIGO DE BARRA: 7908221681745

FRAÇÃO PACOTE C/ 50 UNID

R\$ 32,50

PREÇO PACOTE



REF.: AC0007-GGE

GELO

CÓDIGO DE BARRA: 7908221681776

FRAÇÃO PACOTE C/ 50 UNID

R\$ 32,50

PREÇO PACOTE

TIARAS DIVERSAS



REF.: AC0007-GCZ

CINZA

CÓDIGO DE BARRA: 7908221681738

FRAÇÃO PACOTE C/ 50 UNID

R\$ 32,50

PREÇO PACOTE



REF.: AC0007-GP

PRETO

CÓDIGO DE BARRA: 7908221603495

FRAÇÃO PACOTE C/ 50 UNID

R\$ 32,50

PREÇO PACOTE



REF.: AC0007-GRX

ROXO CLARO

CÓDIGO DE BARRA: 7908221603563

FRAÇÃO PACOTE C/ 50 UNID

R\$ 32,50

PREÇO PACOTE



REF.: AC0007-GRB

ROSA BEBÊ

CÓDIGO DE BARRA: 7908221603501

FRAÇÃO PACOTE C/ 50 UNID

R\$ 32,50

PREÇO PACOTE



REF.: AC0007-GPK

PINK

CÓDIGO DE BARRA: 7908221603518

FRAÇÃO PACOTE C/ 50 UNID

R\$ 32,50

PREÇO PACOTE



REF.: AC0007-GSM

SALMÃO

CÓDIGO DE BARRA: 7908221681752

FRAÇÃO PACOTE C/ 50 UNID

R\$ 32,50

PREÇO PACOTE



REF.: AC0007-GAZ

AZUL ROYAL

CÓDIGO DE BARRA: 7908221681783

FRAÇÃO PACOTE C/ 50 UNID

R\$ 32,50

PREÇO PACOTE



REF.: AC0007-GAB

AZUL CLARO

CÓDIGO DE BARRA: 7908221603600

FRAÇÃO PACOTE C/ 50 UNID

R\$ 32,50

PREÇO PACOTE



REF.: AC0007-GVDS

VERDE ÁGUA

CÓDIGO DE BARRA: 7908221603594

FRAÇÃO PACOTE C/ 50 UNID

R\$ 32,50

PREÇO PACOTE



REF.: AC0007-GMC

MARROM CLARO

CÓDIGO DE BARRA: 7908221681769

FRAÇÃO PACOTE C/ 50 UNID

R\$ 32,50

PREÇO PACOTE



TIARAS DIVERSAS



REF.: AC0005-TP-F

TIARA FINA DE METAL PRATA - 5MM

CÓDIGO DE BARRA: 7908221608308

NCM: 9505.90.00 IPI: 13%

FRAÇÃO PACOTE C/ 12 UNID

R\$ 5,25

PREÇO PACOTE



REF.: AC0005-TG-F

TIARA FINA DE METAL DOURADO - 5MM

CÓDIGO DE BARRA: 7908221649042

NCM: 9505.90.00 IPI: 13%

FRAÇÃO PACOTE C/ 12 UNID

R\$ 5,25

PREÇO PACOTE

ABRAÇADEIRAS

ABRAÇADEIRA DE PLÁSTICO

PACOTE COM 100 UNIDADES

NCM: 3926.90.90 IPI: 9,75%



REF.: UT0031-30-3

3 mm X 300 mm

CÓDIGO DE BARRA: 7908221684272

REF.: ESGOTADO

3,5 mm X 150 mm

CÓDIGO DE BARRA: 7908221684289

REF.: UT0031-25-3,5

3,5 mm X 250 mm

CÓDIGO DE BARRA: 7908221684302

REF.: UT0031-20-4

4 mm X 200 mm

CÓDIGO DE BARRA: 7908221684296

REF.: UT0031-25-4

4 mm X 250 mm

CÓDIGO DE BARRA: 7908221684258

REF.: UT0031-15-4,5

4,5 mm X 150 mm

CÓDIGO DE BARRA: 7908221684241

REF.: UT0031-25-4,5

4,5 mm X 250 mm

CÓDIGO DE BARRA: 7908221684265

REF.: UT0031-30-5

5 mm X 300 mm

CÓDIGO DE BARRA: 7908221684319

R\$ 4,85

PREÇO PACOTE

ESGOTADO

PREÇO PACOTE

R\$ 4,70

PREÇO PACOTE

R\$ 3,95

PREÇO PACOTE

R\$ 5,05

PREÇO PACOTE

R\$ 4,60

PREÇO PACOTE

R\$ 6,90

PREÇO PACOTE

R\$ 8,45

PREÇO PACOTE

ABRAÇADEIRA DE PLÁSTICO COLORIDO 5 mm X 300 mm

PACOTE COM 100 UNIDADES

NCM: 3926.90.90 IPI: 9,75%



REF.: UT0035-B

AZUL

CÓDIGO DE BARRA: 7908221684340

REF.: UT0035-Y

AMARELO

CÓDIGO DE BARRA: 7908221684364

REF.: UT0035-R

VERMELHO

CÓDIGO DE BARRA: 7908221684371

REF.: UT0035-P

PINK

CÓDIGO DE BARRA: 7908221684333

REF.: UT0035-GR

VERDE

CÓDIGO DE BARRA: 7908221684326

REF.: UT0035-O

LARANJA

CÓDIGO DE BARRA: 7908221684357

R\$ 8,95

PREÇO PACOTE



CHAVEIROS, ARGOLAS E FECHOS

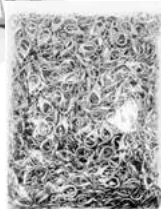

MODO DE EMBALAGEM



MODO DE EMBALAGEM



1.2 CM

REF.: AR2024-65

FECHO PARA CHAVEIRO 1.2CM - 1000PCS - PRATA
CÓDIGO DE BARRA: 7908221654497
NCM: 73269090 IPI: 5,0%

FRAÇÃO 1000 UND

R\$ 54,00

PREÇO PACOTE



1.2 CM

REF.: AR2024-70

FECHO PARA CHAVEIRO 1.2CM - 1000PCS - DOURADO
CÓDIGO DE BARRA: 7908221654541
NCM: 73269090 IPI: 5,0%

FRAÇÃO 1000 UND

R\$ 54,00

PREÇO PACOTE



1.4 CM

REF.: AR2024-66

FECHO PARA CHAVEIRO 1.4CM - 1000PCS - PRATA
CÓDIGO DE BARRA: 7908221654503
NCM: 73269090 IPI: 5,0%

FRAÇÃO 1000 UND

R\$ 75,00

PREÇO PACOTE



1.4 CM

REF.: AR2024-71

FECHO PARA CHAVEIRO 1.4CM - 1000PCS - DOURADO
CÓDIGO DE BARRA: 7908221654558
NCM: 73269090 IPI: 5,0%

FRAÇÃO 1000 UND

R\$ 75,00

PREÇO PACOTE



1,6 CM

REF.: AR2024-67

FECHO PARA CHAVEIRO 1.6CM - 1000PCS - PRATA
CÓDIGO DE BARRA: 7908221654510
NCM: 73269090 IPI: 5,0%

FRAÇÃO 1000 UND

R\$ 97,00

PREÇO PACOTE



1,6 CM

REF.: AR2024-72

FECHO PARA CHAVEIRO 1.6CM - 1000PCS - DOURADO
CÓDIGO DE BARRA: 7908221654565
NCM: 73269090 IPI: 5,0%

FRAÇÃO 1000 UND

R\$ 97,00

PREÇO PACOTE



1,8 CM

REF.: AR2024-68

FECHO PARA CHAVEIRO 1.8CM - 1000PCS - PRATA
CÓDIGO DE BARRA: 7908221654527
NCM: 73269090 IPI: 5,0%

FRAÇÃO 1000 UND

R\$ 120,00

PREÇO PACOTE



1,8 CM

REF.: AR2024-73

FECHO PARA CHAVEIRO 1.8CM - 1000PCS - DOURADO
CÓDIGO DE BARRA: 7908221654578
NCM: 73269090 IPI: 5,0%

FRAÇÃO 1000 UND

R\$ 120,00

PREÇO PACOTE



2,1 CM

REF.: AR2024-69

FECHO PARA CHAVEIRO 2.1CM - 1000PCS - PRATA
CÓDIGO DE BARRA: 7908221654534
NCM: 73269090 IPI: 5,0%

FRAÇÃO 1000 UND

R\$ 140,00

PREÇO PACOTE



2,1 CM

REF.: AR2024-74

FECHO PARA CHAVEIRO 2.1CM - 1000PCS - DOURADO
CÓDIGO DE BARRA: 7908221654589
NCM: 73269090 IPI: 5,0%

FRAÇÃO 1000 UND

R\$ 140,00

PREÇO PACOTE

CHAVEIROS, ARGOLAS E FECHOS



REF.: AR2024-61

FECHO PARA CHAVEIRO PRATA - 3.8*2CM - 500PCS

CÓDIGO DE BARRA: 7908221654459

NCM: 73269090 IPI: 5,0%

FRAÇÃO PACOTE C/ 500 UND

R\$ 295,00

PREÇO PACOTE



REF.: AR2024-62

FECHO P/ CHAVEIRO DOURADO - 3.8*2CM - 500PCS

CÓDIGO DE BARRA: 7908221654466

NCM: 73269090 IPI: 5,0%

FRAÇÃO PACOTE C/ 500 UND

R\$ 308,00

PREÇO PACOTE



REF.: AR2024-56

FECHO PARA CHAVEIRO PRATA - 3.3CM - 500PCS

CÓDIGO DE BARRA: 7908221654404

NCM: 73269090 IPI: 5%

FRAÇÃO PACOTE

R\$ 315,00

PREÇO PACOTE



REF.: AR2024-55

FECHO PARA CHAVEIRO DOURADO - 3.3CM - 500PCS

CÓDIGO DE BARRA: 7908221654398

NCM: 73269090 IPI: 5%

FRAÇÃO PACOTE

R\$ 315,00

PREÇO PACOTE



REF.: AR2024-59

FECHO PARA CHAVEIRO PRATA - 4*3CM - 500PCS

CÓDIGO DE BARRA: 7908221654435

NCM: 73269090 IPI: 5,0%

FRAÇÃO PACOTE C/ 500 UND

R\$ 289,00

PREÇO PACOTE



REF.: AR2024-60

FECHO P/ CHAVEIRO DOURADO - 4*3CM - 500PCS

CÓDIGO DE BARRA: 7908221654442

NCM: 73269090 IPI: 5,0%

FRAÇÃO PACOTE C/ 500 UND

R\$ 312,00

PREÇO PACOTE



REF.: AR2024-58

FECHO PARA CHAVEIRO PRATA - 3.6 CM - 500PCS

CÓDIGO DE BARRA: 7908221654428

NCM: 73269090 IPI: 5%

FRAÇÃO PACOTE C/ 500 UND

R\$ 235,00

PREÇO PACOTE



REF.: AR2024-57

FECHO PARA CHAVEIRO DOURADO - 3.6CM - 500PCS

CÓDIGO DE BARRA: 7908221654411

NCM: 73269090 IPI: 5%

FRAÇÃO PACOTE C/ 500 UND

R\$ 235,00

PREÇO PACOTE



REF.: AR2024-63

FECHO PARA CHAVEIRO PRATA - 2.8 CM - 500PCS

CÓDIGO DE BARRA: 7908221654473

NCM: 73269090 IPI: 5%

FRAÇÃO PACOTE C/ 500 UND

R\$ 330,00

PREÇO PACOTE



REF.: AR2024-64

FECHO P/ CHAVEIRO DOURADO - 2.8 CM - 500PCS

CÓDIGO DE BARRA: 7908221654480

NCM: 73269090 IPI: 5%

FRAÇÃO PACOTE C/ 500 UND

R\$ 350,00

PREÇO PACOTE



REF.: AR2024-96

FECHO PARA CHAVEIRO DOURADO - 3.4*1.5 CM - 500 PCS

CÓDIGO DE BARRA: 7908221654664

NCM: 73269090 IPI: 5%

FRAÇÃO PACOTE C/ 500 UND

R\$ 330,00

PREÇO PACOTE



REF.: AR2024-96

FECHO PARA CHAVEIRO PRATA - 3.4*1.5 CM - 500 PCS

CÓDIGO DE BARRA: 7908221654671

NCM: 73269090 IPI: 5%

FRAÇÃO PACOTE C/ 500 UND

R\$ 330,00

PREÇO PACOTE

CHAVEIROS, ARGOLAS E FECHOS



REF.: AC0111-1

ACESSÓRIO TIPO ALÇA CHAVEIRO MOD 1

CÓDIGO DE BARRA: 7908221624810

NCM: 7326.90.90 IPI: 5%

FRAÇÃO 50 UNID

R\$ 1,90

PREÇO UNITÁRIO



REF.: AC0111-2

ACESSÓRIO TIPO ALÇA CHAVEIRO MOD 2

CÓDIGO DE BARRA: 7908221624827

NCM: 7326.90.90 IPI: 5%

FRAÇÃO 50 UNID

R\$ 1,90

PREÇO UNITÁRIO



REF.: AC0111-3

ACESSÓRIO TIPO ALÇA CHAVEIRO MOD 3

CÓDIGO DE BARRA: 7908221624834

NCM: 7326.90.90 IPI: 5%

FRAÇÃO 50 UNID

R\$ 1,90

PREÇO UNITÁRIO



REF.: AC0111-4

ACESSÓRIO TIPO ALÇA CHAVEIRO MOD 4

CÓDIGO DE BARRA: 7908221624841

NCM: 7326.90.90 IPI: 5%

FRAÇÃO 50 UNID

R\$ 1,90

PREÇO UNITÁRIO



REF.: AC0111-5

ACESSÓRIO TIPO ALÇA CHAVEIRO MOD 5

CÓDIGO DE BARRA: 7908221624858

NCM: 7326.90.90 IPI: 5%

FRAÇÃO 50 UNID

R\$ 1,90

PREÇO UNITÁRIO



REF.: AC0111-6

ACESSÓRIO TIPO ALÇA CHAVEIRO MOD 6

CÓDIGO DE BARRA: 7908221624865

NCM: 7326.90.90 IPI: 5%

FRAÇÃO 50 UNID

R\$ 1,90

PREÇO UNITÁRIO

CHAVEIROS, ARGOLAS E FECHOS



REF.: AR0006-1

CHAVEIRO MOSQUETÃO PRETO 2,5CM

CÓDIGO DE BARRA: 7908221648830

NCM: 7326.90.90 IPI: 5%

CX MASTER 10 PCT

FRAÇÃO PCT C/ 500 UNID

R\$ 0,30

PREÇO UNIDADE

R\$ 0,35

PREÇO UNIDADE



REF.: AR0006-2

CHAVEIRO MOSQUETÃO BRANCO 2,5CM

CÓDIGO DE BARRA: 7908221648847

NCM: 7326.90.90 IPI: 5%

CX MASTER 10 PCT

FRAÇÃO PCT C/ 500 UNID

R\$ 0,30

PREÇO UNIDADE

R\$ 0,35

PREÇO UNIDADE



REF.:AR0006-3

CHAVEIRO MOSQUETÃO 2,5CM - MIX COR

CÓDIGO DE BARRA: 7908221648854

NCM: 7326.90.90 IPI: 5%

CX MASTER 10 PCT

FRAÇÃO PCT C/ 500 UNID

R\$ 0,30

PREÇO UNIDADE

R\$ 0,35

PREÇO UNIDADE



REF.: AR0007-1

CHAVEIRO MOSQUETÃO PRETO 3,5CM

CÓDIGO DE BARRA: 7908221648809

NCM: 7326.90.90 IPI: 5%

CX MASTER 10 PCT

FRAÇÃO PCT C/ 500 UNID

R\$ 0,25

PREÇO UNIDADE

R\$ 0,30

PREÇO UNIDADE



REF.:AR0007-2

CHAVEIRO MOSQUETÃO BRANCO 3,5CM

CÓDIGO DE BARRA: 7908221648816

NCM: 7326.90.90 IPI: 5%

CX MASTER 10 PCT

FRAÇÃO PCT C/ 500 UNID

R\$ 0,25

PREÇO UNIDADE

R\$ 0,30

PREÇO UNIDADE



REF.:AR0007-3

CHAVEIRO MOSQUETÃO 3,5CM - MIX COR

CÓDIGO DE BARRA: 7908221648823

NCM: 7326.90.90 IPI: 5%

CX MASTER 10 PCT

FRAÇÃO PCT C/ 500 UNID

R\$ 0,25

PREÇO UNIDADE

R\$ 0,30

PREÇO UNIDADE



REF.: AR2024-54

FECHO PARA CHAVEIRO - 3.4CM - 500PCS

CÓDIGO DE BARRA: 7908221654381

NCM: 73269090 IPI: 5,0%

FRAÇÃO PACOTE C/ 500 UND

R\$ 289,00

PREÇO PACOTE

SIANINHAS



3 mm

REF.: AR0184-4

SIANINHA 3 mm - 20 m

CÓD.BARRA: 7908221668289

NCM: 58089000 IPI: 0%

FRAÇÃO 12 UND

R\$ 7,80

PREÇO UNIDADE

OUTRAS CORES:



REF.: AR0184-1

SIANINHA 3 mm - 20 m

CÓD.BARRA: 7908221668258

NCM: 58089000 IPI: 0%



REF.: AR0184-5

SIANINHA 3 mm - 20 m

CÓD.BARRA: 7908221668296

NCM: 58089000 IPI: 0%



REF.: AR0184-7

SIANINHA 3 mm - 20 m

CÓD.BARRA: 7908221668319

NCM: 58089000 IPI: 0%



REF.: AR0184-6

SIANINHA 3 mm - 20 m

CÓD.BARRA: 7908221668302

NCM: 58089000 IPI: 0%



REF.: AR0184-8

SIANINHA 3 mm - 20 m

CÓD.BARRA: 7908221668326

NCM: 58089000 IPI: 0%



REF.: AR0184-3

SIANINHA 3 mm - 20 m

CÓD.BARRA: 7908221668272

NCM: 58089000 IPI: 0%



REF.: AR0184-16

SIANINHA 3 mm - 20 m

CÓD.BARRA: 7908221668401

NCM: 58089000 IPI: 0%



REF.: AR0184-13

SIANINHA 3 mm - 20 m

CÓD.BARRA: 7908221668371

NCM: 58089000 IPI: 0%



REF.: AR0184-17

SIANINHA 3 mm - 20 m

CÓD.BARRA: 7908221668418

NCM: 58089000 IPI: 0%



REF.: AR0184-18

SIANINHA 3 mm - 20 m

CÓD.BARRA: 7908221668425

NCM: 58089000 IPI: 0%



REF.: AR0184-2

SIANINHA 3 mm - 20 m

CÓD.BARRA: 7908221668265

NCM: 58089000 IPI: 0%



REF.: AR0184-15

SIANINHA 3 mm - 20 m

CÓD.BARRA: 7908221668395

NCM: 58089000 IPI: 0%



REF.: AR0184-14

SIANINHA 3 mm - 20 m

CÓD.BARRA: 7908221668388

NCM: 58089000 IPI: 0%



REF.: AR0184-19

SIANINHA 3 mm - 20 m

CÓD.BARRA: 7908221668432

NCM: 58089000 IPI: 0%



REF.: AR0184-11

SIANINHA 3 mm - 20 m

CÓD.BARRA: 7908221668357

NCM: 58089000 IPI: 0%



REF.: AR0184-12

SIANINHA 3 mm - 20 m

CÓD.BARRA: 7908221668364

NCM: 58089000 IPI: 0%



REF.: AR0184-10

SIANINHA 3 mm - 20 m

CÓD.BARRA: 7908221668340

NCM: 58089000 IPI: 0%



REF.: AR0184-9

SIANINHA 3 mm - 20 m

CÓD.BARRA: 7908221668333

NCM: 58089000 IPI: 0%

SIANINHAS



5 mm 

REF.: AR0182-4

SIANINHA 5 mm - 20 m
CÓD.BARRA: 7908221668470
NCM: 58089000 IPI: 0%
FRAÇÃO 12 UND

R\$ 8,30
PREÇO UNIDADE

OUTRAS CORES:



REF.: AR0182-2

SIANINHA 5 mm - 20 m
CÓD.BARRA: 7908221668456
NCM: 58089000 IPI: 0%



REF.: AR0182-3

SIANINHA 5 mm - 20 m
CÓD.BARRA: 7908221668463
NCM: 58089000 IPI: 0%



REF.: AR0182-1

SIANINHA 5 mm - 20 m
CÓD.BARRA: 7908221668449
NCM: 58089000 IPI: 0%



REF.: AR0182-5

SIANINHA 5 mm - 20 m
CÓD.BARRA: 7908221668487
NCM: 58089000 IPI: 0%



REF.: AR0182-6

SIANINHA 5 mm - 20 m
CÓD.BARRA: 7908221668494
NCM: 58089000 IPI: 0%



REF.: AR0182-7

SIANINHA 5 mm - 20 m
CÓD.BARRA: 7908221668500
NCM: 58089000 IPI: 0%



REF.: AR0182-8

SIANINHA 5 mm - 20 m
CÓD.BARRA: 7908221668517
NCM: 58089000 IPI: 0%



REF.: AR0182-9

SIANINHA 5 mm - 20 m
CÓD.BARRA: 7908221668524
NCM: 58089000 IPI: 0%



REF.: AR0182-10

SIANINHA 5 mm - 20 m
CÓD.BARRA: 7908221668531
NCM: 58089000 IPI: 0%



REF.: AR0182-11

SIANINHA 5 mm - 20 m
CÓD.BARRA: 7908221668548
NCM: 58089000 IPI: 0%



REF.: AR0182-12

SIANINHA 5 mm - 20 m
CÓD.BARRA: 7908221668555
NCM: 58089000 IPI: 0%



REF.: AR0182-13

SIANINHA 5 mm - 20 m
CÓD.BARRA: 7908221668562
NCM: 58089000 IPI: 0%



REF.: AR0182-14

SIANINHA 5 mm - 20 m
CÓD.BARRA: 7908221668579
NCM: 58089000 IPI: 0%



REF.: AR0182-15

SIANINHA 5 mm - 20 m
CÓD.BARRA: 7908221668586
NCM: 58089000 IPI: 0%



REF.: AR0182-16

SIANINHA 5 mm - 20 m
CÓD.BARRA: 7908221668593
NCM: 58089000 IPI: 0%



REF.: AR0182-17

SIANINHA 5 mm - 20 m
CÓD.BARRA: 7908221668609
NCM: 58089000 IPI: 0%



REF.: AR0182-18

SIANINHA 5 mm - 20 m
CÓD.BARRA: 7908221668616
NCM: 58089000 IPI: 0%



REF.: AR0182-19

SIANINHA 5 mm - 20 m
CÓD.BARRA: 7908221668623
NCM: 58089000 IPI: 0%

SIANINHAS



8 mm 

REF.: AR0183-1

SIANINHA 8 mm - 20 m

CÓD.BARRA: 7908221668630

NCM: 58089000 IPI: 0%

FRAÇÃO 12 UND

R\$ 14,25

PREÇO UNIDADE

OUTRAS CORES:



REF.: AR0183-2

SIANINHA 8 mm - 20 m

CÓD.BARRA: 7908221668647

NCM: 58089000 IPI: 0%



REF.: AR0183-3

SIANINHA 8 mm - 20 m

CÓD.BARRA: 7908221668654

NCM: 58089000 IPI: 0%



REF.: AR0183-4

SIANINHA 8 mm - 20 m

CÓD.BARRA: 7908221668661

NCM: 58089000 IPI: 0%



REF.: AR0183-5

SIANINHA 8 mm - 20 m

CÓD.BARRA: 7908221668678

NCM: 58089000 IPI: 0%



REF.: AR0183-6

SIANINHA 8 mm - 20 m

CÓD.BARRA: 7908221668685

NCM: 58089000 IPI: 0%



REF.: AR0183-7

SIANINHA 8 mm - 20 m

CÓD.BARRA: 7908221668692

NCM: 58089000 IPI: 0%



REF.: AR0183-8

SIANINHA 8 mm - 20 m

CÓD.BARRA: 7908221668708

NCM: 58089000 IPI: 0%



REF.: AR0183-9

SIANINHA 8 mm - 20 m

CÓD.BARRA: 7908221668715

NCM: 58089000 IPI: 0%



REF.: AR0183-10

SIANINHA 8 mm - 20 m

CÓD.BARRA: 7908221668722

NCM: 58089000 IPI: 0%



REF.: AR0183-11

SIANINHA 8 mm - 20 m

CÓD.BARRA: 7908221668739

NCM: 58089000 IPI: 0%



REF.: AR0183-12

SIANINHA 8 mm - 20 m

CÓD.BARRA: 7908221668746

NCM: 58089000 IPI: 0%



REF.: AR0183-13

SIANINHA 8 mm - 20 m

CÓD.BARRA: 7908221668753

NCM: 58089000 IPI: 0%



REF.: AR0183-14

SIANINHA 8 mm - 20 m

CÓD.BARRA: 7908221668760

NCM: 58089000 IPI: 0%



REF.: AR0183-15

SIANINHA 8 mm - 20 m

CÓD.BARRA: 7908221668777

NCM: 58089000 IPI: 0%



REF.: AR0183-16

SIANINHA 8 mm - 20 m

CÓD.BARRA: 7908221668784

NCM: 58089000 IPI: 0%



REF.: AR0183-17

SIANINHA 8 mm - 20 m

CÓD.BARRA: 7908221668791

NCM: 58089000 IPI: 0%



REF.: AR0183-18

SIANINHA 8 mm - 20 m

CÓD.BARRA: 7908221668807

NCM: 58089000 IPI: 0%



REF.: AR0183-19

SIANINHA 8 mm - 20 m

CÓD.BARRA: 7908221668814

NCM: 58089000 IPI: 0%

CORDÃO SÃO FRANCISCO

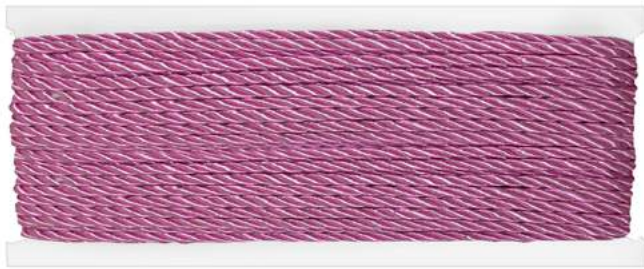

3 mm

REF.: AR0200-3

CORDÃO SÃO FRANCISCO 3 mm - 20 m

CÓD.BARRA: 7908221668845

NCM: 58089000 IPI: 0%

FRAÇÃO 12 UND

R\$ 10,15

PREÇO UNIDADE

OUTRAS CORES:



REF.: AR0200-4

CORDÃO SÃO FRANCISCO 3 mm - 20 m

CÓD.BARRA: 7908221668852

NCM: 58089000 IPI: 0%



REF.: AR0200-5

CORDÃO SÃO FRANCISCO 3 mm - 20 m

CÓD.BARRA: 7908221668869

NCM: 58089000 IPI: 0%



REF.: AR0200-6

CORDÃO SÃO FRANCISCO 3 mm - 20 m

CÓD.BARRA: 7908221668876

NCM: 58089000 IPI: 0%



REF.: AR0200-7

CORDÃO SÃO FRANCISCO 3 mm - 20 m

CÓD.BARRA: 7908221668883

NCM: 58089000 IPI: 0%



REF.: AR0200-8

CORDÃO SÃO FRANCISCO 3 mm - 20 m

CÓD.BARRA: 7908221668890

NCM: 58089000 IPI: 0%

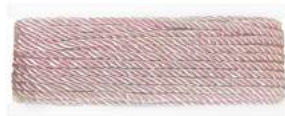

REF.: AR0200-9

CORDÃO SÃO FRANCISCO 3 mm - 20 m

CÓD.BARRA: 7908221668906

NCM: 58089000 IPI: 0%



REF.: AR0200-10

CORDÃO SÃO FRANCISCO 3 mm - 20 m

CÓD.BARRA: 7908221668913

NCM: 58089000 IPI: 0%



REF.: AR0200-11

CORDÃO SÃO FRANCISCO 3 mm - 20 m

CÓD.BARRA: 7908221668920

NCM: 58089000 IPI: 0%



REF.: AR0200-12

CORDÃO SÃO FRANCISCO 3 mm - 20 m

CÓD.BARRA: 7908221668937

NCM: 58089000 IPI: 0%



REF.: AR0200-13

CORDÃO SÃO FRANCISCO 3 mm - 20 m

CÓD.BARRA: 7908221668944

NCM: 58089000 IPI: 0%



REF.: AR0200-14

CORDÃO SÃO FRANCISCO 3 mm - 20 m

CÓD.BARRA: 7908221668951

NCM: 58089000 IPI: 0%



REF.: AR0200-15

CORDÃO SÃO FRANCISCO 3 mm - 20 m

CÓD.BARRA: 7908221668968

NCM: 58089000 IPI: 0%



REF.: AR0200-16

CORDÃO SÃO FRANCISCO 3 mm - 20 m

CÓD.BARRA: 7908221668975

NCM: 58089000 IPI: 0%



REF.: AR0200-17

CORDÃO SÃO FRANCISCO 3 mm - 20 m

CÓD.BARRA: 7908221668982

NCM: 58089000 IPI: 0%



REF.: AR0200-18

CORDÃO SÃO FRANCISCO 3 mm - 20 m

CÓD.BARRA: 7908221668999

NCM: 58089000 IPI: 0%



REF.: AR0200-19

CORDÃO SÃO FRANCISCO 5 mm - 10 m

CÓD.BARRA: 7908221669002

NCM: 58089000 IPI: 0%



REF.: AR0200-20

CORDÃO SÃO FRANCISCO 3 mm - 20 m

CÓD.BARRA: 7908221669019

NCM: 58089000 IPI: 0%



REF.: AR0200-21

CORDÃO SÃO FRANCISCO 3 mm - 20 m

CÓD.BARRA: 7908221669026

NCM: 58089000 IPI: 0%

CORDÃO SÃO FRANCISCO

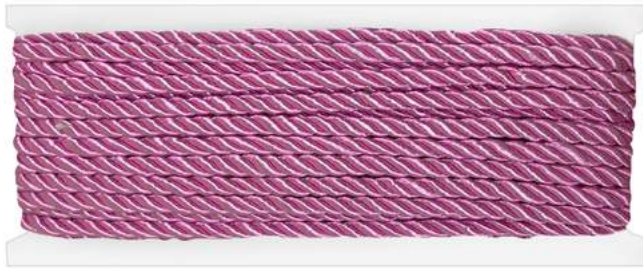

5 mm

REF.: AR0201-3

CORDÃO SÃO FRANCISCO 5 mm - 10 m

CÓD.BARRA: 7908221669057

NCM: 58089000 IPI: 0%

FRAÇÃO 12 UND

R\$ 7,15

PREÇO UNIDADE

OUTRAS CORES:



REF.: AR0201-4

CORDÃO SÃO FRANCISCO 5 mm - 10 m

CÓD.BARRA: 7908221669064

NCM: 58089000 IPI: 0%



REF.: AR0201-5

CORDÃO SÃO FRANCISCO 5 mm - 10 m

CÓD.BARRA: 7908221669071

NCM: 58089000 IPI: 0%



REF.: AR0201-6

CORDÃO SÃO FRANCISCO 5 mm - 10 m

CÓD.BARRA: 7908221669088

NCM: 58089000 IPI: 0%



REF.: AR0201-7

CORDÃO SÃO FRANCISCO 5 mm - 10 m

CÓD.BARRA: 7908221669095

NCM: 58089000 IPI: 0%



REF.: AR0201-8

CORDÃO SÃO FRANCISCO 5 mm - 10 m

CÓD.BARRA: 7908221669101

NCM: 58089000 IPI: 0%



REF.: AR0201-9

CORDÃO SÃO FRANCISCO 5 mm - 10 m

CÓD.BARRA: 7908221669118

NCM: 58089000 IPI: 0%



REF.: AR0201-10

CORDÃO SÃO FRANCISCO 5 mm - 10 m

CÓD.BARRA: 7908221669125

NCM: 58089000 IPI: 0%



REF.: AR0201-11

CORDÃO SÃO FRANCISCO 5 mm - 10 m

CÓD.BARRA: 7908221669132

NCM: 58089000 IPI: 0%



REF.: AR0201-12

CORDÃO SÃO FRANCISCO 5 mm - 10 m

CÓD.BARRA: 7908221669149

NCM: 58089000 IPI: 0%



REF.: AR0201-13

CORDÃO SÃO FRANCISCO 5 mm - 10 m

CÓD.BARRA: 7908221669156

NCM: 58089000 IPI: 0%



REF.: AR0201-14

CORDÃO SÃO FRANCISCO 5 mm - 10 m

CÓD.BARRA: 7908221669163

NCM: 58089000 IPI: 0%



REF.: AR0201-15

CORDÃO SÃO FRANCISCO 5 mm - 10 m

CÓD.BARRA: 7908221669170

NCM: 58089000 IPI: 0%



REF.: AR0201-16

CORDÃO SÃO FRANCISCO 5 mm - 10 m

CÓD.BARRA: 7908221669187

NCM: 58089000 IPI: 0%



REF.: AR0201-17

CORDÃO SÃO FRANCISCO 5 mm - 10 m

CÓD.BARRA: 7908221669194

NCM: 58089000 IPI: 0%



REF.: AR0201-18

CORDÃO SÃO FRANCISCO 5 mm - 10 m

CÓD.BARRA: 7908221669200

NCM: 58089000 IPI: 0%



REF.: AR0201-19

CORDÃO SÃO FRANCISCO 5 mm - 10 m

CÓD.BARRA: 7908221669217

NCM: 58089000 IPI: 0%



REF.: AR0201-20

CORDÃO SÃO FRANCISCO 5 mm - 10 m

CÓD.BARRA: 7908221669224

NCM: 58089000 IPI: 0%



REF.: AR0201-21

CORDÃO SÃO FRANCISCO 5 mm - 10 m

CÓD.BARRA: 7908221669231

NCM: 58089000 IPI: 0%

CORDÃO SÃO FRANCISCO



 **3 mm**

REF.: AR0200-1

CORDÃO SÃO FRANCISCO 3 mm - 20 m

CÓD.BARRA: 7908221668821

NCM: 58089000 IPI: 0%

FRAÇÃO 12 UND

R\$ 16,65

PREÇO UNIDADE

 **5 mm**

REF.: AR0201-1

CORDÃO SÃO FRANCISCO 5 mm - 10 m

CÓD.BARRA: 7908221669033

NCM: 58089000 IPI: 0%

FRAÇÃO 12 UND

R\$ 11,90

PREÇO UNIDADE



 **3 mm**

REF.: AR0200-2

CORDÃO SÃO FRANCISCO 3 mm - 20 m

CÓD.BARRA: 7908221668838

NCM: 58089000 IPI: 0%

FRAÇÃO 12 UND

R\$ 16,65

PREÇO UNIDADE

 **5 mm**

REF.: AR0201-2

CORDÃO SÃO FRANCISCO 5 mm - 10 m

CÓD.BARRA: 7908221669040

NCM: 58089000 IPI: 0%

FRAÇÃO 12 UND

R\$ 11,90

PREÇO UNIDADE

PINGENTES

2 cm



REF.: AR0993-1

PINGENTE DECORATIVO 2CM - 100PCS

CÓD.DE BARRA: 7908221656514

NCM: 58089000 IPI: 0%

FRAÇÃO PACOTE

R\$ 24,90

PREÇO PACOTE



MODO DE EMBALAGEM



REF.: AR0993-23

PINGENTE DECORATIVO 2CM - 100PCS

CÓD. DE BARRA: 7908221656675

NCM: 58089000 IPI: 0%



REF.: AR0993-36

PINGENTE DECORATIVO 2CM - 100PCS

CÓD. DE BARRA: 7908221656729

NCM: 58089000 IPI: 0%



REF.: AR0993-26

PINGENTE DECORATIVO 2CM - 100PCS

CÓD. DE BARRA: 7908221656682

NCM: 58089000 IPI: 0%



REF.: AR0993-6

PINGENTE DECORATIVO 2CM - 100PCS

CÓD. DE BARRA: 7908221656552

NCM: 58089000 IPI: 0%



REF.: AR0993-7

PINGENTE DECORATIVO 2CM - 100PCS

CÓD. DE BARRA: 7908221656569

NCM: 58089000 IPI: 0%



REF.: AR0993-1

PINGENTE DECORATIVO 2CM - 100PCS

CÓD. DE BARRA: 7908221656514

NCM: 58089000 IPI: 0%



REF.: AR0993-3

PINGENTE DECORATIVO 2CM - 100PCS

CÓD. DE BARRA: 7908221656538

NCM: 58089000 IPI: 0%



REF.: AR0993-4

PINGENTE DECORATIVO 2CM - 100PCS

CÓD. DE BARRA: 7908221656712

NCM: 58089000 IPI: 0%



REF.: AR0993-33

PINGENTE DECORATIVO 2CM - 100PCS

CÓD. DE BARRA: 7908221656699

NCM: 58089000 IPI: 0%



REF.: AR0993-2

PINGENTE DECORATIVO 2CM - 100PCS

CÓD. DE BARRA: 7908221656521

NCM: 58089000 IPI: 0%



REF.: AR0993-13

PINGENTE DECORATIVO 2CM - 100PCS

CÓD. DE BARRA: 7908221656613

NCM: 58089000 IPI: 0%



REF.: AR0993-10

PINGENTE DECORATIVO 2CM - 100PCS

CÓD. DE BARRA: 7908221656583

NCM: 58089000 IPI: 0%



REF.: AR0993-11

PINGENTE DECORATIVO 2CM - 100PCS

CÓD. DE BARRA: 7908221656590

NCM: 58089000 IPI: 0%



REF.: AR0993-12

PINGENTE DECORATIVO 2CM - 100PCS

CÓD. DE BARRA: 7908221656606

NCM: 58089000 IPI: 0%



REF.: AR0993-20

PINGENTE DECORATIVO 2CM - 100PCS

CÓD. DE BARRA: 7908221656651

NCM: 58089000 IPI: 0%



REF.: AR0993-9

PINGENTE DECORATIVO 2CM - 100PCS

CÓD. DE BARRA: 7908221656576

NCM: 58089000 IPI: 0%



REF.: AR0993-35

PINGENTE DECORATIVO 2CM - 100PCS

CÓD. DE BARRA: 7908221656712

NCM: 58089000 IPI: 0%



REF.: AR0993-17

PINGENTE DECORATIVO 2CM - 100PCS

CÓD. DE BARRA: 7908221656637

NCM: 58089000 IPI: 0%



REF.: AR0993-16

PINGENTE DECORATIVO 2CM - 100PCS

CÓD. DE BARRA: 7908221656620

NCM: 58089000 IPI: 0%



REF.: AR0993-34

PINGENTE DECORATIVO 2CM - 100PCS

CÓD. DE BARRA: 7908221656705

NCM: 58089000 IPI: 0%



REF.: AR0993-19

PINGENTE DECORATIVO 2CM - 100PCS

CÓD. DE BARRA: 7908221656644

NCM: 58089000 IPI: 0%



REF.: AR0993-22

PINGENTE DECORATIVO 2CM - 100PCS

CÓD. DE BARRA: 7908221656668

NCM: 58089000 IPI: 0%



REF.: AR0993-MIX

PINGENTE DECORATIVO 2CM - 100PCS

CÓDIGO DE BARRA: 7908221656736

NCM: 58089000 IPI: 0%

PINGENTES

PINGENTE DECORATIVO TIPO TASSEL

PACOTE COM 100 UNIDADES

NCM: 5809.00.00 IPI: 0%

R\$ 30,00

PREÇO PACOTE



3,5 cm



REF.: AR0992-01

CÓDIGO DE BARRA: 7908221686887



REF.: AR0992-09

CÓDIGO DE BARRA: 7908221686771



REF.: AR0992-28

CÓDIGO DE BARRA: 7908221686900



REF.: AR0992-35

CÓDIGO DE BARRA: 7908221686818



REF.: AR0992-42

CÓDIGO DE BARRA: 7908221686849



REF.: AR0992-54

CÓDIGO DE BARRA: 7908221686832



REF.: AR0992-55

CÓDIGO DE BARRA: 7908221686801



REF.: AR0992-56

CÓDIGO DE BARRA: 7908221686764



REF.: AR0992-62

CÓDIGO DE BARRA: 7908221686757



REF.: AR0992-67

CÓDIGO DE BARRA: 7908221686894



REF.: AR0992-69

CÓDIGO DE BARRA: 7908221686795



REF.: AR0992-70

CÓDIGO DE BARRA: 7908221686788

PINGENTES



REF.: AR0992-81

CÓDIGO DE BARRA: 7908221686948



REF.: AR0992-87

CÓDIGO DE BARRA: 7908221686825



REF.: AR0992-91

CÓDIGO DE BARRA: 7908221686863



REF.: AR0992-100

CÓDIGO DE BARRA: 7908221686924



REF.: AR0992-103

CÓDIGO DE BARRA: 7908221686856



REF.: AR0992-105

CÓDIGO DE BARRA: 7908221686917



REF.: AR0992-134

CÓDIGO DE BARRA: 7908221686870



REF.: AR0992-1143

CÓDIGO DE BARRA: 7908221686931

PINGENTES



PINGENTE CHEIO DECORATIVO PACOTE COM 12 UNID

CX MASTER 200 PACOTES

FRAÇÃO PACOTE C/ 12

R\$ 19,20

PREÇO PACOTE

NESTA CONDIÇÃO A UNIDADE FICA R\$ 1,60

R\$ 21,60

PREÇO UNITÁRIO

NESTA CONDIÇÃO A UNIDADE FICA R\$ 1,80



REF: AR9991-1

COR: BRANCO

CÓD. DE BARRA: 7908221605116

NCM: 5808.90.00 IPI: 0%

REF: AR9991-14

COR: OFF WITHE

CÓD. DE BARRA: 7908221605246

NCM: 5808.90.00 IPI: 0%

REF: AR9991-5

COR: BEGE CLARO

CÓD. DE BARRA: 7908221605154

NCM: 5808.90.00 IPI: 0%

REF: AR9991-13

COR: AMARELO

CÓD. DE BARRA: 7908221605239

NCM: 5808.90.00 IPI: 0%

REF: AR9991-12

COR: ÍRIS

CÓD. DE BARRA: 7908221605222

NCM: 5808.90.00 IPI: 0%



REF: AR9991-21

COR: ROSE BICOLOR

CÓD. DE BARRA: 7908221637414

NCM: 5808.90.00 IPI: 0%

REF: AR9991-6

COR: ROSÉ

CÓD. DE BARRA: 7908221605192

NCM: 5808.90.00 IPI: 0%

REF: AR9991-11

COR: VERMELHO

CÓD. DE BARRA: 7908221605215

NCM: 5808.90.00 IPI: 0%

REF: AR9991-16

COR: VINHO

CÓD. DE BARRA: 7908221605260

NCM: 5808.90.00 IPI: 0%

REF: AR9991-18

COR: MARRON

CÓD. DE BARRA: 7908221637384

NCM: 5808.90.00 IPI: 0%



REF: AR9991-7

COR: MARRON CAFÉ

CÓD. DE BARRA: 7908221605178

NCM: 5808.90.00 IPI: 0%

REF: AR9991-9

COR: PRETO

CÓD. DE BARRA: 7908221605192

NCM: 5808.90.00 IPI: 0%

REF: AR9991-2

COR: MUSGO

CÓD. DE BARRA: 7908221605123

NCM: 5808.90.00 IPI: 0%

REF: AR9991-4

COR: VERDE ESCURO

CÓD. DE BARRA: 7908221605147

NCM: 5808.90.00 IPI: 0%

REF: AR9991-15

COR: PETRÓLEO

CÓD. DE BARRA: 7908221605253

NCM: 5808.90.00 IPI: 0%



REF: AR9991-10

COR: AZUL MARINHO

CÓD. DE BARRA: 7908221605208

NCM: 5808.90.00 IPI: 0%

REF: AR9991-20

COR: LILÁS

CÓD. DE BARRA: 7908221637407

NCM: 5808.90.00 IPI: 0%

REF: AR9991-3

COR: CINZA

CÓD. DE BARRA: 7908221605130

NCM: 5808.90.00 IPI: 0%

REF: AR9991-8

COR: FENDI

CÓD. DE BARRA: 7908221605185

NCM: 5808.90.00 IPI: 0%

REF: AR9991-22

COR: BICOLOR

CÓD. DE BARRA: 7908221637421

NCM: 5808.90.00 IPI: 0%



REF: AR9991-23

COR: BICOLOR

CÓD. DE BARRA: 7908221637438

NCM: 5808.90.00 IPI: 0%

REF: AR9991-17

COR: BICOLOR

CÓD. DE BARRA: 7908221637377

NCM: 5808.90.00 IPI: 0%

REF: AR9991-19

COR: BICOLOR

CÓD. DE BARRA: 7908221637391

NCM: 5808.90.00 IPI: 0%

PINGENTES



9 cm

REF.: AR0998-1

PINGENTE 9CM - 50PCS

CÓDIGO DE BARRA: 7908221636660

NCM: 58089000 IPI: 0%

FRAÇÃO PACOTE

R\$ 21,90

PREÇO PACOTE



MODO DE EMBALAGEM



REF.: AR0998-1

PINGENTE 9CM - 50PCS

CÓDIGO DE BARRA: 7908221636660

NCM: 58089000 IPI: 0%



REF.: AR0998-2

PINGENTE 9CM - 50PCS

CÓDIGO DE BARRA: 7908221636677

NCM: 58089000 IPI: 0%



REF.: AR0998-4

PINGENTE 9CM - 50PCS

CÓDIGO DE BARRA: 7908221636691

NCM: 58089000 IPI: 0%



REF.: AR0998-5

PINGENTE 9CM - 50PCS

CÓDIGO DE BARRA: 7908221636707

NCM: 58089000 IPI: 0%



REF.: AR0998-27

PINGENTE 9CM - 50PCS

CÓDIGO DE BARRA: 7908221657009

NCM: 58089000 IPI: 0%



REF.: AR0998-29

PINGENTE 9CM - 50PCS

CÓDIGO DE BARRA: 7908221657023

NCM: 58089000 IPI: 0%



REF.: AR0998-22

PINGENTE 9CM - 50PCS

CÓDIGO DE BARRA: 7908221636875

NCM: 58089000 IPI: 0%



REF.: AR0998-17

PINGENTE 9CM - 50PCS

CÓDIGO DE BARRA: 7908221636820

NCM: 58089000 IPI: 0%



REF.: AR0998-9

PINGENTE 9CM - 50PCS

CÓDIGO DE BARRA: 7908221636745

NCM: 58089000 IPI: 0%



REF.: AR0998-10

PINGENTE 9CM - 50PCS

CÓDIGO DE BARRA: 7908221636752

NCM: 58089000 IPI: 0%



REF.: AR0998-31

PINGENTE 9CM - 50PCS

CÓDIGO DE BARRA: 7908221657023

NCM: 58089000 IPI: 0%

PINGENTES



REF.:AR0997-1

PINGENTE CHEIO BRILHANTE
APROX. 10 CM - 1X10 - COR: 1
CÓDIGO DE BARRA: 7908221636950
NCM: 5808.90.00 IPI: 0%

FRAÇÃO 12 PACOTES

R\$ 4,40

PREÇO PACOTE



REF.: AR0997-2

PINGENTE CHEIO BRILHANTE
APROX. 10 CM - 1X10 - COR: 2
CÓDIGO DE BARRA: 7908221636967
NCM: 5808.90.00 IPI: 0%

FRAÇÃO 12 PACOTES

R\$ 4,40

PREÇO PACOTE



REF.:AR0997-3

PINGENTE CHEIO BRILHANTE
APROX. 10 CM - 1X10 - COR: 3
CÓDIGO DE BARRA: 7908221636974
NCM: 5808.90.00 IPI: 0%

FRAÇÃO 12 PACOTES

R\$ 4,40

PREÇO PACOTE



REF.: AR0997-4

PINGENTE CHEIO BRILHANTE
APROX. 10 CM - 1X10 - COR: 4
CÓDIGO DE BARRA: 7908221636981
NCM: 5808.90.00 IPI: 0%

FRAÇÃO 12 PACOTES

R\$ 4,40

PREÇO PACOTE



REF.: AR0997-5

PINGENTE CHEIO BRILHANTE
APROX. 10 CM - 1X10 - COR: 5
CÓDIGO DE BARRA: 7908221636998
NCM: 5808.90.00 IPI: 0%

FRAÇÃO 12 PACOTES

R\$ 4,40

PREÇO PACOTE



REF.: AR0997-6

PINGENTE CHEIO BRILHANTE
APROX. 10 CM - 1X10 - COR: 6
CÓDIGO DE BARRA: 7908221637001
NCM: 5808.90.00 IPI: 0%

FRAÇÃO 12 PACOTES

R\$ 4,40

PREÇO PACOTE



REF.:AR0997-7

PINGENTE CHEIO BRILHANTE
APROX. 10 CM - 1X10 - COR: 7
CÓDIGO DE BARRA: 7908221637018
NCM: 5808.90.00 IPI: 0%

FRAÇÃO 12 PACOTES

R\$ 4,40

PREÇO PACOTE



REF.: AR0997-8

PINGENTE CHEIO BRILHANTE
APROX. 10 CM - 1X10 - COR: 8
CÓDIGO DE BARRA: 7908221637025
NCM: 5808.90.00 IPI: 0%

FRAÇÃO 12 PACOTES

R\$ 4,40

PREÇO PACOTE

PINGENTES



REF.: AR0999-3

PINGENTE DECORATIVO 8 cm - 100 PCS

CÓDIGO DE BARRA: 7908221657818

NCM: 58081000 IPI: 0%

FRAÇÃO 12 PACOTES

R\$ 14,50

PREÇO PACOTE



REF.: AR0999-5

PINGENTE DECORATIVO 8 cm - 100 PCS

CÓDIGO DE BARRA: 7908221657771

NCM: 58081000 IPI: 0%

FRAÇÃO 12 PACOTES

R\$ 14,50

PREÇO PACOTE



REF.: AR0999-24

PINGENTE DECORATIVO 8 cm - 100 PCS

CÓDIGO DE BARRA: 7908221657757

NCM: 58081000 IPI: 0%

FRAÇÃO 12 PACOTES

R\$ 14,50

PREÇO PACOTE



REF.: AR0999-34

PINGENTE DECORATIVO 8 cm - 100 PCS

CÓDIGO DE BARRA: 7908221657740

NCM: 58081000 IPI: 0%

FRAÇÃO 12 PACOTES

R\$ 14,50

PREÇO PACOTE



REF.: AR0999-39

PINGENTE DECORATIVO 8 cm - 100 PCS

CÓDIGO DE BARRA: 7908221657719

NCM: 58081000 IPI: 0%

FRAÇÃO 12 PACOTES

R\$ 14,50

PREÇO PACOTE

GLITTER COLORIDO



PACOTE DE GLITTER 500g PARA ARTESANATO

CX MASTER 50 PCT FRAÇÃO PACOTE

R\$ 18,50
PREÇO PACOTE

R\$ 20,35
PREÇO PACOTE



REF.: AR44-VERMELHO
GLITTER VERMELHO P/ ARTESANATO - 500g
CÓDIGO DE BARRA: 7898964642946
NCM: 3920.20.90 IPI: 9,75%



REF.: AR44-PINK
GLITTER PINK P/ ARTESANATO - 500g
CÓDIGO DE BARRA: 7898964642939
NCM: 3920.20.90 IPI: 9,75%



REF.: AR44-OURO
GLITTER DOURADO P/ ARTESANATO - 500g
CÓDIGO DE BARRA: 7898964642953
NCM: 3920.20.90 IPI: 9,75%



REF.: AR44-TURQUESA
GLITTER AZUL TURQUESA P/ ARTESANATO - 500g
CÓDIGO DE BARRA: 7898964642908
NCM: 3920.20.90 IPI: 9,75%



REF.: AR44-ROYAL
GLITTER ROYAL P/ ARTESANATO - 500g
CÓDIGO DE BARRA: 7898964642915
NCM: 3920.20.90 IPI: 9,75%



REF.: AR44-VERDE
GLITTER VERDE P/ ARTESANATO - 500g
CÓDIGO DE BARRA: 7898964642922
NCM: 3920.20.90 IPI: 9,75%



REF.: AR44-PRATA
GLITTER PRATEADO P/ ARTESANATO - 500g
CÓDIGO DE BARRA: 7898964642489
NCM: 3920.20.90 IPI: 9,75%

GLITTER IRISADO



**BRILHO ÍRISADO
(FURTA COR)**

PACOTE DE GLITTER ÍRIS 500g

CX MASTER 50 PCT FRAÇÃO PACOTE

R\$ 29,65

PREÇO PACOTE

R\$ 32,60

PREÇO PACOTE



REF.: AR44-IRIS

GLITTER IRISADO P/ ARTESANATO 500g

CÓDIGO DE BARRA: 7898964642892

NCM: 3920.20.90 IPI: 9,75%



REF.: AR44-AMARELO

GLITTER AMARELO ÍRIS P/ ARTESANATO 500g

CÓDIGO DE BARRA: 7908221635250

NCM: 3920.20.90 IPI: 9,75%



REF.: AR44-ROSA

GLITTER ROSA ÍRIS P/ ARTESANATO 500g

CÓDIGO DE BARRA: 7908221638657

NCM: 3920.20.90 IPI: 9,75%



REF.: AR44-LARANJA

GLITTER LARANJA ÍRIS P/ ARTESANATO 500g

CÓDIGO DE BARRA: 7908221635274

NCM: 3920.20.90 IPI: 9,75%

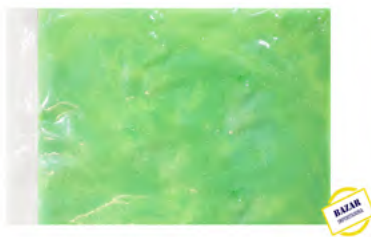

REF.: AR44-LIMAO

GLITTER VERDE ÍRIS P/ ARTESANATO 500g

CÓDIGO DE BARRA: 7908221638640

NCM: 3920.20.90 IPI: 9,75%



REF.: AR44-AZUL

GLITTER AZUL ÍRIS P/ARTESANATO 500g

CÓDIGO DE BARRA: 7908221635267

NCM: 3920.20.90 IPI: 9,75%

2 TONS NO ESTOQUE



REF.: AR44-ROXO

GLITTER ROXO ÍRIS P/ ARTESANATO 500g

CÓDIGO DE BARRA: 7898964642496

NCM: 3920.20.90 IPI: 9,75%

2 TONS NO ESTOQUE



GLITTER DIVERSOS



2 TONS NO ESTOQUE

REF.: AR44-BRANCO

GLITTER BRANCO P/ ARTESANATO - 500g

CÓDIGO DE BARRA: 7908221635243

NCM: 3920.20.90 IPI: 9,75%

CX MASTER 50 PCT

FRAÇÃO PACOTE

R\$ 22,50

PREÇO PACOTE

R\$ 24,75

PREÇO PACOTE

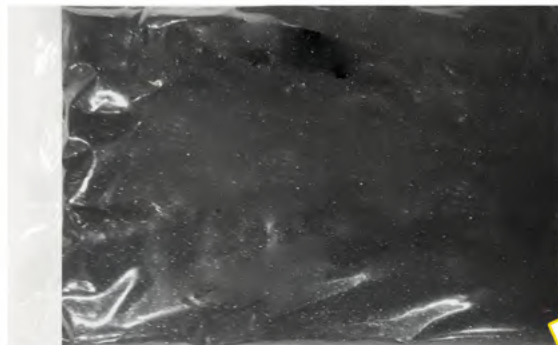

REF.: AR44-PRETO

GLITTER PRETO P/ ARTESANATO - 500g

CÓDIGO DE BARRA: 7908221635236

NCM: 3920.20.90 IPI: 9,75%

CX MASTER 50 PCT

FRAÇÃO PACOTE

R\$ 22,50

PREÇO PACOTE

R\$ 24,75

PREÇO PACOTE



REF.: AR2014-2

CARTELA DE GLITTER - 1,5 g cada

CÓDIGO DE BARRA: 7908221676352

NCM: 3920.20.90 IPI: 9,75%

CX MASTER 300 KITS

FRAÇÃO KIT C/ 24 UNID

R\$ 7,30

PREÇO KIT

R\$ 7,05

PREÇO KIT



REF.: AR2014-1

CARTELA DE GLITTER - 1,5 g cada

CÓDIGO DE BARRA: 7908221676369

NCM: 3920.20.90 IPI: 9,75%

CX MASTER 600 KITS

FRAÇÃO KIT C/ 12 UNID

R\$ 3,65

PREÇO KIT

R\$ 4,05

PREÇO KIT



REF.: AR2013

KIT GLITTER COM COLA - 10 g

CÓDIGO DE BARRA: 7908221676451

NCM: 3920.20.90 IPI: 9,75%

CX MASTER 240 KITS

FRAÇÃO KIT C/ 12 UNID

R\$ 4,65

PREÇO KIT

R\$ 5,15

PREÇO KIT



REF.: AR2013-C

KIT GLITTER COM COLA - 10 g

CÓDIGO DE BARRA: 7908221676468

NCM: 3920.20.90 IPI: 9,75%

CX MASTER 240 KITS

FRAÇÃO KIT C/ 12 UNID

R\$ 4,65

PREÇO KIT

R\$ 5,15

PREÇO KIT



GLITTER DIVERSOS



REF.: AR2011

KIT GLITTER COM COLA - 45 g

CÓDIGO DE BARRA: 7908221676437

NCM: 3920.20.90 IPI: 9,75%

CX MASTER 576 UNID **FRAÇÃO 12 UNID MIX**

R\$ 2,55

PREÇO UNITÁRIO

R\$ 2,85

PREÇO UNITÁRIO



REF.: AR2012

KIT GLITTER COM COLA - 100 g

CÓDIGO DE BARRA: 7908221676444

NCM: 3920.20.90 IPI: 9,75%

CX MASTER 144 UNID **FRAÇÃO 12 UNID MIX**

R\$ 3,30

PREÇO UNITÁRIO

R\$ 3,65

PREÇO UNITÁRIO



REF.: AR2010

KIT GLITTER COM COLA - 30 g

CÓDIGO DE BARRA: 7908221676420

NCM: 3920.20.90 IPI: 9,75%

CX MASTER 576 UNID **FRAÇÃO 12 UNID MIX**

R\$ 1,70

PREÇO UNITÁRIO

R\$ 1,90

PREÇO UNITÁRIO

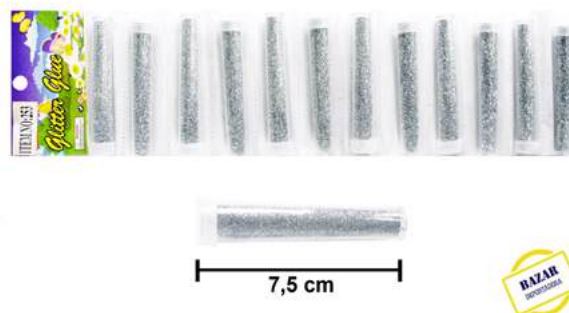

REF.: AR2021-S

GLITTER PRATA P/ ARTESANATO 1X12

CÓDIGO DE BARRA: 7908221641329

NCM: 3920.20.90 IPI: 9,75%

FRAÇÃO CARTELA COM 12 TUBOS

R\$ 7,30

PREÇO CARTELA

GLITTER DIVERSOS



REF.: AR2019-G

CÓDIGO DE BARRA: 7908221635311



GLITTER PARA ARTESANATO 100g

KIT COM 12 UNIDADES

NCM: 3920.20.90 IPI: 9,75%

CX MASTER 240 UNID FRAÇÃO CAIXA C/ 12 UNID

R\$ 4,90
PREÇO UNITÁRIO

R\$ 5,40
PREÇO UNITÁRIO



REF.: AR2019-GR

CÓDIGO DE BARRA: 7908221635373



REF.: AR2019-P

CÓDIGO DE BARRA: 7908221635328



REF.: AR2019-RB

CÓDIGO DE BARRA: 7908221635335



REF.: AR2019-B

CÓDIGO DE BARRA: 7908221635342



REF.: AR2019-PK

CÓDIGO DE BARRA: 7908221635359



REF.: AR2019-R

CÓDIGO DE BARRA: 7908221635366



REF.: AR2020-O

CÓDIGO DE BARRA: 7908221635441



GLITTER ÍRIS PARA ARTESANATO 100g

KIT COM 12 UNIDADES

NCM: 3920.20.90 IPI: 9,75%

CX MASTER 240 UNID FRAÇÃO CAIXA C/ 12 UNID

R\$ 4,90
PREÇO UNITÁRIO

R\$ 5,40
PREÇO UNITÁRIO



REF.: AR2020-W

CÓDIGO DE BARRA: 7908221635397



REF.: AR2020-P

CÓDIGO DE BARRA: 7908221635434



REF.: AR2020-SP

CÓDIGO DE BARRA: 7908221635458



REF.: AR2020-B

CÓDIGO DE BARRA: 7908221635427



REF.: AR2020-PK

CÓDIGO DE BARRA: 7908221635380



MINI ROSA EVA

MODO DE EMBALAGEM



REF.: AR0078-1

ENFEITE MINI ROSA 2.5 cm - BRANCO

CÓDIGO DE BARRA: 7908221618994

NCM: 39269090 IPI: 9,75

FRAÇÃO PACOTE C/ 144 UNID

R\$ 8,00 PROMOÇÃO!

PREÇO PACOTE



REF.: AR0078-2

ENFEITE MINI ROSA 2.5 cm - OFFWHITE

CÓDIGO DE BARRA: 7908221655852

NCM: 39269090 IPI: 9,75%

OUTRAS CORES:



ESGOTADO

REF.: AR0078-15

ENFEITE MINI ROSA 2.5 cm

CÓDIGO DE BARRA: 7908221667596

NCM: 39269090 IPI: 9,75



ESGOTADO

REF.: AR0078-21

ENFEITE MINI ROSA 2.5 cm - CREME

CÓDIGO DE BARRA: 7908221657641

NCM: 39269090 IPI: 9,75



REF.: AR0078-20

ENFEITE MINI ROSA 2.5 cm - BEGE

CÓDIGO DE BARRA: 7908221657634

NCM: 39269090 IPI: 9,75



REF.: AR0078-6

ENFEITE MINI ROSA 2.5 cm - SALMÃO

CÓDIGO DE BARRA: 7908221619045

NCM: 39269090 IPI: 9,75



REF.: AR0078-11

ENFEITE MINI ROSA 2.5 cm - AMARELO

CÓDIGO DE BARRA: 7908221619090

NCM: 39269090 IPI: 9,75



REF.: AR0078-4

ENFEITE MINI ROSA 2.5 cm VERMELHO

CÓDIGO DE BARRA: 7908221619021

NCM: 39269090 IPI: 9,75



ESGOTADO

REF.: AR0078-10

ENFEITE MINI ROSA 2.5 cm - PINK

CÓDIGO DE BARRA: 7908221619083

NCM: 39269090 IPI: 9,75



REF.: AR0078-3

ENFEITE MINI ROSA 2.5 cm - ROSA

CÓDIGO DE BARRA: 7908221619014

NCM: 39269090 IPI: 9,75



ESGOTADO

REF.: AR0078-14

ENFEITE MINI ROSA 2.5cm ROSA CLARO

CÓDIGO DE BARRA: 7908221619120

NCM: 39269090 IPI: 9,75



REF.: AR0078-5

ENFEITE MINI ROSA 2.5 cm LILÁS

CÓDIGO DE BARRA: 7908221619038

NCM: 39269090 IPI: 9,75



REF.: AR0078-19

ENFEITE MINI ROSA 2.5cm AZUL CLARO

CÓDIGO DE BARRA: 7908221657627

NCM: 39269090 IPI: 9,75



REF.: AR0078-8

ENFEITE MINI ROSA 2.5 cm AZUL

CÓDIGO DE BARRA: 7908221619069

NCM: 39269090 IPI: 9,75



REF.: AR0078-7

ENFEITE MINI ROSA 2.5 cm TURQUESA

CÓDIGO DE BARRA: 7908221619052

NCM: 39269090 IPI: 9,75



REF.: AR0078-12

ENFEITE MINI ROSA 2.5 cm VERDE

CÓDIGO DE BARRA: 7908221619106

NCM: 39269090 IPI: 9,75



REF.: AR0078-16

ENFEITE MINI ROSA 2.5 cm PRETO

CÓDIGO DE BARRA: 7908221619137

NCM: 39269090 IPI: 9,75



REF.: AR0078-17

ENFEITE MINI ROSA 2.5cm - ROYAL

CÓDIGO DE BARRA: 7908221619625

NCM: 39269090 IPI: 9,75%

MINI ROSA DE PAPEL



REF.: AR0088-1

ENFEITE MINI ROSA DE PAPEL - 1,5 cm X 1,8 cm

CÓDIGO DE BARRA: 7908221627545

NCM: 67029000 IPI: 9,75%

FRAÇÃO PACOTE 144 UND

R\$ 8,00

PREÇO PACOTE

PROMOÇÃO!



REF.: AR0088-3

MINI ROSA DE PAPEL 1,5 cm X 1,8 cm

CÓDIGO DE BARRA: 7908221627569

NCM: 67029000 IPI: 9,75%



REF.: AR0088-5

MINI ROSA DE PAPEL 1,5 cm X 1,8 cm

CÓDIGO DE BARRA: 7908221627583

NCM: 67029000 IPI: 9,75%



REF.: AR0088-16

MINI ROSA DE PAPEL - 1,5 cm X 1,8 cm

CÓDIGO DE BARRA: 7908221667589

NCM: 67029000 IPI: 9,75%



REF.: AR0088-9

MINI ROSA DE PAPEL 1,5 cm X 1,8 cm

CÓDIGO DE BARRA: 7908221627620

NCM: 67029000 IPI: 9,75%



REF.: AR0088-10

MINI ROSA DE PAPEL 1,5 cm X 1,8 cm

CÓDIGO DE BARRA: 7908221627637

NCM: 67029000 IPI: 9,75%



REF.: AR0088-11

MINI ROSA DE PAPEL 1,5 cm X 1,8 cm

CÓDIGO DE BARRA: 7908221627644

NCM: 67029000 IPI: 9,75%



REF.: AR0088-12

MINI ROSA DE PAPEL 1,5 cm X 1,8 cm

CÓDIGO DE BARRA: 7908221627651

NCM: 67029000 IPI: 9,75%



REF.: AR0088-13

MINI ROSA DE PAPEL 1,5 cm X 1,8 cm

CÓDIGO DE BARRA: 7908221627668

NCM: 67029000 IPI: 9,75%



REF.: AR0088-14

MINI ROSA DE PAPEL 1,5 cm X 1,8 cm

CÓDIGO DE BARRA: 7908221627675

NCM: 67029000 IPI: 9,75%



ESGOTADO

MINI ROSA DE PAPEL - 1,5 cm X 1,8 cm

CÓDIGO DE BARRA: 7908221627682

NCM: 67029000 IPI: 9,75%

ARTESANATO



REF.: LB0040

ADEREÇO DECORATIVO TIPO ENFEITE LÍRIO - 1X144

CÓDIGO DE BARRA: 7908221622786

NCM: 6702.90.00 IPI: 9,75%

CX MASTER 200 PCT **FRAÇÃO PCT C/ 144**

R\$ 26,40

PREÇO PACOTE

R\$ 29,65

PREÇO PACOTE

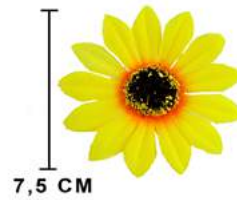

7,5 CM



REF.: LB0041-F1

ADEREÇO DECORATIVO FLOR MOD.1 - 1X100

CÓDIGO DE BARRA: 7908221634024

NCM: 9505.90.00 IPI: 13%

FRAÇÃO PCT C/ 100 UNID

R\$ 36,00

PREÇO PACOTE



10,5 CM



REF.: LB0041-F4

ADEREÇO DECORATIVO FLOR MOD.4 100 UND - 4 cm

CÓDIGO DE BARRA: 7908221666858

NCM: 95059000 IPI: 13%

FRAÇÃO 100 UND

R\$ 40,00

PREÇO PACOTE

REF.: LB0041-F2

ADEREÇO DECORATIVO FLOR MOD.2 - 1X100 PCS

CÓDIGO DE BARRA: 7908221634031

NCM: 9505.90.00 IPI: 13%

FRAÇÃO PACOTE C/ 100 UNID

R\$ 98,00

PREÇO PACOTE

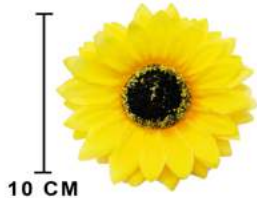

10 CM



REF.: : LB0041-F3

ADEREÇO DECORATIVO TIPO FLOR MOD.3 - 1X100

CÓDIGO DE BARRA: 7908221634048

NCM: 9505.90.00 IPI: 13%

FRAÇÃO PACOTE C/ 100 UNID

R\$ 98,00

PREÇO PACOTE



REF.: UT0023

AVENTAL IMPERMEÁVEL - 67 cm X 77 cm - 100 % POLIÉSTER

CÓDIGO DE BARRA: 7908221668111

NCM: 63029300 IPI: 0%

FRAÇÃO 10 UNID

R\$ 49,00

PREÇO UNIDADE

BAZAR
IMPORTADORA

ARTESANATO



REF.: AR0008-18

BOTÃO IMANTADO 18 MM - 1X100
CÓDIGO DE BARRA: 7908221603037
NCM: 96062900 IPI: 0%

CX MASTER 30 PACOTES FRAÇÃO PACOTE C/ 100 UNID

R\$ 30,00

PREÇO PACOTE

R\$ 33,50

PREÇO UNIDADE



REF.: AR0008-14

BOTÃO IMANTADO 14 MM - 1X200
CÓDIGO DE BARRA: 7908221603020
NCM: 96062900 IPI: 0%

CX MASTER 30 PACOTES FRAÇÃO PACOTE C/ 200 UNID

R\$ 51,00

PREÇO PACOTE

R\$ 56,00

PREÇO PACOTE



REF.: AR2024-187

FECHO PARA ETIQUETA 28CM - 100 PCS - BRANCO
CÓDIGO DE BARRA: 7908221655043
NCM: 39269090 IPI: 9,75%

CX MASTER 254 PACOTES FRAÇÃO 100 UNIDADES

R\$ 9,00

PREÇO PACOTE

R\$ 9,90

PREÇO PACOTE



REF.: AR2024-188

FECHO PARA ETIQUETA 28CM - 100 PCS - PRETO
CÓDIGO DE BARRA: 7908221655050
NCM: 39269090 IPI: 9,75%

CX MASTER 254 UND FRAÇÃO 100 UNIDADES

R\$ 9,00

PREÇO PACOTE

R\$ 9,90

PREÇO PACOTE

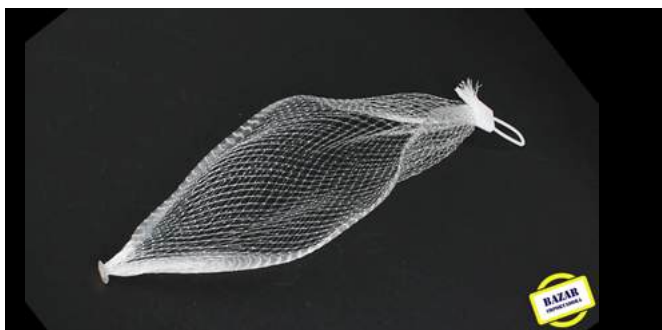

REF.: AR2024-BAG

EMBALAGEM COM FECHO APROX. 25 cm - 200 unidades
CÓDIGO DE BARRA: 7908221660313
NCM: 39232110 IPI:

FRAÇÃO PACOTE

R\$ 27,90

PREÇO PACOTE C/ 200 UND



ARTESANATO



REF.: AR5000-1

FITA COLANTE PARA ARTESANATO MOD. 1

CÓDIGO DE BARRA: 7908221625619

NCM: 4811.41.90 IPI: 3,25%

CX MASTER 48 KITS

FRAÇÃO KIT C/ 12 UNID

R\$ 24,45

PREÇO KIT

R\$ 26,90

PREÇO KIT



REF.: AR5000-2

FITA COLANTE PARA ARTESANATO MOD. 2

CÓDIGO DE BARRA: 7908221625626

NCM: 4811.41.90 IPI: 3,25%

CX MASTER 48 KITS

FRAÇÃO KIT C/ 12 UNID

R\$ 24,45

PREÇO KIT

R\$ 26,90

PREÇO KIT

ARTESANATO

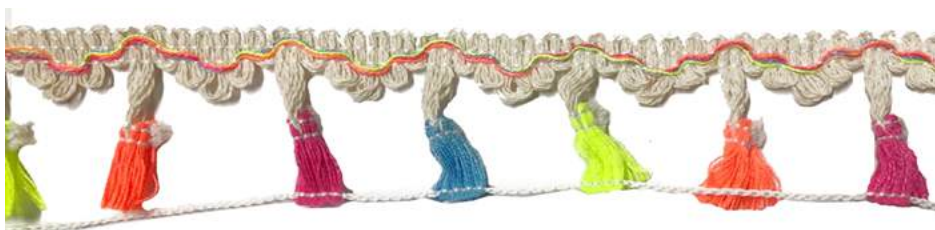

REF.AR0032-P1

CORDÃO PINGENTE PARA ARTESANATO

MOD. 1 - APROX. 4 CM X 10 JARDAS

CÓDIGO DE BARRA: 7908221636400

NCM: 5808.90.00 IPI: 0%

FRAÇÃO PEÇA

R\$ 15,90

PREÇO PEÇA



REF.: AR0032-P2

CORDÃO PINGENTE P/ ARTESANATO

MOD. 2 APROX. 4 CM X 10 JARDAS

CÓDIGO DE BARRA: 7908221636417

NCM: 5808.90.00 IPI: 0%

FRAÇÃO PEÇA

R\$ 14,90

PREÇO PEÇA

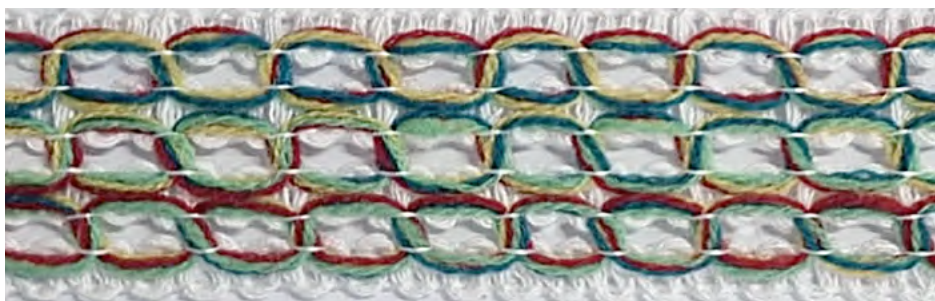

REF.: AR0048-5

PASSAMANARIA 4CM - 10 JARDAS

CÓDIGO DE BARRA: 7908221657368

NCM: 58089000 IPI: 0%

FRAÇÃO UNIDADE

R\$ 16,90

PREÇO UNIDADE



REF.: AR0028-1

GALÃO PLÁSTICO 0.8 MM

APROX. 30 M - COR: AZUL

CÓDIGO DE BARRA: 7908221634055

NCM: 3926.90.90 IPI: 9.75%

FRAÇÃO UNIDADE

R\$ 7,25

PREÇO POR UNIDADE

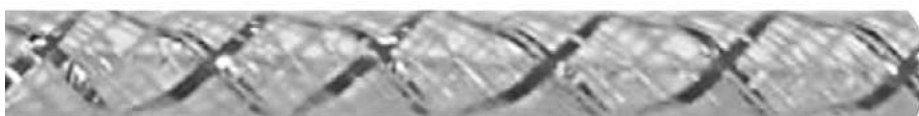

REF.: AR0030-S

GALÃO PLÁSTICO 0.4 MM

APROX. 50 M - COR: PRATA

CÓDIGO DE BARRA: 7908221634161

NCM: 3926.90.90 IPI: 9.75%

FRAÇÃO UNIDADE

R\$ 7,25

PREÇO POR UNIDADE

RENDAS

RENDA DE CETIM FRANZIDA

2,5 cm X 20 yd

100% POLIÉSTER

NCM: 5808.90.00 IPI: 0%

R\$ 31,75

PREÇO UNITÁRIO



2,5 cm

REF.: AR0131-01

CÓDIGO DE BARRA: 7908221682544



REF.: AR0131-02

CÓDIGO DE BARRA: 7908221682681



REF.: AR0131-04

CÓDIGO DE BARRA: 7908221682575



REF.: AR0131-05

CÓDIGO DE BARRA: 7908221682582



REF.: AR0131-17

CÓDIGO DE BARRA: 7908221682568



REF.: AR0131-19

CÓDIGO DE BARRA: 7908221682629



REF.: AR0131-20

CÓDIGO DE BARRA: 7908221682636



REF.: AR0131-21

CÓDIGO DE BARRA: 7908221682612



REF.: AR0131-23

CÓDIGO DE BARRA: 7908221682643

RENDAS



2,5 cm

REF.: AR0131-29

CÓDIGO DE BARRA: 7908221682650



REF.: AR0131-31

CÓDIGO DE BARRA: 7908221682605



REF.: AR0131-38

CÓDIGO DE BARRA: 7908221682674



REF.: AR0131-40

CÓDIGO DE BARRA: 7908221682667



REF.: AR0131-156

CÓDIGO DE BARRA: 7908221682698



REF.: AR0131-164

CÓDIGO DE BARRA: 7908221682551



REF.: AR0131-185

CÓDIGO DE BARRA: 7908221682537



REF.: AR0131-190

CÓDIGO DE BARRA: 7908221682599

RENDAS

RENDA DE ORGANZA FRANZIDA

2,5 cm X 20 m

100% POLIÉSTER

NCM: 5808.90.00 IPI: 0%

R\$ 32,90

PREÇO UNITÁRIO



2,5 cm

REF.: AR0132-BK10

CÓDIGO DE BARRA: 7908221682780



REF.: AR0132-BK15

CÓDIGO DE BARRA: 7908221682827



REF.: AR0132-BK19

CÓDIGO DE BARRA: 7908221682810



REF.: AR0132-BK24

CÓDIGO DE BARRA: 7908221682797



REF.: AR0132-BK30

CÓDIGO DE BARRA: 7908221682803



REF.: AR0132-1002

CÓDIGO DE BARRA: 7908221682773



REF.: AR0132-1005

CÓDIGO DE BARRA: 7908221682704

RENDAS



2,5 cm

REF.: AR0132-1015

CÓDIGO DE BARRA: 7908221682711



REF.: AR0132-1019

CÓDIGO DE BARRA: 7908221682728



REF.: AR0132-1023

CÓDIGO DE BARRA: 7908221682742



REF.: AR0132-1027

CÓDIGO DE BARRA: 7908221682759



REF.: AR0132-1040

CÓDIGO DE BARRA: 7908221682735



REF.: AR0132-1041

CÓDIGO DE BARRA: 7908221682766

FITA COM FLOR

FITA COM FLOR DE ORGANZA

10 jardas - Tamanho flor: 5 cm

100% Poliéster

NCM: 5808.90.00 IPI: 0%

R\$ 40,40

PREÇO UNITÁRIO



REF.: AR1014-80

CÓDIGO DE BARRA: 7908221681677



REF.: AR1014-72

CÓDIGO DE BARRA: 7908221681622



REF.: AR1014-104

CÓDIGO DE BARRA: 7908221681684



REF.: AR1014-01

CÓDIGO DE BARRA: 7908221681592



REF.: AR1014-11

CÓDIGO DE BARRA: 7908221681585



REF.: AR1014-15

CÓDIGO DE BARRA: 7908221681608



REF.: AR1014-16

CÓDIGO DE BARRA: 7908221681660



REF.: AR1014-23

CÓDIGO DE BARRA: 7908221681646



REF.: AR1014-29

CÓDIGO DE BARRA: 7908221681653



REF.: AR1014-31

CÓDIGO DE BARRA: 7908221681639



REF.: AR1014-35

CÓDIGO DE BARRA: 7908221681615

FITA FLORAL

FITA FLORAL COLORIDA

4 cm X 10 yd / Rolo
KIT COM 5 ROLOS
100% POLIÉSTER
NCM: 5806.32.00 IPI: 0%

FRAÇÃO 5 ROLOS

R\$ 16,75
PREÇO ROLO



4 cm

REF.: AR0121-1

CÓDIGO DE BARRA: 7908221678165



REF.: AR0121-2

CÓDIGO DE BARRA: 7908221678172



REF.: AR0121-3

CÓDIGO DE BARRA: 7908221678189



REF.: AR0121-4

CÓDIGO DE BARRA: 7908221678196



REF.: AR0121-5

CÓDIGO DE BARRA: 7908221678202



REF.: AR0121-6

CÓDIGO DE BARRA: 7908221678219



REF.: AR0121-7

CÓDIGO DE BARRA: 7908221678226

FITA FLORAL

FITA FLORAL COLORIDA

4 cm X 10 yd / Rolo
KIT COM 5 ROLOS
100% POLIÉSTER
NCM: 5806.32.00 IPI: 0%

FRAÇÃO 5 ROLOS

R\$ 16,75
PREÇO ROLO



4 cm

REF.: AR0121-8

CÓDIGO DE BARRA: 7908221678233



REF.: AR0121-9

CÓDIGO DE BARRA: 7908221678240

FITA DE VOAL

FITA DE VOAL

2,5 cm X 20 yd / Rolo

KIT COM 5 ROLOS

100% POLIÉSTER

NCM: 5806.32.00 IPI: 0%

FRAÇÃO 5 ROLOS

R\$ 10,50

PREÇO ROLO



2,5 cm

REF.: AR0126-1

CÓDIGO DE BARRA: 7908221678493



REF.: AR0126-2

CÓDIGO DE BARRA: 7908221678509



REF.: AR0126-3

CÓDIGO DE BARRA: 7908221678516



REF.: AR0126-4

CÓDIGO DE BARRA: 7908221678523



REF.: AR0126-5

CÓDIGO DE BARRA: 7908221678530



REF.: AR0126-6

CÓDIGO DE BARRA: 7908221678547



REF.: AR0126-7

CÓDIGO DE BARRA: 7908221678554

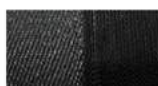

FITA DE VOAL

FITA FRANZIDA COM ELÁSTICO

3 cm X 10 m

100% POLIÉSTER

NCM: 5806.32.00 IPI: 0%



R\$ 9,95
PREÇO UNITÁRIO

TECIDO COM TRANSPARÊNCIA



REF: AR0120-0

CÓDIGO DE BARRA: 7908221678042



REF: AR0120-06

CÓDIGO DE BARRA: 7908221678103



REF: AR0120-14

CÓDIGO DE BARRA: 7908221678097



REF: AR0120-40

CÓDIGO DE BARRA: 7908221678059



REF: AR0120-49

CÓDIGO DE BARRA: 7908221678080



REF: AR0120-64

CÓDIGO DE BARRA: 7908221678073



REF: AR0120-66

CÓDIGO DE BARRA: 7908221678110



REF: AR0120-87

CÓDIGO DE BARRA: 7908221678066

FITA DE VOAL



3 cm

REF.: AR0120-93

CÓDIGO DE BARRA: 7908221678141



REF.: AR0120-96

CÓDIGO DE BARRA: 7908221678127



REF.: AR0120-116

CÓDIGO DE BARRA: 7908221678158



REF.: AR0120-144

CÓDIGO DE BARRA: 7908221678134

FITA DE VOAL

FITA DE VOAL 2 cm X 50 yd / Rolo (45 metros)

- KIT COM 5 ROLOS - 100% POLIÉSTER

NCM: 5806.32.00 IPI: 0%

FRAÇÃO KIT COM 5 ROLOS

R\$ 31,75

PREÇO KIT

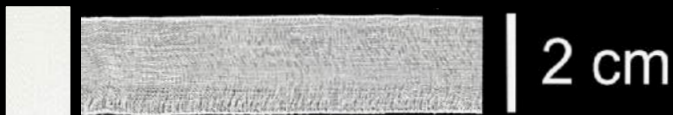

REF.: AR0127-1001

CÓDIGO DE BARRA: 7908221678561



REF.: AR0127-1002

CÓDIGO DE BARRA: 7908221678578



REF.: AR0127-1016

CÓDIGO DE BARRA: 7908221678592



REF.: AR0127-BK10

CÓDIGO DE BARRA: 7908221678684



REF.: AR0127-BK30

CÓDIGO DE BARRA: 7908221678721



REF.: AR0127-1026

CÓDIGO DE BARRA: 7908221678615



REF.: AR0127-1004

CÓDIGO DE BARRA: 7908221678585



REF.: AR0127-1041

CÓDIGO DE BARRA: 7908221678646



REF.: AR0127-1059

CÓDIGO DE BARRA: 7908221678653



REF.: AR0127-1040

CÓDIGO DE BARRA: 7908221678639

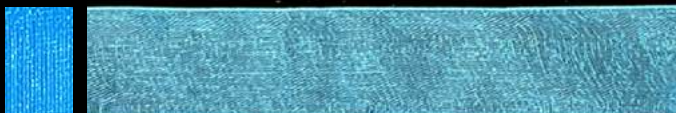

REF.: AR0127-BK15

CÓDIGO DE BARRA: 7908221678691



REF.: AR0127-1093

CÓDIGO DE BARRA: 7908221678660



REF.: AR0127-BK19

CÓDIGO DE BARRA: 7908221678707



REF.: AR0127-1039

CÓDIGO DE BARRA: 7908221678622



REF.: AR0127-BK20

CÓDIGO DE BARRA: 7908221678714



REF.: AR0127-BK09

CÓDIGO DE BARRA: 7908221678677



REF.: AR0127-1019

CÓDIGO DE BARRA: 7908221678608

FITA DE VOAL

FITA DE VOAL 2,5 cm X 50 yd / Rolo (45 metros)

FRAÇÃO KIT COM 5 ROLOS

- KIT COM 5 ROLOS - 100% POLIÉSTER

NCM: 5806.32.00 IPI: 0%

R\$ 37,55

PREÇO KIT

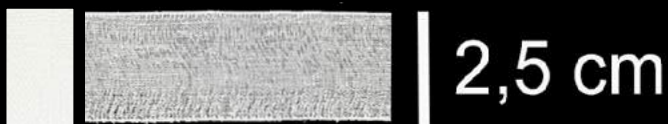

REF.: AR0128-1001

CÓDIGO DE BARRA: 7908221678738

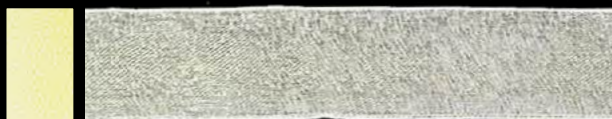

REF.: AR0128-1002

CÓDIGO DE BARRA: 7908221678745

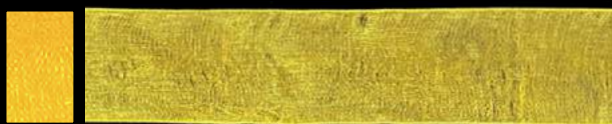

REF.: AR0128-1016

CÓDIGO DE BARRA: 7908221678769

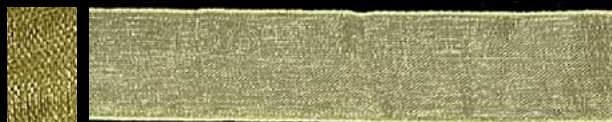

REF.: AR0128-BK10

CÓDIGO DE BARRA: 7908221678851



REF.: AR0128-BK30

CÓDIGO DE BARRA: 7908221678899



REF.: AR0128-1026

CÓDIGO DE BARRA: 7908221678783

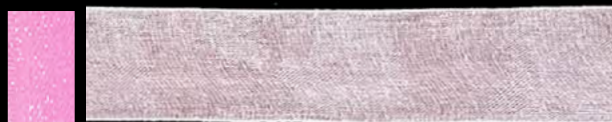

REF.: AR0128-1004

CÓDIGO DE BARRA: 7908221678752

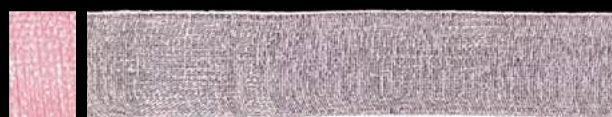

REF.: AR0128-1041

CÓDIGO DE BARRA: 7908221678813



REF.: AR0128-1059

CÓDIGO DE BARRA: 7908221678820



REF.: AR0128-1040

CÓDIGO DE BARRA: 7908221678806



REF.: AR0128-BK15

CÓDIGO DE BARRA: 7908221678868



REF.: AR0128-1093

CÓDIGO DE BARRA: 7908221678837



REF.: AR0128-BK19

CÓDIGO DE BARRA: 7908221678875



REF.: AR0128-1039

CÓDIGO DE BARRA: 7908221678790



REF.: AR0128-BK20

CÓDIGO DE BARRA: 7908221678882



REF.: AR0128-BK09

CÓDIGO DE BARRA: 7908221678844

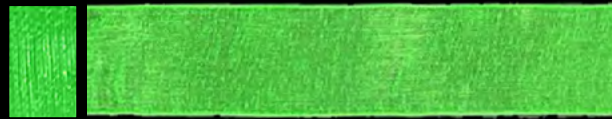

REF.: AR0128-1019

CÓDIGO DE BARRA: 7908221678776

FITA DE VOAL

FITA DE VOAL 4 cm X 50 yd / Rolo (45 metros)

- KIT COM 4 ROLOS - 100% POLIÉSTER

NCM: 5806.32.00 IPI: 0%

FRAÇÃO KIT COM 4 ROLOS

R\$ 46,20

PREÇO KIT



REF.: AR0129-1001

CÓDIGO DE BARRA: 7908221678905

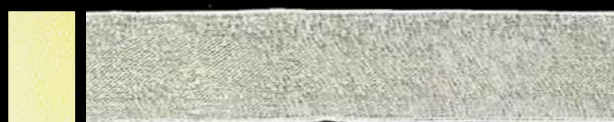

REF.: AR0129-1002

CÓDIGO DE BARRA: 7908221678912

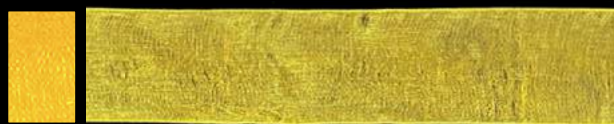

REF.: AR0129-1016

CÓDIGO DE BARRA: 7908221678936



REF.: AR0129-BK10

CÓDIGO DE BARRA: 7908221679025



REF.: AR0129-BK30

CÓDIGO DE BARRA: 7908221679063



REF.: AR0129-1026

CÓDIGO DE BARRA: 7908221678950



REF.: AR0129-1004

CÓDIGO DE BARRA: 7908221678929

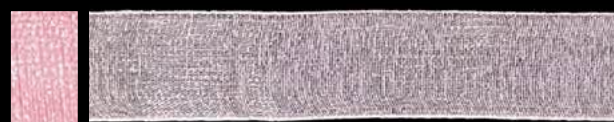

REF.: AR0129-1041

CÓDIGO DE BARRA: 7908221678981



REF.: AR0129-1059

CÓDIGO DE BARRA: 7908221678998



REF.: AR0129-1040

CÓDIGO DE BARRA: 7908221678974



REF.: AR0129-BK15

CÓDIGO DE BARRA: 7908221679032

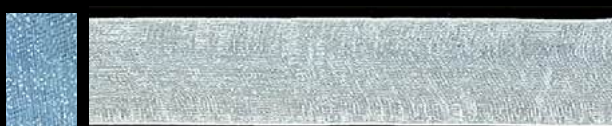

REF.: AR0129-1093

CÓDIGO DE BARRA: 7908221679001



REF.: AR0129-BK19

CÓDIGO DE BARRA: 7908221679049



REF.: AR0129-1039

CÓDIGO DE BARRA: 7908221678967



REF.: AR0129-BK20

CÓDIGO DE BARRA: 7908221679056



REF.: AR0129-BK09

CÓDIGO DE BARRA: 7908221679018

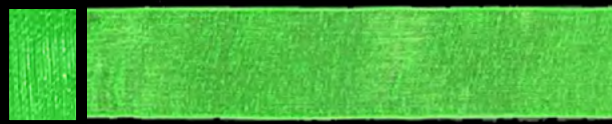

REF.: AR0129-1019

CÓDIGO DE BARRA: 7908221678943

FITA DE VOAL

FITA DE VOAL ESTAMPADA

4 cm X 10 yd / Rolo
KIT COM 5 ROLOS
100% POLIÉSTER
NCM: 5806.32.00 IPI: 0%

FRAÇÃO 5 ROLOS

R\$ 17,35

PREÇO ROLO



4 cm

REF.: AR0122-1

CÓDIGO DE BARRA: 7908221678257



REF.: AR0122-2

CÓDIGO DE BARRA: 7908221678264



REF.: AR0122-3

CÓDIGO DE BARRA: 7908221678271



REF.: AR0122-4

CÓDIGO DE BARRA: 7908221678288



REF.: AR0122-5

CÓDIGO DE BARRA: 7908221678295

FITA COM REMENDO DE 3 METROS EM 3 METROS

FITA DE VOAL

FITA DE VOAL- COM REMENDO

4 cm X 10 yd / Rolo
KIT COM 5 ROLOS
100% POLIÉSTER
NCM: 5806.32.00 IPI: 0%

FRAÇÃO 5 ROLOS

R\$ 8,70
PREÇO ROLO

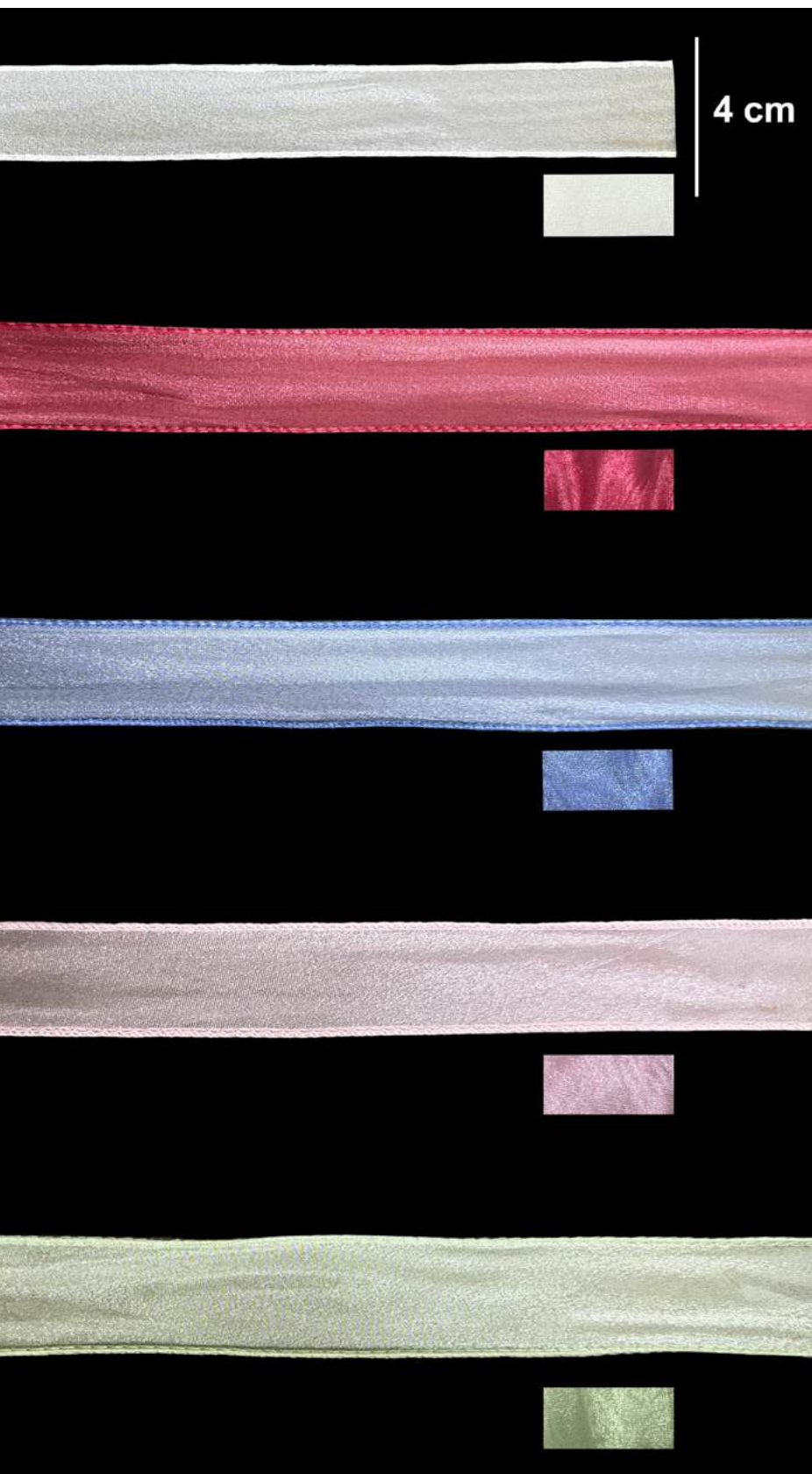

REF.: AR0123-1

CÓDIGO DE BARRA: 7908221678301

REF.: AR0123-2

CÓDIGO DE BARRA: 7908221678318

REF.: AR0123-3

CÓDIGO DE BARRA: 7908221678325

REF.: AR0123-4

CÓDIGO DE BARRA: 7908221678332

REF.: AR0123-5

CÓDIGO DE BARRA: 7908221678349

FITA COM REMENDO DE 3 METROS EM 3 METROS

FITA DE VOAL

FITA DE VOAL- COM REMENDO

4 cm X 10 yd / Rolo
KIT COM 5 ROLOS
100% POLIÉSTER
NCM: 5806.32.00 IPI: 0%

FRAÇÃO 5 ROLOS

R\$ 8,70
PREÇO ROLO

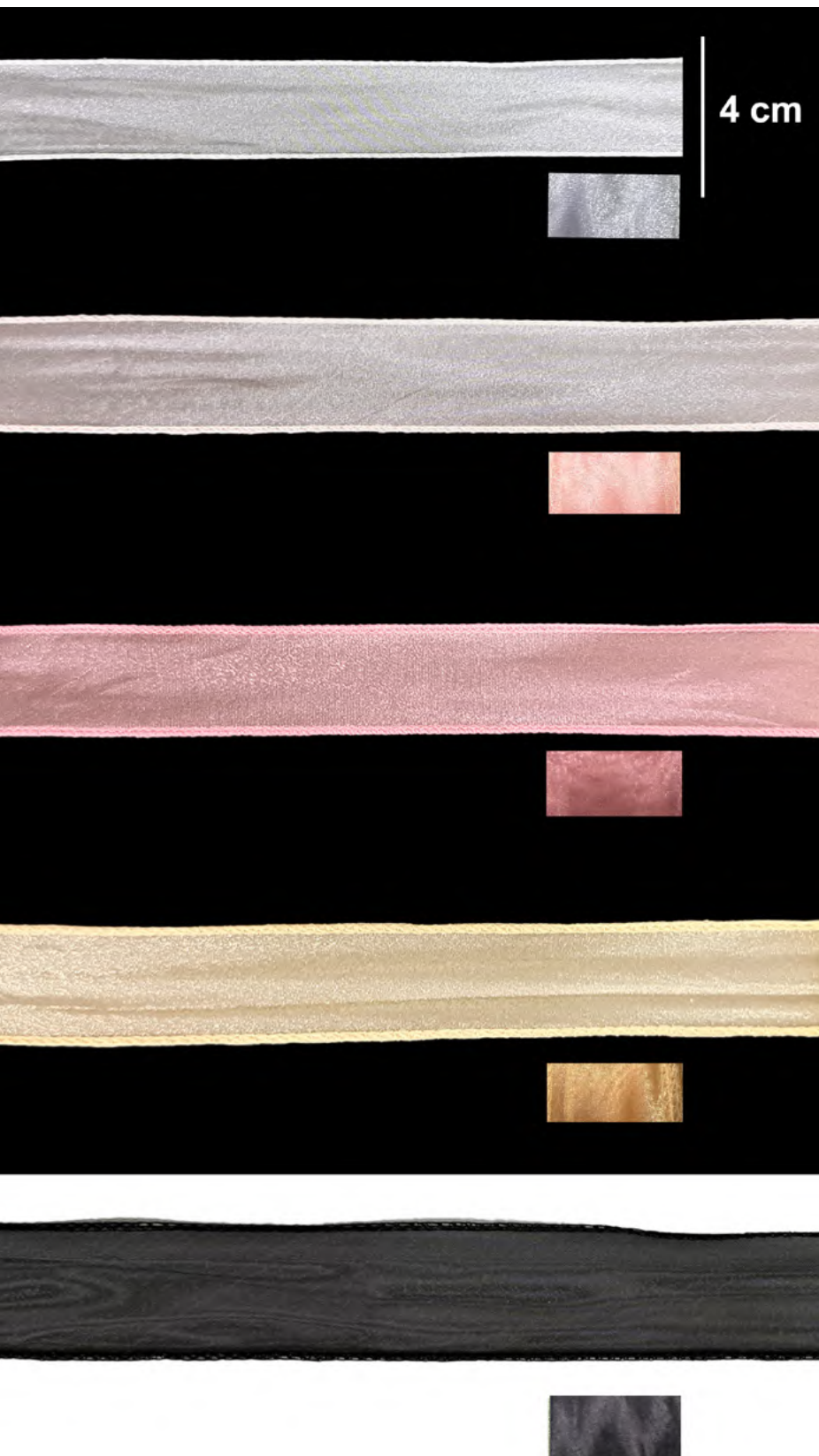

REF.: AR0123-6

CÓDIGO DE BARRA: 7908221678356

REF.: AR0123-7

CÓDIGO DE BARRA: 7908221678363

REF.: AR0123-8

CÓDIGO DE BARRA: 7908221678370

REF.: AR0123-9

CÓDIGO DE BARRA: 7908221678387

REF.: AR0123-10

CÓDIGO DE BARRA: 7908221678394

FITA COM REMENDO DE 3 METROS EM 3 METROS

FITA DE VOAL

FITA DE VOAL IRISADA - COM REMENDO

4 cm X 10 yd / Rolo
KIT COM 5 ROLOS
100% POLIÉSTER
NCM: 5806.32.00 IPI: 0%

FRAÇÃO 5 ROLOS

R\$ 14,50
PREÇO ROLO

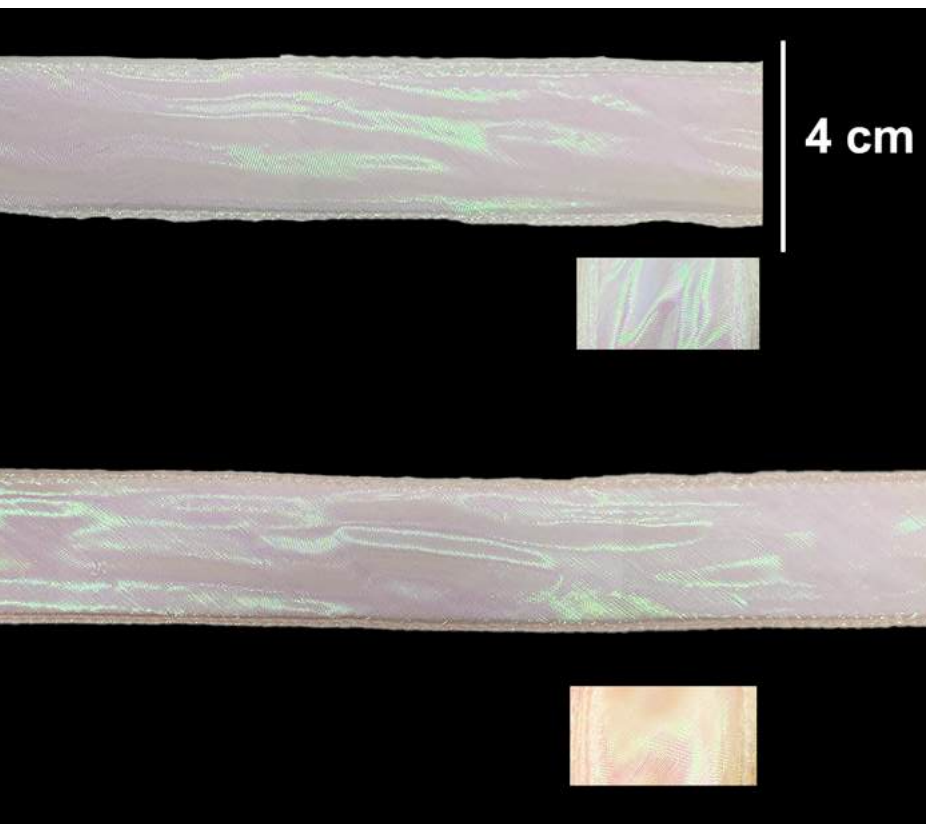

REF.: AR0124-1

CÓDIGO DE BARRA:

REF.: AR0124-2

CÓDIGO DE BARRA:

FITA COM REMENDO DE 3 METROS EM 3 METROS

FITA DE VOAL

FITA DE VOAL COM PÉROLA - COM REMENDO

4 cm X 10 yd / Rolo
KIT COM 5 ROLOS
100% POLIÉSTER
NCM: 5806.32.00 IPI: 0%

FRAÇÃO 5 ROLOS

R\$ 15,90
PREÇO ROLO

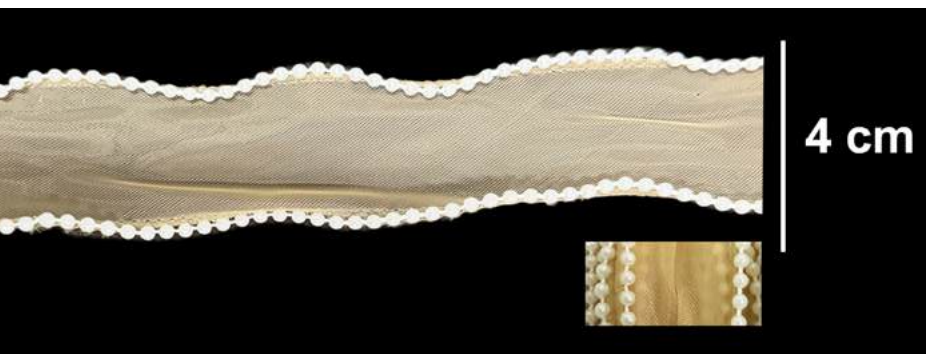

REF.: AR0125-1

CÓDIGO DE BARRA: 7908221678424



REF.: AR0125-2

CÓDIGO DE BARRA: 7908221678431



REF.: AR0125-3

CÓDIGO DE BARRA: 7908221678448



REF.: AR0125-4

CÓDIGO DE BARRA: 7908221678455

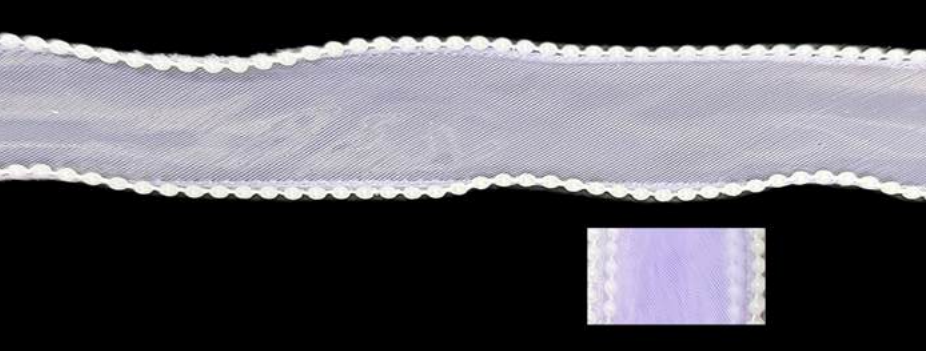

REF.: AR0125-5

CÓDIGO DE BARRA: 7908221678462

FITA COM REMENDO DE 3 METROS EM 3 METROS

FITA DE VOAL

FITA DE VOAL COM PÉROLA - COM REMENDO

4 cm X 10 yd / Rolo
KIT COM 5 ROLOS
100% POLIÉSTER
NCM: 5806.32.00 IPI: 0%

FRAÇÃO 5 ROLOS

R\$ 15,90
PREÇO ROLO

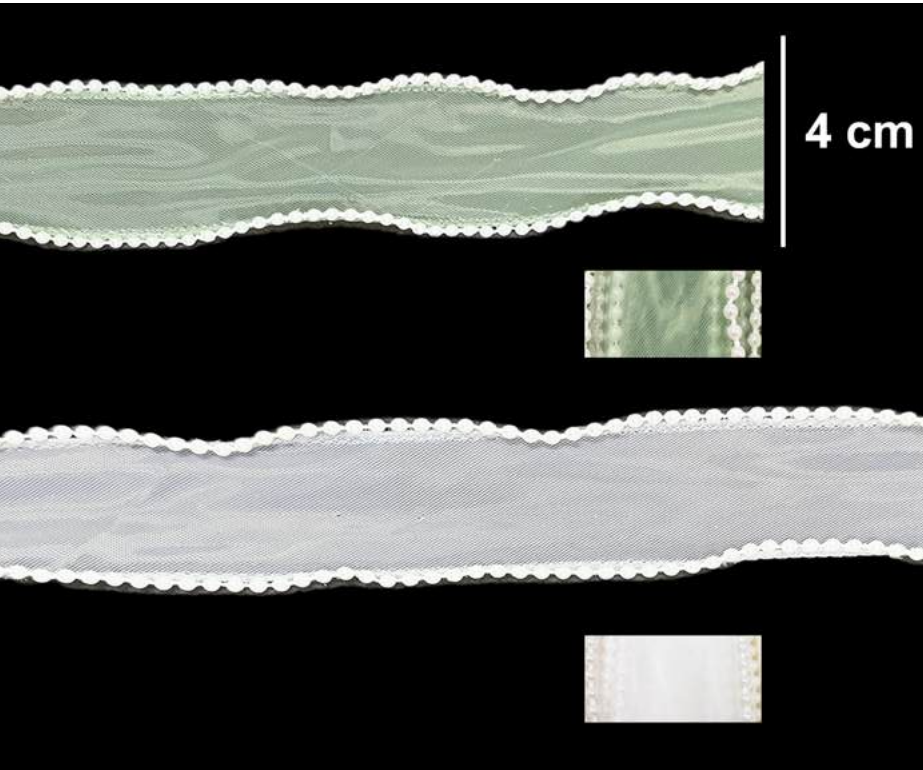

REF.: AR0125-6

CÓDIGO DE BARRA: 7908221678479

REF.: AR0125-7

CÓDIGO DE BARRA: 7908221678486

FITAS DOURADAS

AR0040-07G

FITA OURO - 0,7 cm X 25 yd

KIT COM 10 ROLOS - 25 yd o Rolo (22,80 metros)

100% POLIÉSTER

CÓDIGO DE BARRA: 7908221680847

NCM: 5808.89.00 IPI: 0%

FRAÇÃO KIT COM 10 ROLOS

R\$ 18,75

PREÇO KIT

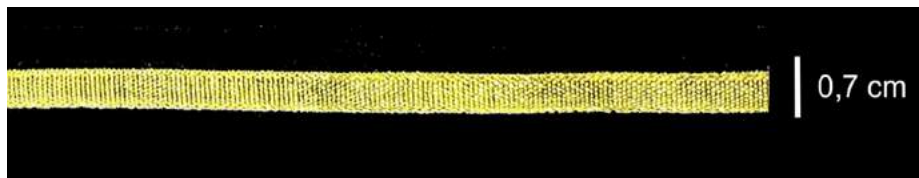

AR0040-1G

FITA OURO - 1 cm X 25 yd

KIT COM 10 ROLOS - 25 yd o Rolo (22,80 metros)

100% POLIÉSTER

CÓDIGO DE BARRA: 7908221680854

NCM: 5808.89.00 IPI: 0%

FRAÇÃO KIT COM 10 ROLOS

R\$ 23,10

PREÇO KIT

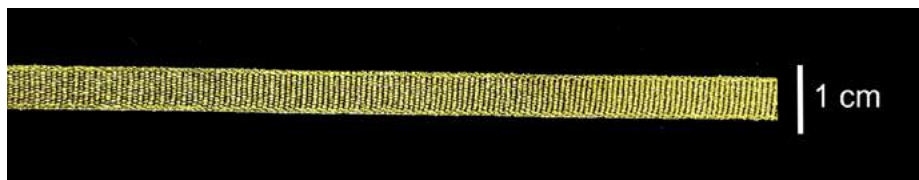

AR0040-1.2G

FITA OURO - 1,2 cm X 25 yd

KIT COM 10 ROLOS - 25 yd o Rolo (22,80 metros)

100% POLIÉSTER

CÓDIGO DE BARRA: 7908221680861

NCM: 5808.89.00 IPI: 0%

FRAÇÃO KIT COM 10 ROLOS

R\$ 26,00

PREÇO KIT



AR0040-1.5G

FITA OURO - 1,5 cm X 25 yd

KIT COM 10 ROLOS - 25 yd o Rolo (22,80 metros)

100% POLIÉSTER

CÓDIGO DE BARRA: 7908221680878

NCM: 5808.89.00 IPI: 0%

FRAÇÃO KIT COM 10 ROLOS

R\$ 28,15

PREÇO KIT

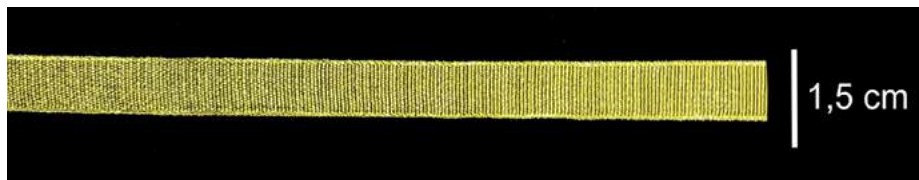

FITAS DOURADAS

AR0040-2G

FITA OURO - 2 cm X 25 yd

KIT COM 10 ROLOS - 25 yd o Rolo (22,80 metros)

100% POLIÉSTER

CÓDIGO DE BARRA: 7908221680885

NCM: 5808.89.00 IPI: 0%

FRAÇÃO KIT COM 10 ROLOS

R\$ 37,55

PREÇO KIT



AR0040-3G

FITA OURO - 3 cm X 25 yd

KIT COM 5 ROLOS - 25 yd o Rolo (22,80 metros)

100% POLIÉSTER

CÓDIGO DE BARRA: 7908221680892

NCM: 5808.89.00 IPI: 0%

FRAÇÃO KIT COM 5 ROLOS

R\$ 33,25

PREÇO KIT



AR0040-4G

FITA OURO - 4 cm X 25 yd

KIT COM 5 ROLOS - 25 yd o Rolo (22,80 metros)

100% POLIÉSTER

CÓDIGO DE BARRA: 7908221680908

NCM: 5808.89.00 IPI: 0%

FRAÇÃO KIT COM 5 ROLOS

R\$ 37,55

PREÇO KIT

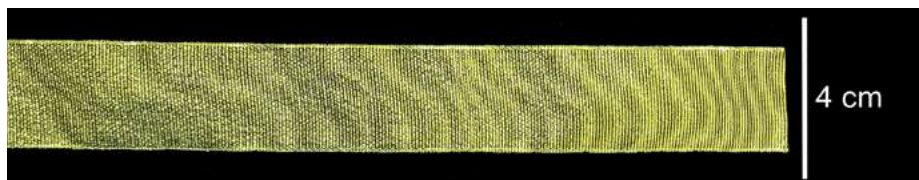

FITA METÁLICA



FITA MÉTALICA COM BRILHO

2 cm X 50 yd (rolo)

NCM: 5808.90.00 IPI: 0%

R\$ 30,20
PREÇO ROLO



REF.: AR0134-2-1

CÓDIGO DE BARRA: 7908221687754



REF.: AR0134-2-15

CÓDIGO DE BARRA: 7908221687853



REF.: AR0134-2-2

CÓDIGO DE BARRA: 7908221687761



ESGOTADO

CÓDIGO DE BARRA: 7908221687860



REF.: AR0134-2-3

CÓDIGO DE BARRA: 7908221687778



REF.: AR0134-2-17

CÓDIGO DE BARRA: 7908221687884



REF.: AR0134-2-5

CÓDIGO DE BARRA: 7908221687785



REF.: AR0134-2-18

CÓDIGO DE BARRA: 7908221687877



REF.: AR0134-2-6

CÓDIGO DE BARRA: 7908221687792



REF.: AR0134-2-26

CÓDIGO DE BARRA: 7908221687921



REF.: AR0134-2-8

CÓDIGO DE BARRA: 7908221687815



REF.: AR0134-2-11

CÓDIGO DE BARRA: 7908221687839



REF.: AR0134-2-9

CÓDIGO DE BARRA: 7908221687822

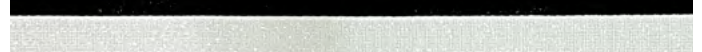

REF.: AR0134-2-7

CÓDIGO DE BARRA: 7908221687808



REF.: AR0134-2-13

CÓDIGO DE BARRA: 7908221687846



REF.: AR0134-2-28

CÓDIGO DE BARRA: 7908221687907

FITA METÁLICA



FITA MÉTALICA COM BRILHO

3,8 cm X 25 yd (rolo)

NCM: 5808.90.00 IPI: 0%

R\$ 36,75
PREÇO ROLO



REF.: AR0134-3-1

CÓDIGO DE BARRA: 7908221687938



REF.: AR0134-3-15

CÓDIGO DE BARRA: 7908221688034



REF.: AR0134-3-2

CÓDIGO DE BARRA: 7908221687945



REF.: AR0134-3-16

CÓDIGO DE BARRA: 7908221688041



REF.: AR0134-3-3

CÓDIGO DE BARRA: 7908221687952



REF.: AR0134-3-17

CÓDIGO DE BARRA: 7908221688065



REF.: AR0134-3-5

CÓDIGO DE BARRA: 7908221687969



REF.: AR0134-3-18

CÓDIGO DE BARRA: 7908221688058



REF.: AR0134-3-6

CÓDIGO DE BARRA: 7908221687976



REF.: AR0134-3-26

CÓDIGO DE BARRA: 7908221688102



REF.: AR0134-3-8

CÓDIGO DE BARRA: 7908221687990



REF.: AR0134-3-11

CÓDIGO DE BARRA: 7908221688010



REF.: AR0134-3-9

CÓDIGO DE BARRA: 7908221688003



REF.: AR0134-3-7

CÓDIGO DE BARRA: 7908221687983



REF.: AR0134-3-13

CÓDIGO DE BARRA: 7908221688027



REF.: AR0134-3-28

CÓDIGO DE BARRA: 7908221688089

FITA METÁLICA



FITA METÁLICA COM BRILHO

1 cm X 50 yd (rolo)

NCM: 5808.90.00 IPI: 0%

R\$ 15,75
PREÇO ROLO



REF: **ESGOTADO**

CÓD.BARRA: 7908221687570



REF: **AR0134-1-15**

CÓD.BARRA: 7908221687679



REF: **AR0134-1-2**

CÓD.BARRA: 7908221687587



REF: **ESGOTADO**

CÓD.BARRA: 7908221687636



REF: **AR0134-1-3**

CÓD.BARRA: 7908221687594



REF: **AR0134-1-17**

CÓD.BARRA: 7908221687709



REF: **AR0134-1-5**

CÓD. BARRA: 7908221687600



REF: **AR0134-1-18**

CÓD.BARRA: 7908221687693



REF: **ESGOTADO**

CÓD.BARRA: 7908221687617



REF: **AR0134-1-26**

CÓDIGO DE BARRA: 7908221687747



REF: **AR0134-1-8**

CÓD.BARRA: 7908221687631



REF: **AR0134-1-11**

CÓDIGO DE BARRA: 7908221687655



REF: **ESGOTADO**

CÓD.BARRA: 7908221687648



REF: **AR0134-1-7**

CÓDIGO DE BARRA: 7908221687624



REF: **AR0134-1-13**

CÓD.BARRA: 7908221687662



REF: **AR0134-1-28**

CÓDIGO DE BARRA: 7908221687723

FITA DE RENDA

FITA DE RENDA

3 cm X 25 yd

PACOTE COM 5 ROLOS

NCM: 5808.90.00 IPI: 0%

R\$ 14,05

PREÇO ROLO



3 cm

REF.: AR0133-R

CÓDIGO DE BARRA: 7908221682889



REF.: AR0133-RB

CÓDIGO DE BARRA: 7908221682926



REF.: AR0133-RX

CÓDIGO DE BARRA: 7908221682858



REF.: AR0133-LJ

CÓDIGO DE BARRA: 7908221682865

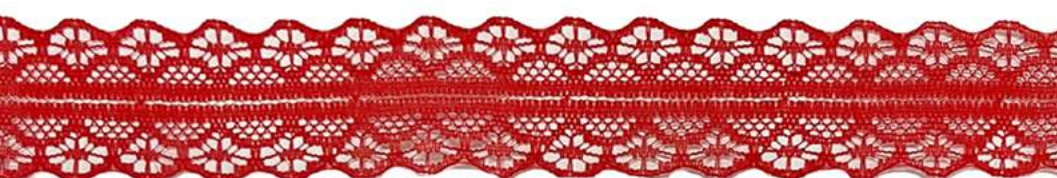

REF.: AR0133-VM

CÓDIGO DE BARRA: 7908221682902

FITA DE RENDA

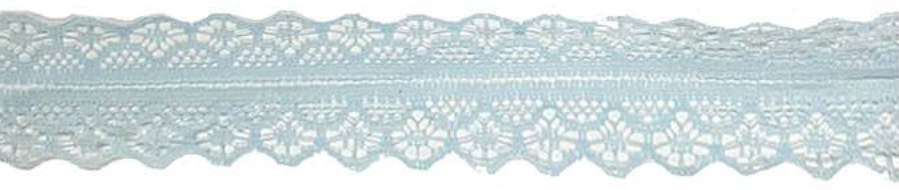

3 cm

REF.: AR0133-AB

CÓDIGO DE BARRA: 7908221682933



REF.: AR0133-AT

CÓDIGO DE BARRA: 7908221682872



REF.: AR0133-M

CÓDIGO DE BARRA: 7908221682896



REF.: AR0133-ME

CÓDIGO DE BARRA: 7908221682919

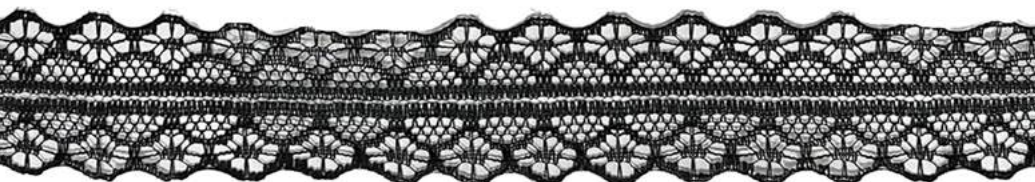

REF.: AR0133-B

CÓDIGO DE BARRA: 7908221682841

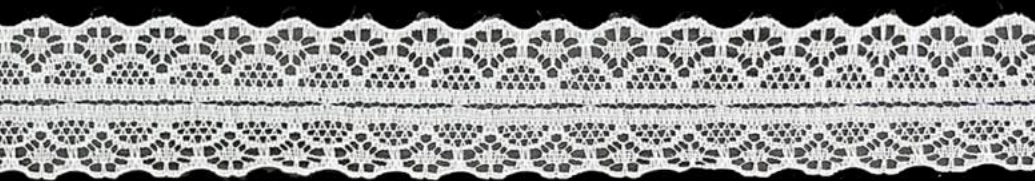

REF.: AR0133-W

CÓDIGO DE BARRA: 7908221682834

PASSAMANARIA

PASSAMANARIA BABADO XADREZ COM ELÁSTICO

1,9 cm X 10 m

NCM: 5808.90.00 IPI: 0%

R\$ 10,30

PREÇO UNIDADE



REF.: AR0055-06

CÓDIGO DE BARRA: 7908221680960



REF.: AR0055-14

CÓDIGO DE BARRA: 7908221680953



REF.: AR0055-40

CÓDIGO DE BARRA: 7908221680915



REF.: AR0055-49

CÓDIGO DE BARRA: 7908221680946



REF.: AR0055-64

CÓDIGO DE BARRA: 7908221680939



REF.: AR0055-66

CÓDIGO DE BARRA: 7908221680977



REF.: AR0055-87

CÓDIGO DE BARRA: 7908221680922



REF.: AR0055-93

CÓDIGO DE BARRA: 7908221681004



REF.: AR0055-96

CÓDIGO DE BARRA: 7908221680984



REF.: AR0055-116

CÓDIGO DE BARRA: 7908221681011



REF.: AR0055-144

CÓDIGO DE BARRA: 7908221681004

PASSAMANARIA

PASSAMANARIA DE FLOR

1,2 cm X 1,5 cm - 15 yd

100% POLIÉSTER

NCM: 5808.90.00 IPI: 0%

R\$ 28,75
PREÇO UNIDADE



REF.: AR0056-1

CÓDIGO DE BARRA: 7908221681028



REF.: AR0056-2

CÓDIGO DE BARRA: 7908221681035



REF.: AR0056-3

CÓDIGO DE BARRA: 7908221681042



REF.: AR0056-4

CÓDIGO DE BARRA: 7908221681059



REF.: AR0056-5

CÓDIGO DE BARRA: 7908221681066



REF.: AR0056-6

CÓDIGO DE BARRA: 7908221681073



REF.: AR0056-7

CÓDIGO DE BARRA: 7908221681080



REF.: AR0056-8

CÓDIGO DE BARRA: 7908221681097



REF.: AR0056-9

CÓDIGO DE BARRA: 7908221681103



REF.: AR0056-10

CÓDIGO DE BARRA: 7908221681110

PASSAMANARIA

PASSAMANARIA DE FLOR

2,5 cm X 15 yd
100% POLIÉSTER
NCM: 5808.90.00 IPI: 0%

R\$ 38,55
PREÇO UNIDADE



REF.: AR0057-1

CÓDIGO DE BARRA: 7908221681127



REF.: AR0057-2

CÓDIGO DE BARRA: 7908221681127



REF.: AR0057-3

CÓDIGO DE BARRA: 7908221681141



REF.: AR0057-4

CÓDIGO DE BARRA: 7908221681158



REF.: AR0057-5

CÓDIGO DE BARRA: 7908221681165



REF.: AR0057-6

CÓDIGO DE BARRA: 7908221681172



REF.: AR0057-7

CÓDIGO DE BARRA: 7908221681189



REF.: AR0057-8

CÓDIGO DE BARRA: 7908221681196



REF.: AR0057-9

CÓDIGO DE BARRA: 7908221681202



REF.: AR0057-10

CÓDIGO DE BARRA: 7908221681219

PASSAMANARIA

PASSAMANARIA DE FLOR

2,5 cm X 15 yd
100% POLIÉSTER
NCM: 5808.90.00 IPI: 0%

R\$ 39,35
PREÇO UNIDADE



REF.: AR0058-1

CÓDIGO DE BARRA: 7908221681226



REF.: AR0058-2

CÓDIGO DE BARRA: 7908221681233



REF.: AR0058-3

CÓDIGO DE BARRA: 7908221681240



REF.: AR0058-4

CÓDIGO DE BARRA: 7908221681257



REF.: AR0058-5

CÓDIGO DE BARRA: 7908221681264



REF.: AR0058-6

CÓDIGO DE BARRA: 7908221681271



REF.: AR0058-7

CÓDIGO DE BARRA: 7908221681288



REF.: AR0058-8

CÓDIGO DE BARRA: 7908221681295



REF.: AR0058-9

CÓDIGO DE BARRA: 7908221681301



REF.: AR0058-10

CÓDIGO DE BARRA: 7908221681318



REF.: AR0058-11

CÓDIGO DE BARRA: 7908221681325

PASSAMANARIA

AR0120

PASSAMANARIA COLORIDA DE FLOR 1,5 cm X 15 yd

100% POLIÉSTER

CÓDIGO DE BARRA: 7908221681332

NCM: 5808.90.00 IPI: 0%

R\$ 35,40

PREÇO UNIDADE



AR0121

PASSAMANARIA COLORIDA 2,3 cm X 15 yd

100% POLIÉSTER

CÓDIGO DE BARRA: 7908221681349

NCM: 5808.90.00 IPI: 0%

R\$ 44,45

PREÇO UNIDADE



AR0122

PASSAMANARIA COLORIDA DE FRUTA 3,8 cm X 15 yd

100% POLIÉSTER

CÓDIGO DE BARRA: 7908221681356

NCM: 5808.90.00 IPI: 0%

R\$ 47,20

PREÇO UNIDADE

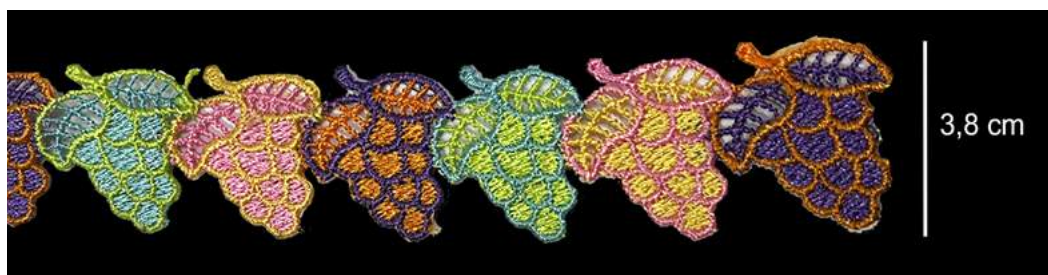

AR0123

PASSAMANARIA COLORIDA DE FLOR - 3,8 cm X 15 yd

100% POLIÉSTER

CÓDIGO DE BARRA: 7908221681363

NCM: 5808.90.00 IPI: 0%

R\$ 47,65

PREÇO UNIDADE

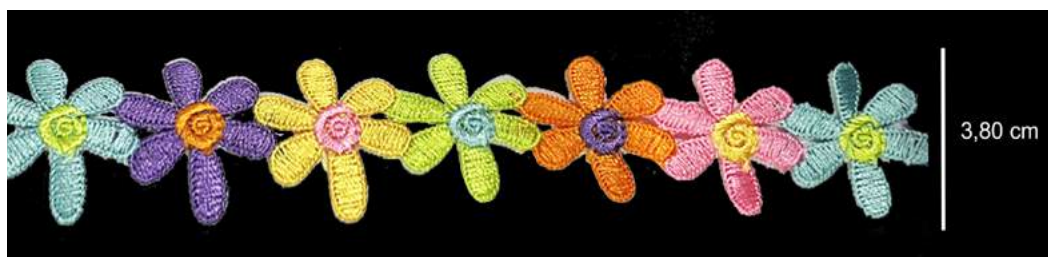

PASSAMANARIA

AR0124

PASSAMANARIA COLORIDA DE FLOR - 1,8 cm X 15 yd

100% POLIÉSTER

CÓDIGO DE BARRA: 7908221681370

NCM: 5808.90.00 IPI: 0%

R\$ 35,40

PREÇO UNIDADE



AR0125

PASSAMANARIA BORBOLETA COLORIDA 2,5 cm X 15 yd

100% POLIÉSTER

CÓDIGO DE BARRA: 7908221681387

NCM: 5808.90.00 IPI: 0%

R\$ 45,25

PREÇO UNIDADE

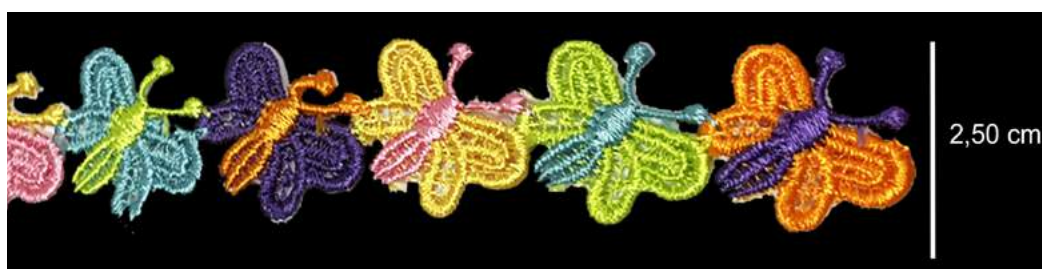

AR0126

PASSAMANARIA COLORIDA DE FRUTA - 2 cm X 15 yd

100% POLIÉSTER

CÓDIGO DE BARRA: 7908221681394

NCM: 5808.90.00 IPI: 0%

R\$ 39,35

PREÇO UNIDADE

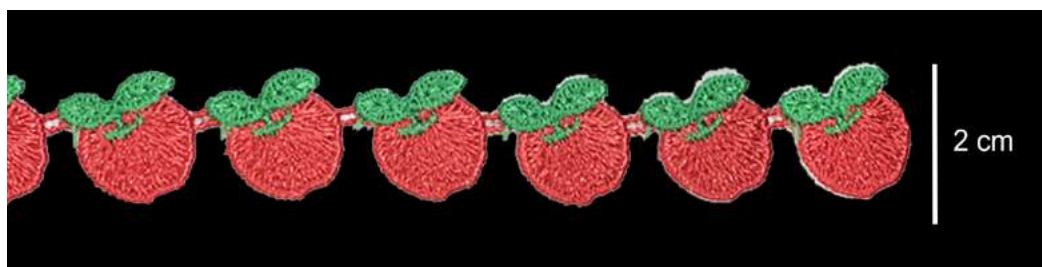

PASSAMANARIA DE FLOR

2 cm X 15 yd

100% POLIÉSTER

NCM: 5808.90.00 IPI: 0%

R\$ 39,35

PREÇO UNIDADE

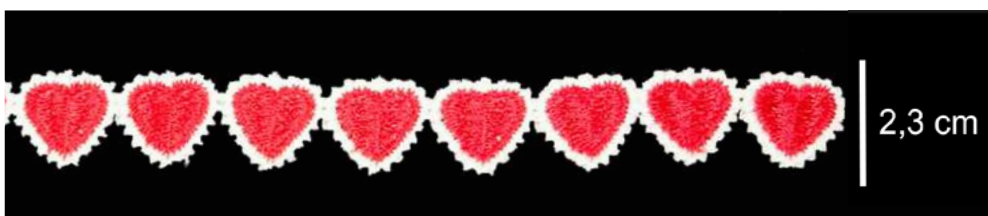

REF: AR0130-1

CÓDIGO DE BARRA: 7908221681561

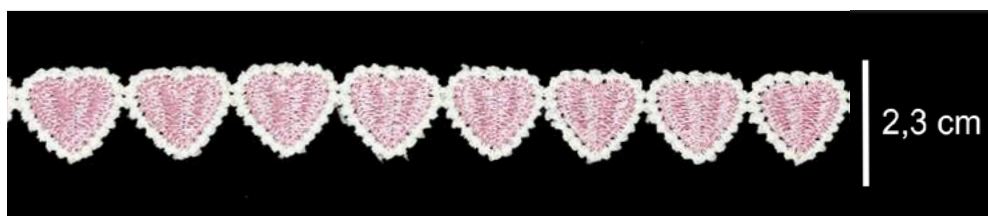

REF: AR0130-2

CÓDIGO DE BARRA: 7908221681578

PASSAMANARIA



REF.: AR0046-1

PASSAMANARIA 1.3CM - 10 JARDAS
CÓDIGO DE BARRA: 7908221657412
NCM: 58089000 IPI: 0%

FRAÇÃO UNIDADE

R\$ 7,50

PREÇO UNIDADE



REF.: AR0046-3

PASSAMANARIA 1.3CM - 10 JARDAS
CÓDIGO DE BARRA: 7908221657436
NCM: 58089000 IPI: 0%

FRAÇÃO UNIDADE

R\$ 7,50

PREÇO UNIDADE



REF.: AR0046-2

PASSAMANARIA 1.3CM - 10 JARDAS
CÓDIGO DE BARRA: 7908221657429
NCM: 58089000 IPI: 0%

FRAÇÃO UNIDADE

R\$ 7,50

PREÇO UNIDADE



REF.: AR0046-4

PASSAMANARIA 1.3CM - 10 JARDAS
CÓDIGO DE BARRA: 7908221657443
NCM: 58089000 IPI: 0%

FRAÇÃO UNIDADE

R\$ 7,50

PREÇO UNIDADE



REF.: AR0046-6

PASSAMANARIA 1.3CM - 10 JARDAS
CÓDIGO DE BARRA: 7908221657467
NCM: 58089000 IPI: 0%

FRAÇÃO UNIDADE

R\$ 7,50

PREÇO UNIDADE



REF.: AR0046-5

PASSAMANARIA 1.3CM - 10 JARDAS
CÓDIGO DE BARRA: 7908221657450
NCM: 58089000 IPI: 0%

FRAÇÃO UNIDADE

R\$ 7,50

PREÇO UNIDADE

PASSAMANARIA

PASSAMANARIA DE FLOR

2 cm X 15 yd

100% POLIÉSTER

NCM: 5808.90.00 IPI: 0%

R\$ 43,30

PREÇO UNIDADE



REF.: AR0127-1

CÓDIGO DE BARRA: 7908221681400



REF.: AR0127-2

CÓDIGO DE BARRA: 7908221681417



REF.: AR0127-3

CÓDIGO DE BARRA: 7908221681424



REF.: AR0127-4

CÓDIGO DE BARRA: 7908221681431



REF.: AR0127-5

CÓDIGO DE BARRA: 7908221681448

PASSAMANARIA DE FLOR

1 cm X 15 yd

100% POLIÉSTER

NCM: 5808.90.00 IPI: 0%

R\$ 55,10

PREÇO UNIDADE



REF.: AR0128-1

CÓDIGO DE BARRA: 7908221681455



REF.: AR0128-2

CÓDIGO DE BARRA: 7908221681462



REF.: AR0128-3

CÓDIGO DE BARRA: 7908221681479



REF.: AR0128-4

CÓDIGO DE BARRA: 7908221681486



REF.: AR0128-5

CÓDIGO DE BARRA: 7908221681493

PASSAMANARIA

PASSAMANARIA DE FLOR

2 cm X 15 yd
100% POLIÉSTER
NCM: 5808.90.00 IPI: 0%

R\$ 39,35
PREÇO UNIDADE

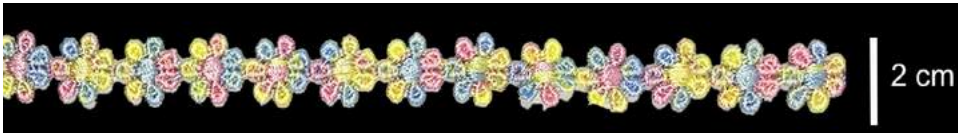

REF.: AR0129-1
CÓDIGO DE BARRA: 7908221681509



REF.: AR0129-2
CÓDIGO DE BARRA: 7908221681516



REF.: AR0129-3
CÓDIGO DE BARRA: 7908221681523



REF.: AR0129-4
CÓDIGO DE BARRA: 7908221681530

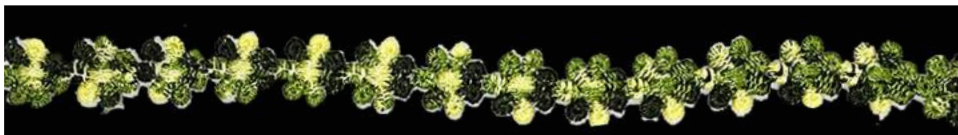

REF.: AR0129-5
CÓDIGO DE BARRA: 7908221681547



REF.: AR0129-6
CÓDIGO DE BARRA: 7908221681554



REF.: AR0035-1
PASSAMANARIA MOEDINHA MOD. 1
3,5 cm X 10 yd
CÓDIGO DE BARRA: 7908221636431
NCM: 9505.90.00 IPI: 13%

R\$ 40,30
PREÇO UNITÁRIO



REF.: AR0035-2
PASSAMANARIA MOEDINHA MOD. 2
4 cm X 10 yd
CÓDIGO DE BARRA: 7908221636448
NCM: 9505.90.00 IPI: 13%

R\$ 44,50
PREÇO UNITÁRIO

PASSAMANARIA



REF.:AR0827-S

PASSAMANARIA PRATEADA

PEÇA 1 CM X 10M

CÓDIGO DE BARRA: 7908221619168

NCM: 5808.90.00 IPI: 0%

FRAÇÃO 12 PEÇAS

R\$ 5,85

PREÇO POR PEÇA



REF.: AR0049-S

PASSAMANARIA PRATEADA

PEÇA 0,9 CM X 10 M

CÓDIGO DE BARRA: 7908221615023

NCM: 5808.90.00 IPI: 0%

FRAÇÃO 12 PEÇAS

R\$ 5,50

PREÇO POR PEÇA



REF.: AR0831-S

PASSAMANARIA PRATA

PEÇA 1,5 CM X 10 M

CÓDIGO DE BARRA: 7908221615016

NCM: 5808.90.00 IPI: 0%

FRAÇÃO 12 PEÇAS

R\$ 4,80

PREÇO POR PEÇA



REF.: AR0045-S

PASSAMANARIA PRATA

PEÇA 2,5 CM * 10M

CÓDIGO DE BARRA: 7908221614958

NCM: 5808.90.00 IPI: 0%

FRAÇÃO 12 PEÇAS

ESGOTADO

PREÇO POR PEÇA



REF.: AR0830-S

PASSAMANARIA PRATA

PEÇA 1,3 CM X 10 M

CÓDIGO DE BARRA: 7908221615047

NCM: 5808.90.00 IPI: 0%

FRAÇÃO 12 PEÇAS

R\$ 5,20

PREÇO POR PEÇA



REF.: AR0047-S

PASSAMANARIA PRATEADA

PEÇA 1,7 CM X 10 M

CÓDIGO DE BARRA: 7908221649813

NCM: 5808.90.00 IPI: 0%

FRAÇÃO 12 PEÇAS

R\$ 5,40

PREÇO POR PEÇA

PASSAMANARIA



REF: AR0036-2

GUIPIR 4,5 CM
APROX. 15 JARDAS - MOD.2
CÓDIGO DE BARRA: 7908221636462
NCM: 5808.90.00 IPI: 0%

FRAÇÃO PACOTE

R\$ 34,50

PREÇO PACOTE



REF.AR0036-3

GUIPIR 4,5 CM -
APROX. 15 JARDAS - MOD.3
CÓDIGO DE BARRA: 7908221636479
NCM: 5808.90.00 IPI: 0%

FRAÇÃO PACOTE

R\$ 34,50

PREÇO PACOTE

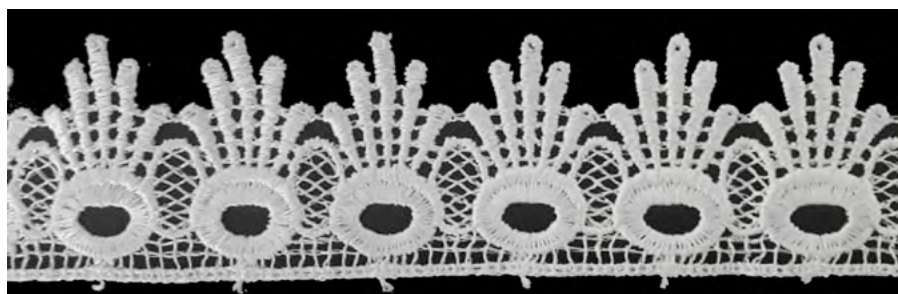

REF:AR0036-1

GUIPIR 4,5 CM
APROX. 15 JARDAS - MOD.1
CÓDIGO DE BARRA:7908221636455
NCM: 5808.90.00 IPI: 0%

FRAÇÃO PACOTE

R\$ 34,50

PREÇO PACOTE



REF: AR0048-4

PASSAMANARIA 5.5CM - 10 JARDAS
CÓDIGO DE BARRA: 7908221657351
NCM: 58089000 IPI: 0%

FRAÇÃO UNIDADE

R\$ 16,90

PREÇO UNIDADE



REF: AR0048-6

PASSAMANARIA 4CM - 10 JARDAS
CÓDIGO DE BARRA: 7908221657375
NCM: 58089000 IPI: 0%

FRAÇÃO UNIDADE

R\$ 16,90

PREÇO UNIDADE



REF: AR0048-7

PASSAMANARIA 5CM - 10 JARDAS
CÓDIGO DE BARRA: 7908221657382
NCM: 58089000 IPI: 0%

FRAÇÃO UNIDADE

R\$ 16,90

PREÇO UNIDADE

GUIPIR / GRIPIR

RENDA GUIPIR / GRIPIR

100 % POLIÉSTER - PEÇA COM 15 yd (jardas)

NCM: 5808.90.00 IPI: 0%

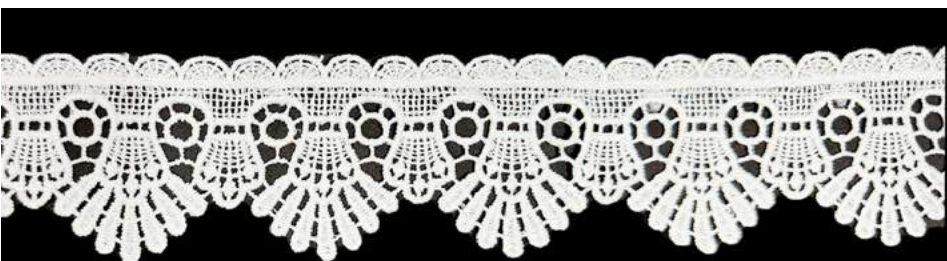

5 cm

REF.: AR0036-4

CÓDIGO DE BARRA: 7908221685729

R\$ 43,80

PREÇO UNIDADE

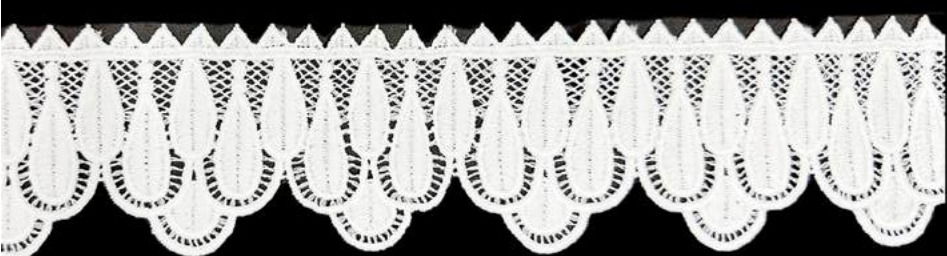

6 cm

REF.: AR0036-5

CÓDIGO DE BARRA: 7908221685736

R\$ 52,15

PREÇO UNIDADE



6 cm

REF.: AR0036-6

CÓDIGO DE BARRA: 7908221669989

R\$ 56,30

PREÇO UNIDADE

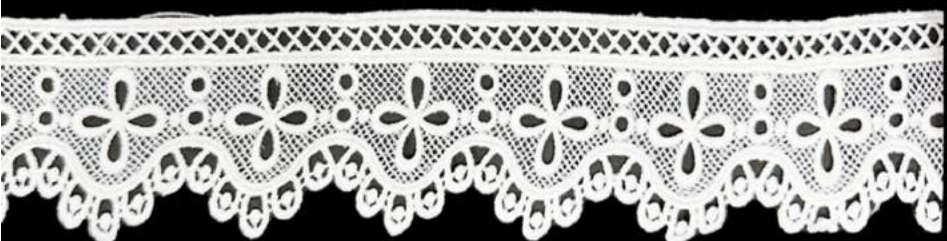

7,5 cm

REF.: AR0036-7

CÓDIGO DE BARRA: 7908221685743

R\$ 47,95

PREÇO UNIDADE



8 cm

REF.: AR0036-8

CÓDIGO DE BARRA: 7908221685750

R\$ 62,55

PREÇO UNIDADE



GUIPIR / GRIPIR

RENDA GUIPIR / GRIPIR

100 % POLIÉSTER - PEÇA COM 15 yd (jardas)

NCM: 5808.90.00 IPI: 0%

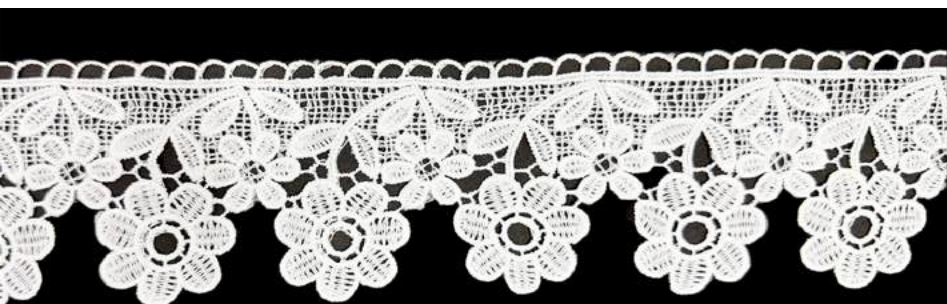

8 cm

REF.: AR0036-9

CÓDIGO DE BARRA: 7908221685767

R\$ 50,05

PREÇO UNIDADE

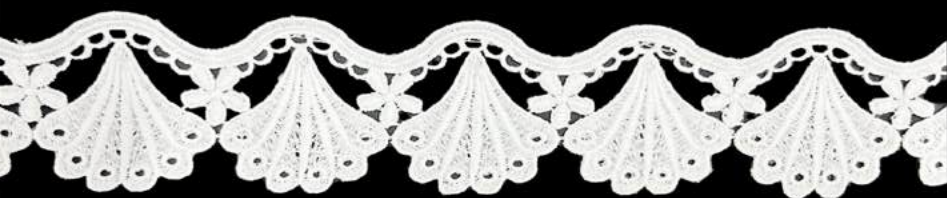

5,8 cm

REF.: AR0036-10

CÓDIGO DE BARRA: 7908221685774

R\$ 58,40

PREÇO UNIDADE



3,6 cm

REF.: AR0036-11

CÓDIGO DE BARRA: 7908221685781

R\$ 44,65

PREÇO UNIDADE



4 cm

REF.: AR0036-12

CÓDIGO DE BARRA: 7908221685798

R\$ 45,90

PREÇO UNIDADE



3 cm

REF.: AR0036-13

CÓDIGO DE BARRA: 7908221685804

R\$ 43,80

PREÇO UNIDADE



4 cm

REF.: AR0036-14

CÓDIGO DE BARRA: 7908221685811

R\$ 37,55

PREÇO UNIDADE



GUIPIR / GRIPIR

RENDA GUIPIR / GRIPIR

100 % POLIÉSTER - PEÇA COM 15 yd (jardas)

NCM: 5808.90.00 IPI: 0%

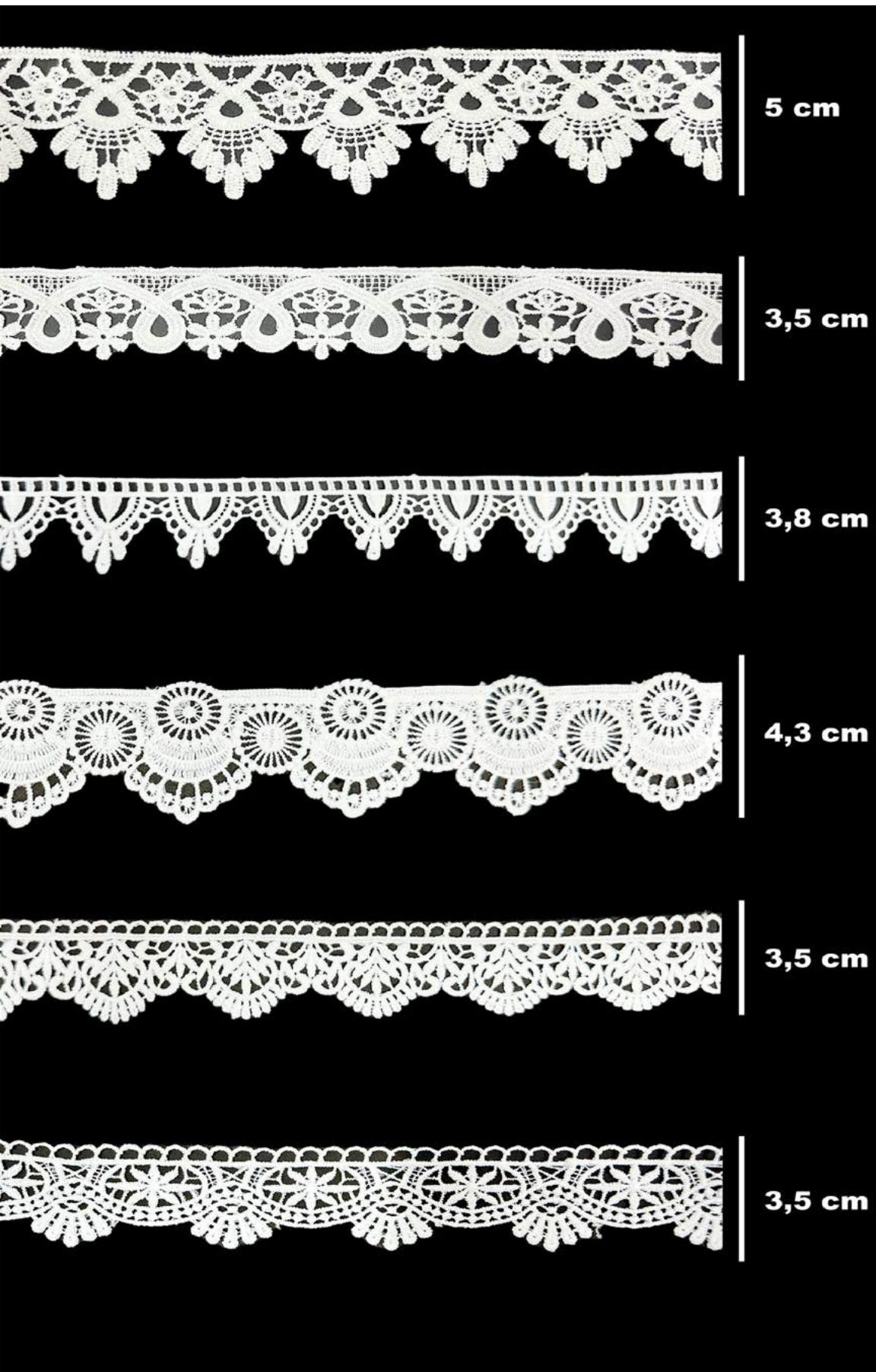

5 cm

REF.: AR0036-15

CÓDIGO DE BARRA: 7908221685828

R\$ 41,70

PREÇO UNIDADE

3,5 cm

REF.: AR0036-16

CÓDIGO DE BARRA: 7908221685835

R\$ 43,80

PREÇO UNIDADE

3,8 cm

REF.: AR0036-17

CÓDIGO DE BARRA: 7908221685842

R\$ 37,55

PREÇO UNIDADE

4,3 cm

REF.: AR0036-18

CÓDIGO DE BARRA: 7908221685859

R\$ 47,95

PREÇO UNIDADE

3,5 cm

REF.: AR0036-19

CÓDIGO DE BARRA: 7908221685866

R\$ 40,45

PREÇO UNIDADE

3,5 cm

REF.: AR0036-20

CÓDIGO DE BARRA: 7908221685873

R\$ 40,45

PREÇO UNIDADE



GUIPIR / GRIPIR

RENDA GUIPIR / GRIPIR

100 % POLIÉSTER - PEÇA COM 15 yd (jardas)

NCM: 5808.90.00 IPI: 0%



3,5 cm

REF: AR0036-21

CÓDIGO DE BARRA: 7908221685880

R\$ 39,65

PREÇO UNIDADE

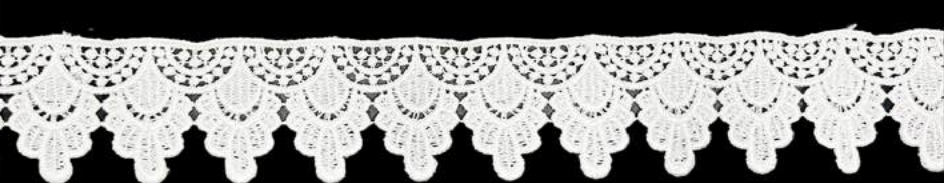

4,5 cm

REF: AR0036-22

CÓDIGO DE BARRA: 7908221685897

R\$ 49,20

PREÇO UNIDADE

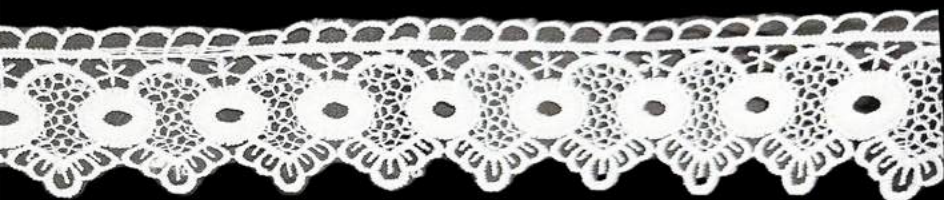

5 cm

REF: AR0036-23

CÓDIGO DE BARRA: 7908221685903

R\$ 41,70

PREÇO UNIDADE



6 cm

REF: AR0036-24

CÓDIGO DE BARRA: 7908221685910

R\$ 57,15

PREÇO UNIDADE

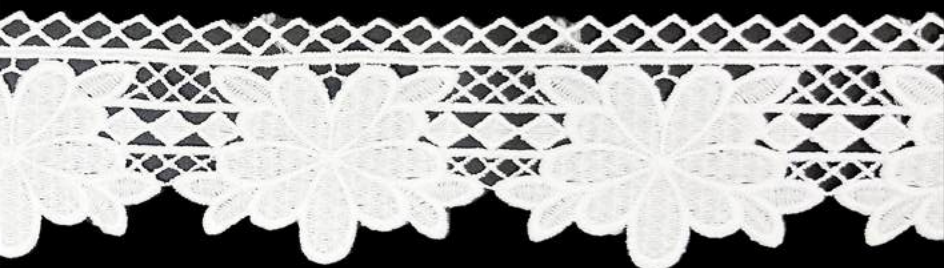

6,5 cm

REF: AR0036-25

CÓDIGO DE BARRA: 7908221685927

R\$ 57,55

PREÇO UNIDADE

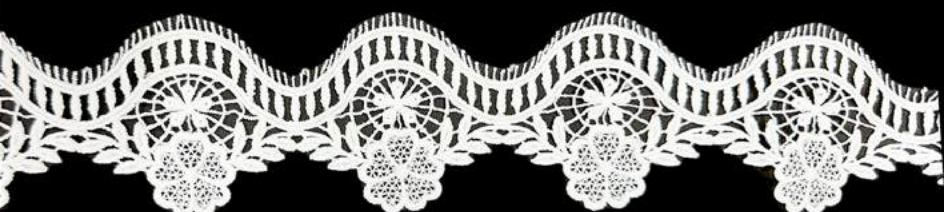

7 cm

REF: AR0036-26

CÓDIGO DE BARRA: 7908221685934

R\$ 57,15

PREÇO UNIDADE



GUIPIR / GRIPIR

RENDA GUIPIR / GRIPIR

100 % POLIÉSTER - PEÇA COM 15 yd (jardas)

NCM: 5808.90.00 IPI: 0%



7 cm

REF.: AR0036-27

CÓDIGO DE BARRA: 7908221685941

R\$ 56,30

PREÇO UNIDADE



6,5 cm

REF.: AR0036-28

CÓDIGO DE BARRA: 7908221685958

R\$ 58,40

PREÇO UNIDADE



7,3 cm

REF.: AR0036-29

CÓDIGO DE BARRA: 7908221685965

R\$ 57,15

PREÇO UNIDADE



6 cm

REF.: AR0036-30

CÓDIGO DE BARRA: 7908221685972

R\$ 58,40

PREÇO UNIDADE



7,8 cm

REF.: AR0036-31

CÓDIGO DE BARRA: 7908221685989

R\$ 60,45

PREÇO UNIDADE



GUIPIR / GRIPIR

RENDA GUIPIR / GRIPIR

100 % POLIÉSTER - PEÇA COM 15 yd (jardas)

NCM: 5808.90.00 IPI: 0%

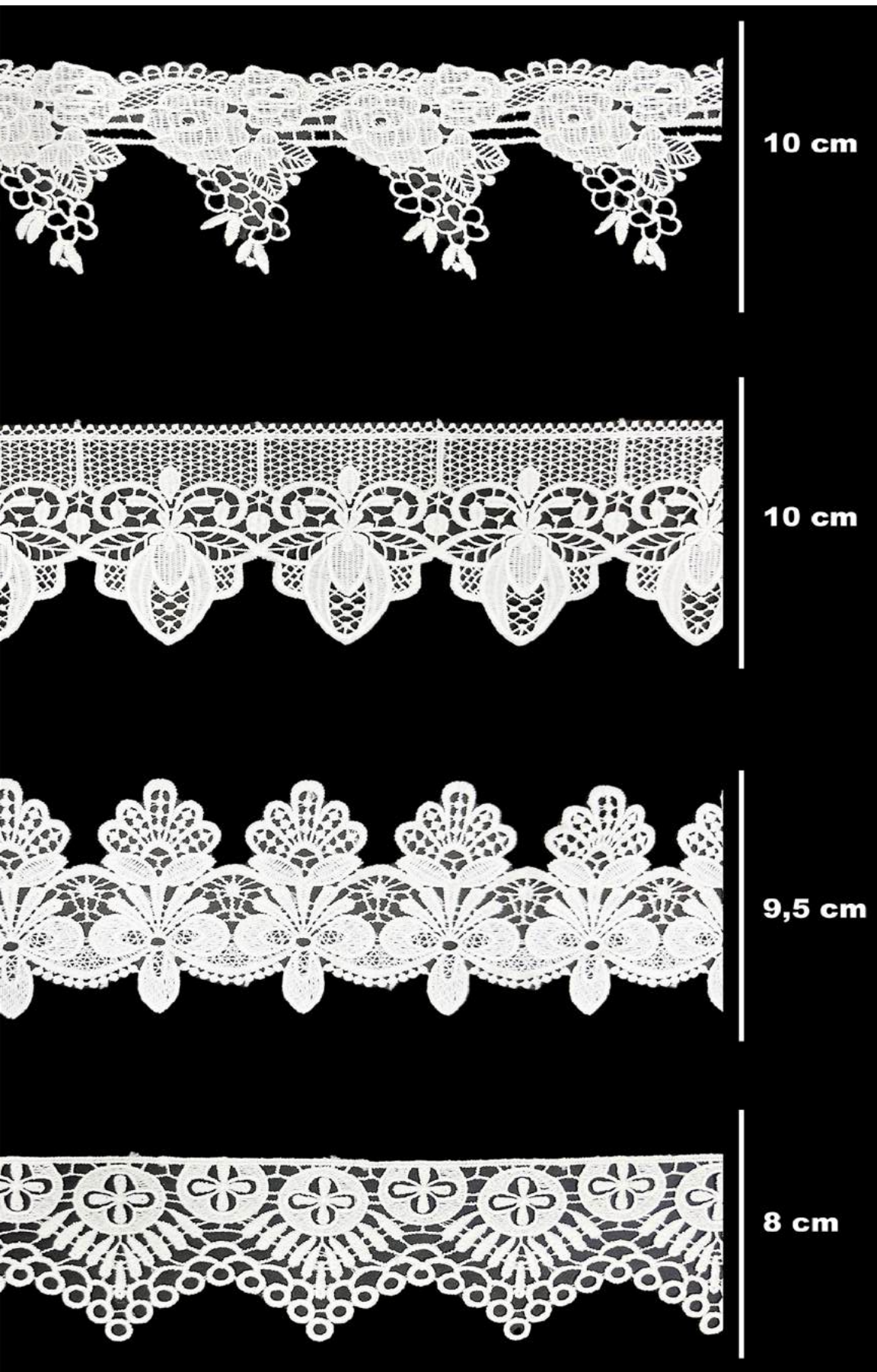

REF.: AR0036-33

CÓDIGO DE BARRA: 7908221686009

R\$ 70,90

PREÇO UNIDADE

REF.: AR0036-34

CÓDIGO DE BARRA: 7908221686016

R\$ 77,15

PREÇO UNIDADE

REF.: AR0036-35

CÓDIGO DE BARRA: 7908221686023

R\$ 73,00

PREÇO UNIDADE

REF.: AR0036-36

CÓDIGO DE BARRA: 7908221686030

R\$ 65,50

PREÇO UNIDADE



GUIPIR / GRIPIR

RENDA GUIPIR / GRIPIR

100 % POLIÉSTER - PEÇA COM 15 yd (jardas)

NCM: 5808.90.00 IPI: 0%

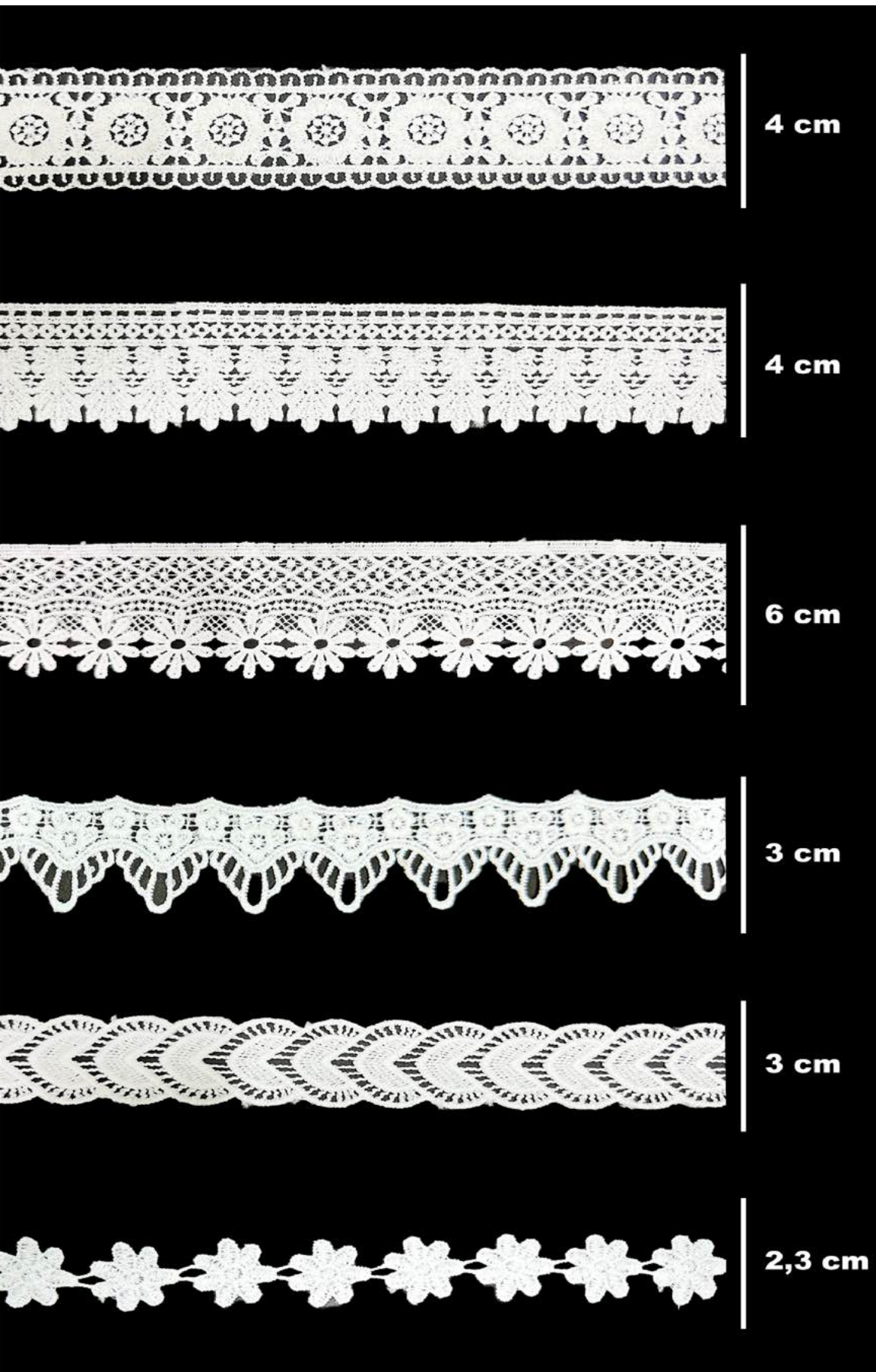

REF.: AR0036-37

CÓDIGO DE BARRA: 7908221686047

R\$ 45,90

PREÇO UNIDADE

REF.: AR0036-38

CÓDIGO DE BARRA: 7908221686054

R\$ 45,90

PREÇO UNIDADE

REF.: AR0036-39

CÓDIGO DE BARRA: 7908221686061

R\$ 56,30

PREÇO UNIDADE

REF.: AR0036-40

CÓDIGO DE BARRA: 7908221686078

R\$ 41,70

PREÇO UNIDADE

REF.: AR0036-41

CÓDIGO DE BARRA: 7908221686085

R\$ 36,70

PREÇO UNIDADE

REF.: AR0036-42

CÓDIGO DE BARRA: 7908221686092

R\$ 25,05

PREÇO UNIDADE



GUIPIR / GRIPIR

RENDA GUIPIR / GRIPIR

100 % POLIÉSTER - PEÇA COM 15 yd (jardas)

NCM: 5808.90.00 IPI: 0%

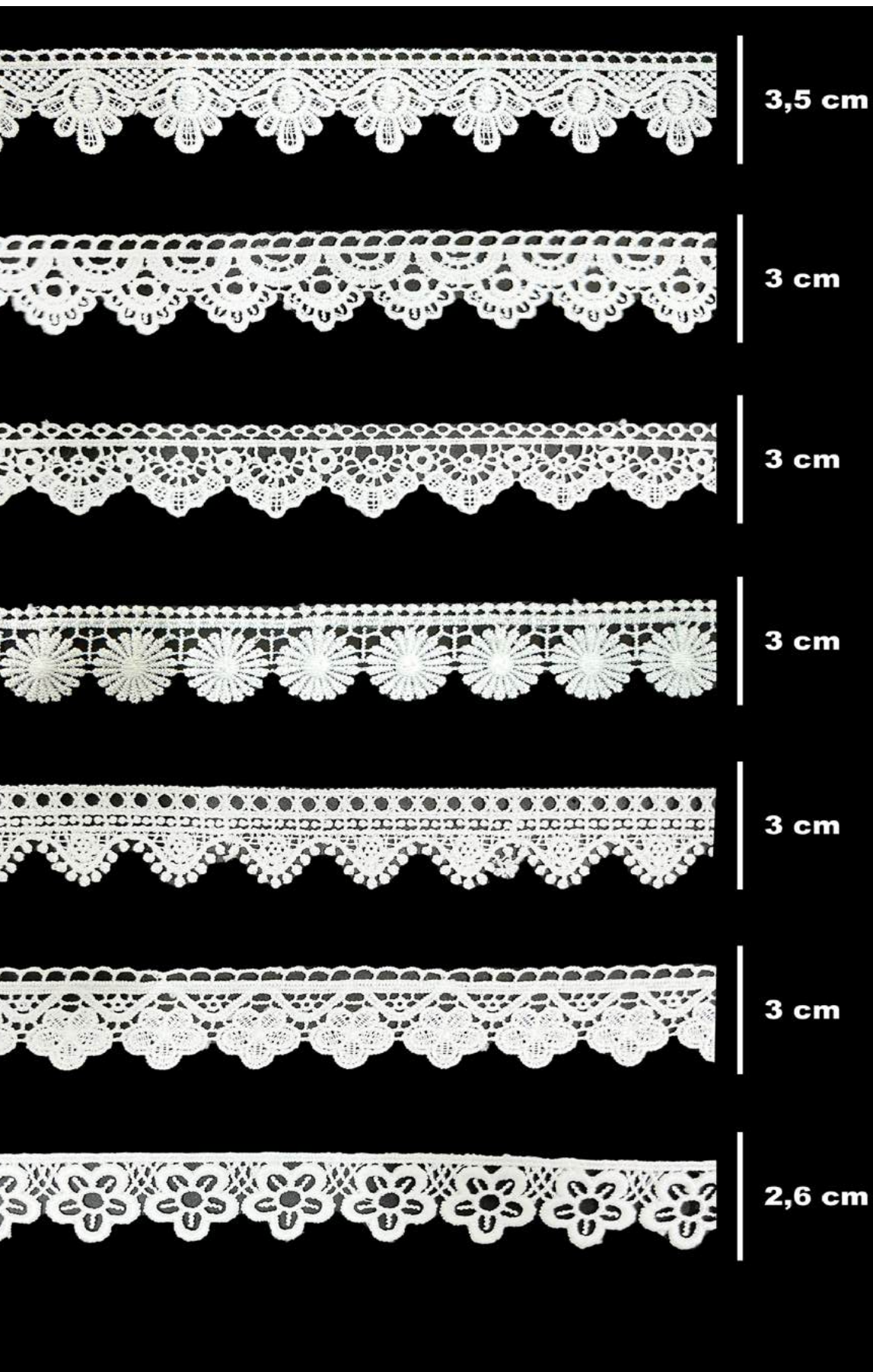

REF.: AR0036-43

CÓDIGO DE BARRA: 7908221686108

R\$ 36,70

PREÇO UNIDADE

REF.: AR0036-44

CÓDIGO DE BARRA: 7908221686115

R\$ 36,70

PREÇO UNIDADE

REF.: AR0036-45

CÓDIGO DE BARRA: 7908221686122

R\$ 36,70

PREÇO UNIDADE

REF.: AR0036-46

CÓDIGO DE BARRA: 7908221686139

R\$ 36,70

PREÇO UNIDADE

REF.: AR0036-47

CÓDIGO DE BARRA: 7908221686146

R\$ 37,55

PREÇO UNIDADE

REF.: AR0036-48

CÓDIGO DE BARRA: 7908221686153

R\$ 39,65

PREÇO UNIDADE

REF.: AR0036-49

CÓDIGO DE BARRA: 7908221686160

R\$ 25,85

PREÇO UNIDADE



GUIPIR / GRIPIR

RENDA GUIPIR / GRIPIR

100 % POLIÉSTER - PEÇA COM 15 yd (jardas)

NCM: 5808.90.00 IPI: 0%

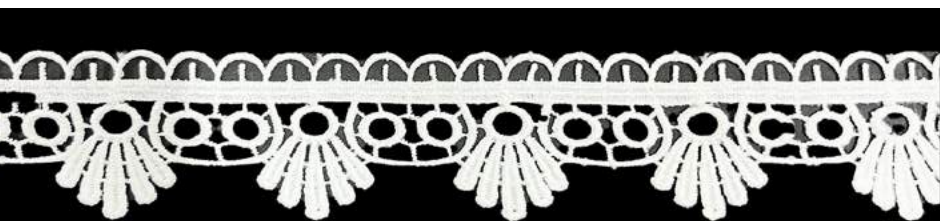

5 cm

REF.: AR0036-50

CÓDIGO DE BARRA: 7908221686177

R\$ 41,70

PREÇO UNIDADE

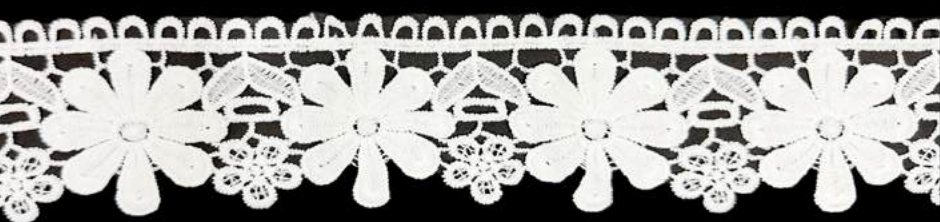

5 cm

REF.: AR0036-51

CÓDIGO DE BARRA: 7908221686184

R\$ 42,95

PREÇO UNIDADE

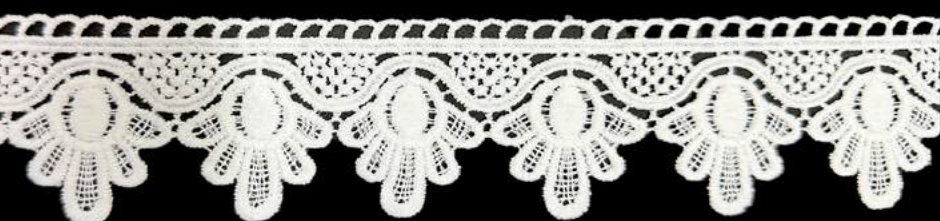

5,5 cm

REF.: AR0036-52

CÓDIGO DE BARRA: 7908221686191

R\$ 41,70

PREÇO UNIDADE



3 cm

REF.: AR0036-53

CÓDIGO DE BARRA: 7908221686207

R\$ 41,70

PREÇO UNIDADE



3 cm

REF.: AR0036-54

CÓDIGO DE BARRA: 7908221686214

R\$ 30,05

PREÇO UNIDADE



2,5 cm

REF.: AR0036-55

CÓDIGO DE BARRA: 7908221686221

R\$ 29,20

PREÇO UNIDADE



1,5 cm

REF.: AR0036-56

CÓDIGO DE BARRA: 7908221686238

R\$ 24,20

PREÇO UNIDADE



BORDADO INGLÊS

BORDADO INGLÊS

100 % ALGODÃO - PEÇA COM 15 yd (jardas)

NCM: 5804.24.10 IPI: 0%

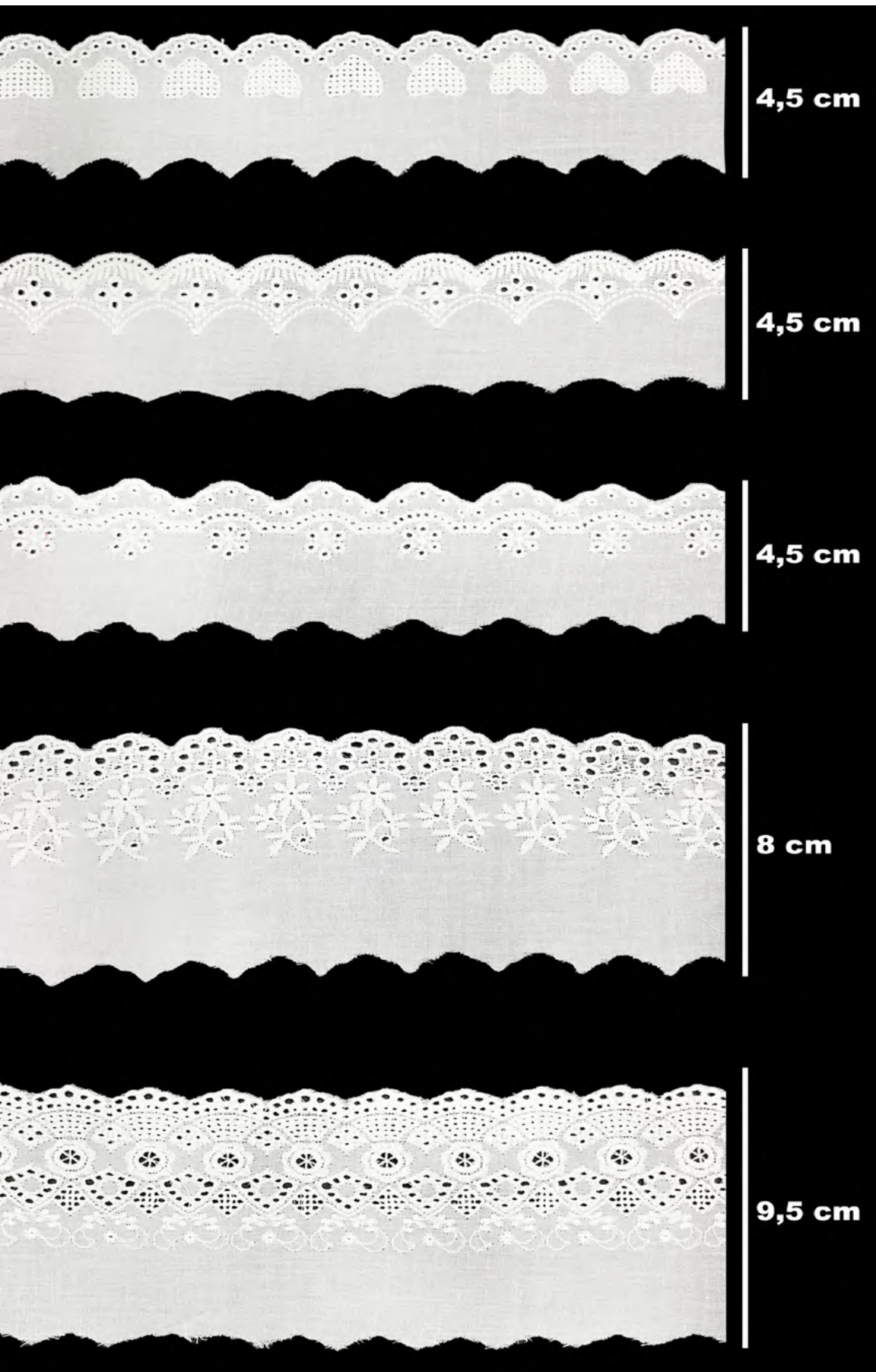

REF.: AR0037-1

CÓDIGO DE BARRA: 7908221686245

R\$ 29,20

PREÇO UNIDADE

REF.: AR0037-2

CÓDIGO DE BARRA: 7908221686252

R\$ 29,20

PREÇO UNIDADE

REF.: AR0037-3

CÓDIGO DE BARRA: 7908221686269

R\$ 30,45

PREÇO UNIDADE

REF.: AR0037-4

CÓDIGO DE BARRA: 7908221686290

R\$ 43,80

PREÇO UNIDADE

REF.: AR0037-5

CÓDIGO DE BARRA: 7908221686306

R\$ 52,15

PREÇO UNIDADE



BORDADO INGLÊS

BORDADO INGLÊS

100 % ALGODÃO - PEÇA COM 15 yd (jardas)

NCM: 5804.24.10 IPI: 0%

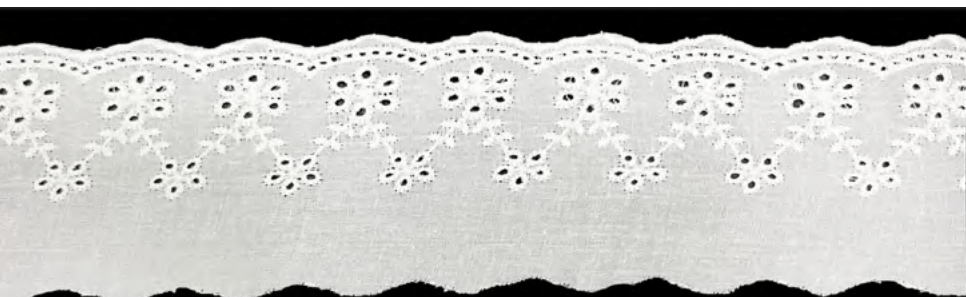

7 cm

REF.: AR0037-6

CÓDIGO DE BARRA: 7908221686313

R\$ 35,45

PREÇO UNIDADE

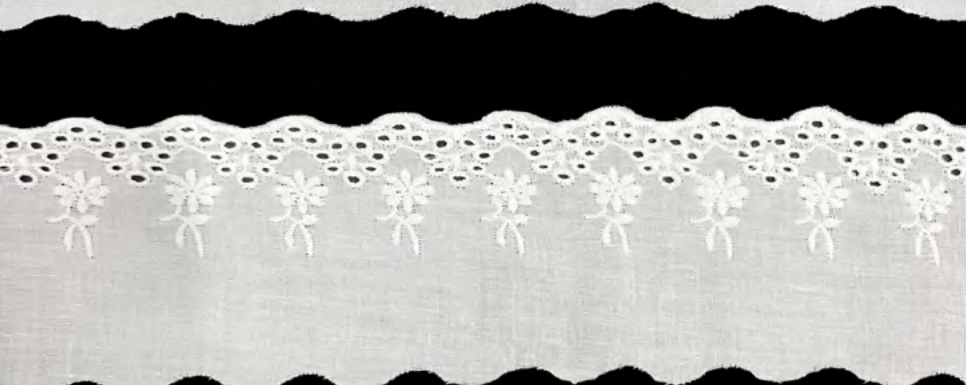

7,5 cm

REF.: AR0037-7

CÓDIGO DE BARRA: 7908221686320

R\$ 33,35

PREÇO UNIDADE

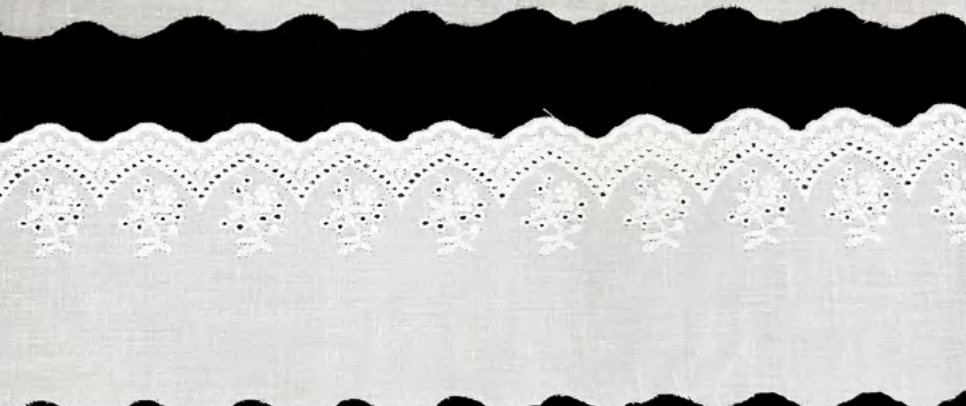

8 cm

REF.: AR0037-8

CÓDIGO DE BARRA: 7908221686337

R\$ 45,90

PREÇO UNIDADE

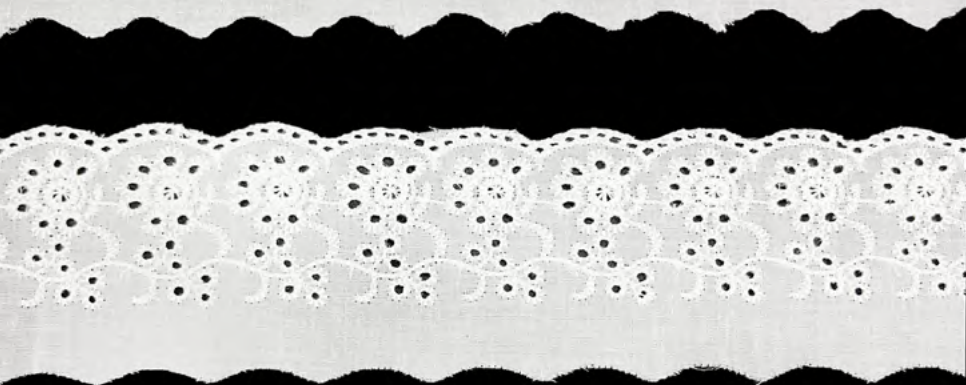

6,5 cm

REF.: AR0037-9

CÓDIGO DE BARRA: 7908221686344

R\$ 52,15

PREÇO UNIDADE

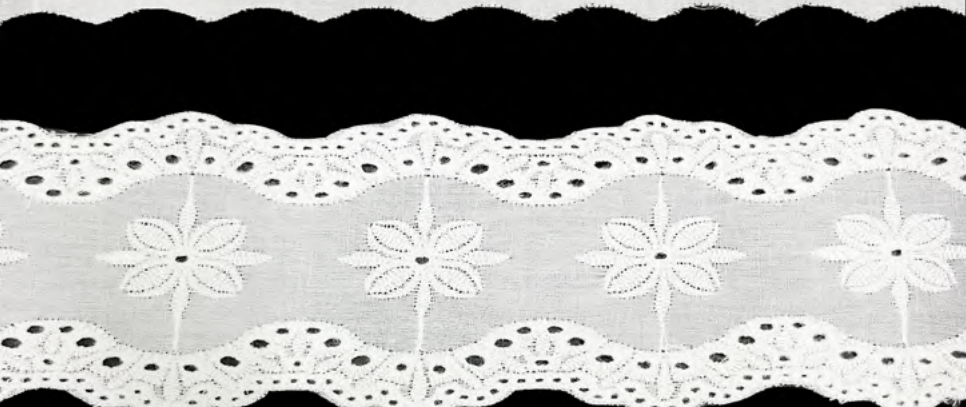

6,5 cm

REF.: AR0037-10

CÓDIGO DE BARRA: 7908221686351

R\$ 79,25

PREÇO UNIDADE



BORDADO INGLÊS

BORDADO INGLÊS

100 % ALGODÃO - PEÇA COM 15 yd (jardas)

NCM: 5804.24.10 IPI: 0%

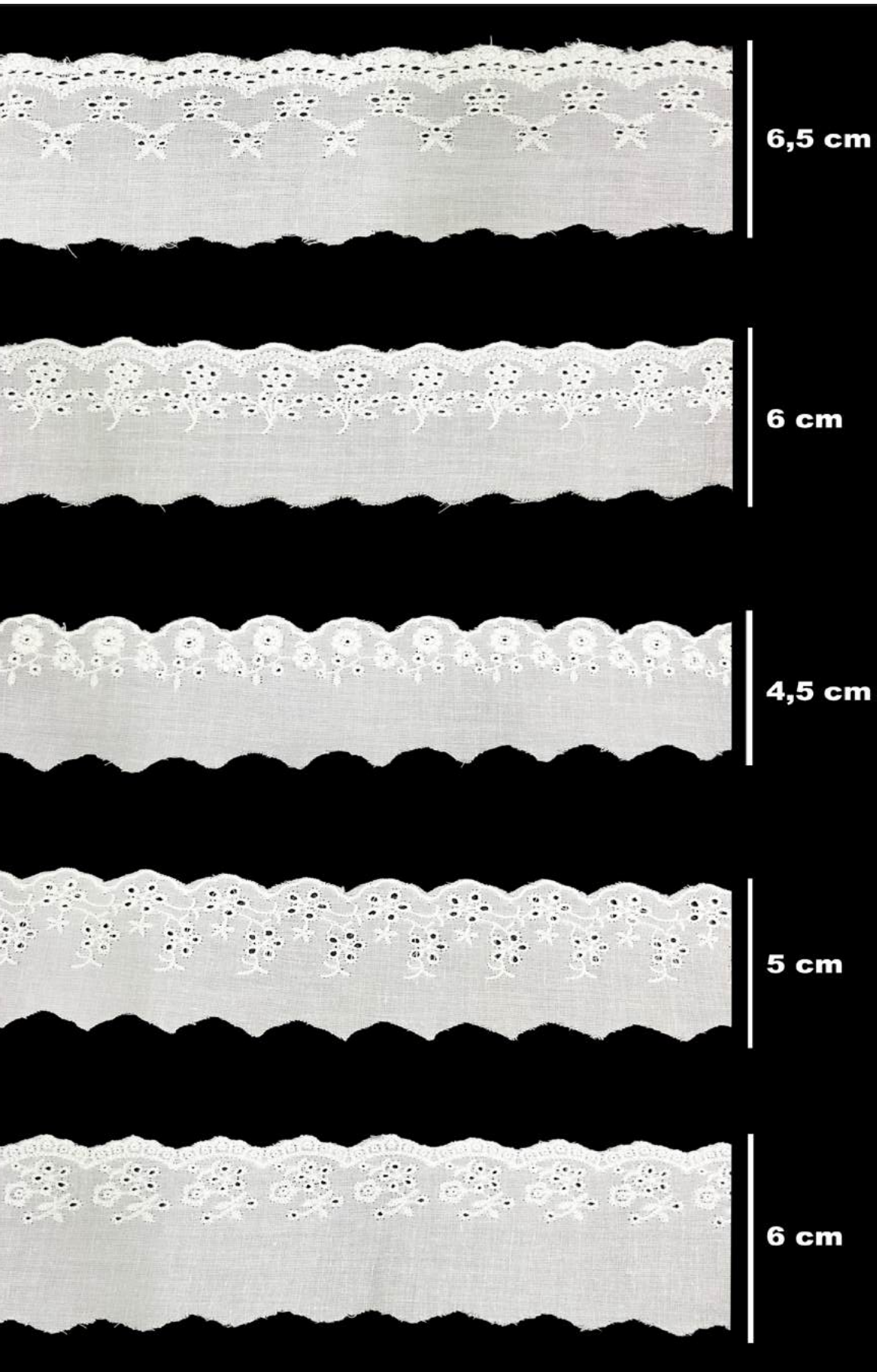

REF.: AR0037-11

CÓDIGO DE BARRA: 7908221686368

R\$ 43,80

PREÇO UNIDADE

REF.: AR0037-12

CÓDIGO DE BARRA: 7908221686375

R\$ 25,05

PREÇO UNIDADE

REF.: AR0037-13

CÓDIGO DE BARRA: 7908221686382

R\$ 28,35

PREÇO UNIDADE

REF.: AR0037-14

CÓDIGO DE BARRA: 7908221686399

R\$ 27,10

PREÇO UNIDADE

REF.: AR0037-15

CÓDIGO DE BARRA: 7908221686405

R\$ 31,30

PREÇO UNIDADE



BORDADO INGLÊS

BORDADO INGLÊS

100 % ALGODÃO - PEÇA COM 15 yd (jardas)

NCM: 5804.24.10 IPI: 0%

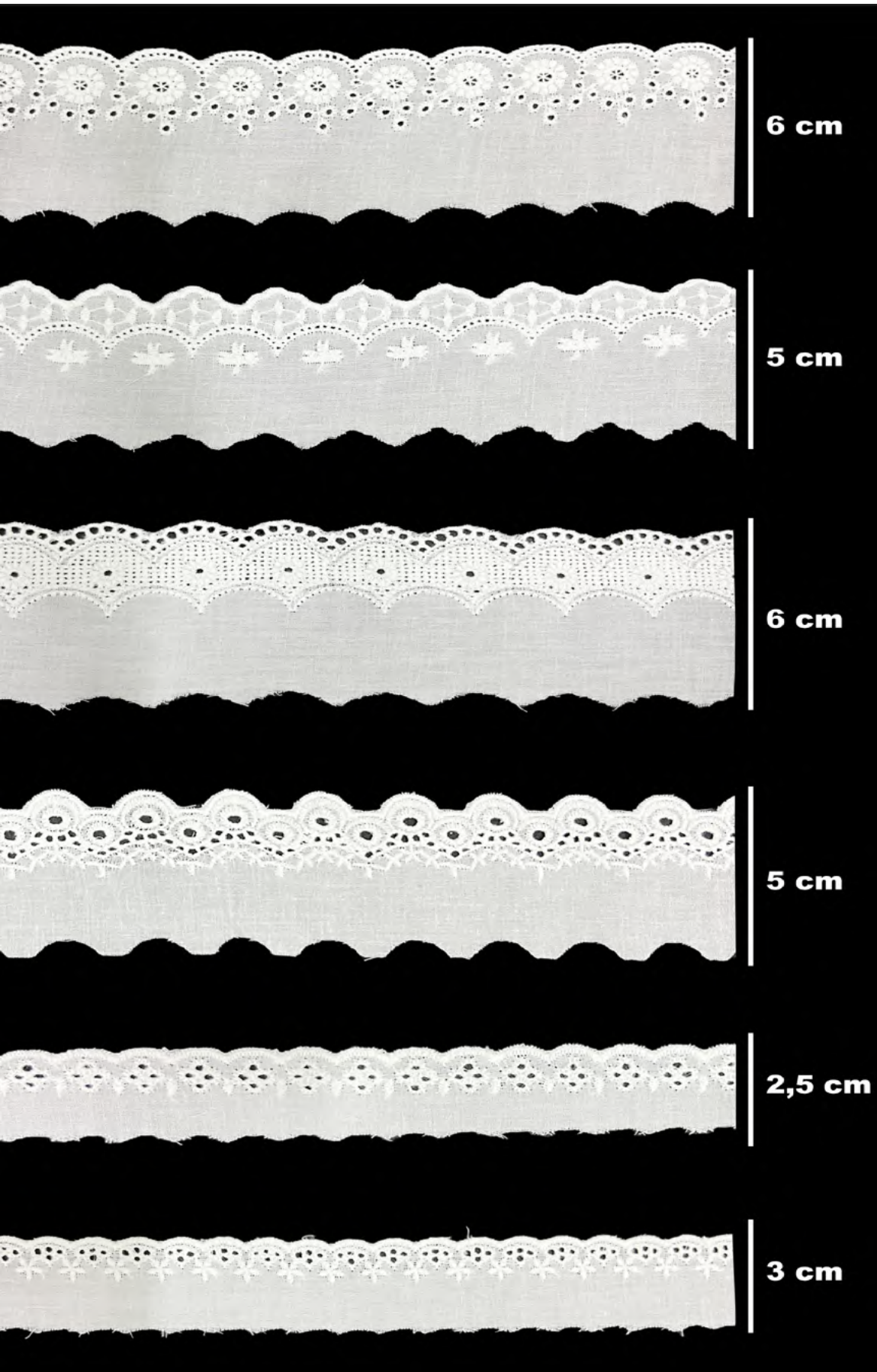

REF.: AR0037-16

CÓDIGO DE BARRA: 7908221686412

R\$ 35,45

PREÇO UNIDADE

REF.: AR0037-17

CÓDIGO DE BARRA: 7908221686429

R\$ 34,60

PREÇO UNIDADE

REF.: AR0037-18

CÓDIGO DE BARRA: 7908221686436

R\$ 35,45

PREÇO UNIDADE

REF.: AR0037-19

CÓDIGO DE BARRA: 7908221686443

R\$ 35,45

PREÇO UNIDADE

REF.: AR0037-20

CÓDIGO DE BARRA: 7908221686450

R\$ 18,80

PREÇO UNIDADE

REF.: AR0037-21

CÓDIGO DE BARRA: 7908221686467

R\$ 25,05

PREÇO UNIDADE



BORDADO INGLÊS

BORDADO INGLÊS

100 % ALGODÃO - PEÇA COM 15 yd (jardas)

NCM: 5804.24.10 IPI: 0%

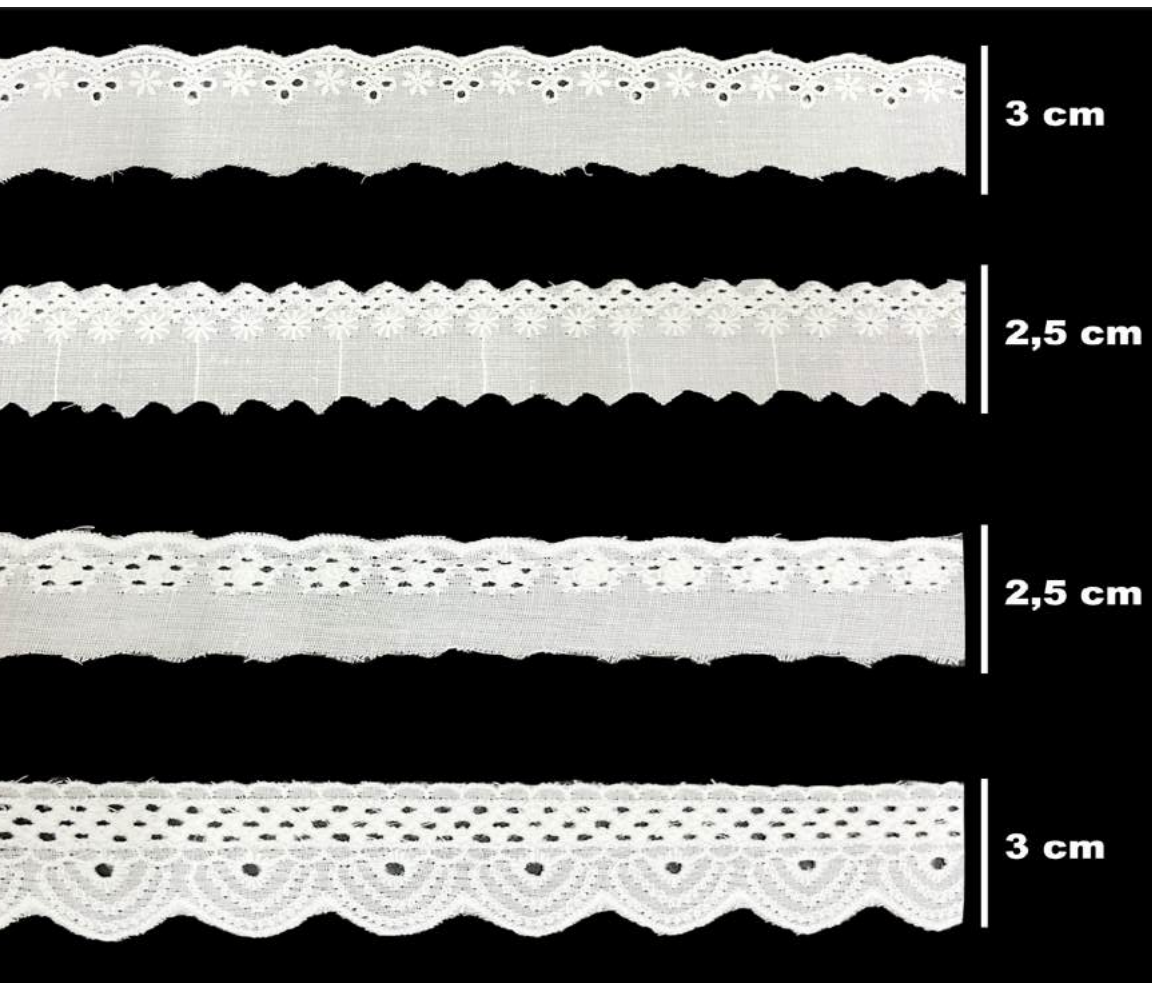

REF.: AR0037-22

CÓDIGO DE BARRA: 7908221686474

R\$ 29,20

PREÇO UNIDADE

REF.: AR0037-23

CÓDIGO DE BARRA: 7908221686481

R\$ 25,05

PREÇO UNIDADE

REF.: AR0037-24

CÓDIGO DE BARRA: 7908221686504

R\$ 14,60

PREÇO UNIDADE

REF.: AR0037-25

CÓDIGO DE BARRA: 7908221686559

R\$ 35,45

PREÇO UNIDADE



BORDADO PASSA FITA

BORDADO PASSA FITA

100 % ALGODÃO - PEÇA COM 15 yd (jardas)

NCM: 5804.24.10 IPI: 0%

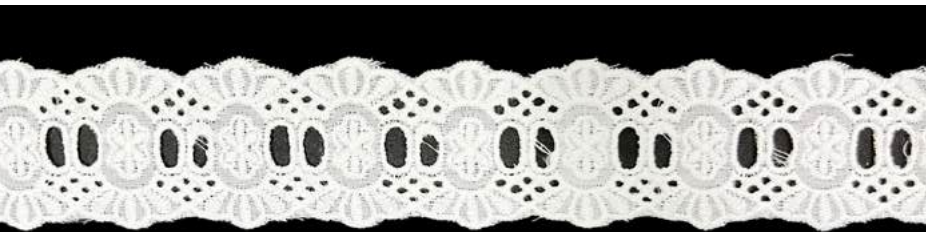

4,5 cm

REF.: AR0038-1

CÓDIGO DE BARRA: 7908221686276

R\$ 47,95

PREÇO UNIDADE

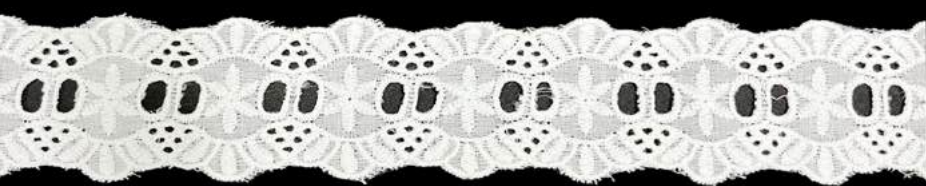

4,5 cm

REF.: AR0038-2

CÓDIGO DE BARRA: 7908221686283

R\$ 47,95

PREÇO UNIDADE

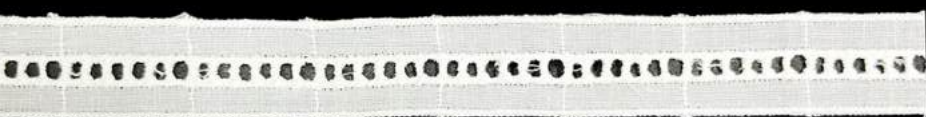

2,5 cm

REF.: AR0038-3

CÓDIGO DE BARRA: 7908221686498

R\$ 27,10

PREÇO UNIDADE



2,2 cm

REF.: AR0038-4

CÓDIGO DE BARRA: 7908221686528

R\$ 35,45

PREÇO UNIDADE



2,5 cm

REF.: AR0038-5

CÓDIGO DE BARRA: 7908221686566

R\$ 37,55

PREÇO UNIDADE

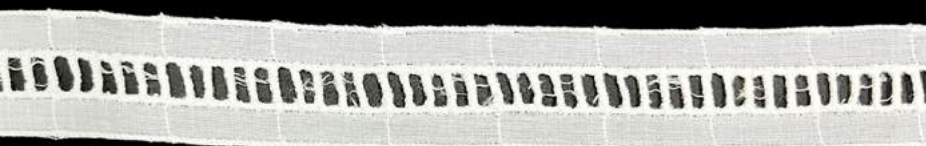

3 cm

REF.: AR0038-6

CÓDIGO DE BARRA: 7908221686573

R\$ 29,20

PREÇO UNIDADE



2,5 cm

REF.: AR0038-7

CÓDIGO DE BARRA: 7908221686580

R\$ 33,35

PREÇO UNIDADE



BORDADO INGLÊS COM PASSA FITA

BORDADO INGLÊS COM PASSA FITA

100 % ALGODÃO - PEÇA COM 15 yd (jardas)

NCM: 5804.24.10 IPI: 0%

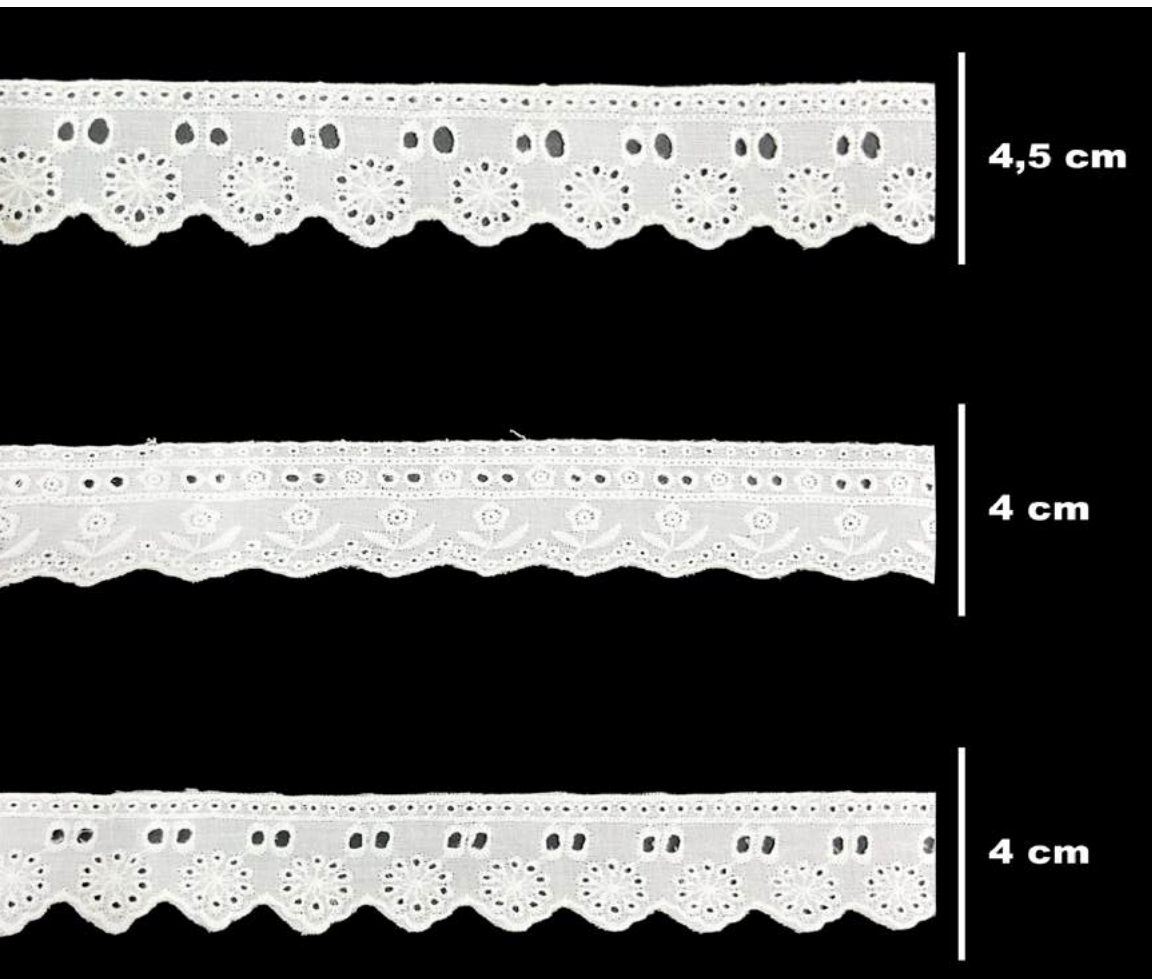

REF.: AR0039-1

CÓDIGO DE BARRA: 7908221686511

R\$ 45,90

PREÇO UNIDADE

REF.: AR0039-2

CÓDIGO DE BARRA: 7908221686535

R\$ 47,95

PREÇO UNIDADE

REF.: AR0039-3

CÓDIGO DE BARRA: 7908221686542

R\$ 47,95

PREÇO UNIDADE



FRANJA DE PENA



FRANJA DE PENA APROX 135 CM X 15 CM

FRAÇÃO UNIDADE

R\$ 25,25

PREÇO POR UNIDADE



REF.: AR0994-R

FRANJA DE PENA COR ROSA
APROX. 135 CM X 15 CM
CÓDIGO DE BARRA: 7908221602979
NCM: 9505.90.00 IPI: 13%



REF.: AR0994-BR

FRANJA DE PENA COR BRANCO
APROX. 135 CM X 15 CM
CÓDIGO DE BARRA: 7908221602917
NCM: 9505.90.00 IPI: 13%



REF.: AR0994-LJ

FRANJA DE PENA COR LARANJA
APROX. 135 CM X 15 CM
CÓDIGO DE BARRA: 7908221602931
NCM: 9505.90.00 IPI: 13%



REF.: AR0994-VD

FRANJA DE PENA COR VERDE
APROX. 135 CM X 15 CM
CÓDIGO DE BARRA: 7908221602955
NCM: 9505.90.00 IPI: 13%



REF.: AR0994-RX

FRANJA DE PENA COR ROXO
APROX. 135 CM X 15 CM
CÓDIGO DE BARRA: 7908221603013
NCM: 9505.90.00 IPI: 13%



REF.: AR0994-VM

FRANJA DE PENA COR VERMELHO
APROX. 135 CM X 15 CM
CÓDIGO DE BARRA: 7908221602924
NCM: 9505.90.00 IPI: 13%



REF.: AR0994-PK

FRANJA DE PENA COR PINK
APROX. 135 CM X 15 CM
CÓDIGO DE BARRA: 7908221602948
NCM: 9505.90.00 IPI: 13%



REF.: AR0994-ÍRIS

FRANJA DE PENA COR ÍRIS
APROX. 135 CM X 15 CM
CÓDIGO DE BARRA: 7908221603006
NCM: 9505.90.00 IPI: 13%

FRANJA DE BOÁ

AR0984 FRANJA DE BOÁ DE PLUMA

Comprimento: 10 m
Largura máxima: 10 cm
NCM: 6308.00.00 IPI: 0%

R\$ 115,30
PREÇO UNITÁRIO



REF.: AR0984-11

CÓDIGO DE BARRA: 7908221680045



REF.: AR0984-13

CÓDIGO DE BARRA: 7908221679995



REF.: AR0984-24

CÓDIGO DE BARRA: 7908221679919



REF.: AR0984-25

CÓDIGO DE BARRA: 7908221680021



REF.: AR0984-34

CÓDIGO DE BARRA: 7908221679940



REF.: AR0984-38

CÓDIGO DE BARRA: 7908221679933

FRANJA DE BOÁ

DICAS DE COMO USAR:



REF.: AR0984-45

CÓDIGO DE BARRA: 7908221679872



REF.: AR0984-46

CÓDIGO DE BARRA: 7908221679957



REF.: AR0984-48

CÓDIGO DE BARRA: 7908221679926



REF.: AR0984-51

CÓDIGO DE BARRA: 7908221679889



REF.: AR0984-53

CÓDIGO DE BARRA: 7908221679971



REF.: AR0984-56

CÓDIGO DE BARRA: 7908221679964

FRANJA DE BOÁ

DICAS DE COMO USAR:



REF.: AR0984-57

CÓDIGO DE BARRA: 7908221680007



REF.: AR0984-59

CÓDIGO DE BARRA: 7908221679988



REF.: AR0984-120

CÓDIGO DE BARRA: 7908221680038



REF.: AR0984-121

CÓDIGO DE BARRA: 7908221680014



REF.: AR0984-16

CÓDIGO DE BARRA: 7908221679902



REF.: AR0984-W

CÓDIGO DE BARRA: 7908221679896

FRANJAS COLORIDAS

FRANJA COLORIDA

10 cm x 10 yd

100% POLIÉSTER

NCM: 6308.00.00 IPI: 0%

R\$ 14,60
PREÇO UNITÁRIO



10 cm x 10 yd



REF.: AR0980-1

CÓDIGO DE BARRA: 7908221679186



REF.: AR0980-3

CÓDIGO DE BARRA: 7908221679193



REF.: AR0980-4

CÓDIGO DE BARRA: 7908221679216



REF.: AR0980-5

CÓDIGO DE BARRA: 7908221679223



REF.: AR0980-6

CÓDIGO DE BARRA: 7908221679230



REF.: AR0980-8

CÓDIGO DE BARRA: 7908221679247



REF.: AR0980-9

CÓDIGO DE BARRA: 7908221679254



REF.: ESGOTADO

CÓDIGO DE BARRA: 7908221679261



REF.: AR0980-11

CÓDIGO DE BARRA: 7908221679209



REF.: AR0980-12

CÓDIGO DE BARRA: 7908221679148



REF.: AR0980-14

CÓDIGO DE BARRA: 7908221679070



REF.: AR0980-15

CÓDIGO DE BARRA: 7908221679087



FRANJAS COLORIDAS



REF.: AR0980-16

CÓDIGO DE BARRA: 7908221679131



REF.: ESGOTADO

CÓDIGO DE BARRA: 7908221679094



REF.: AR0980-22

CÓDIGO DE BARRA: 7908221679100



REF.: AR0980-24

CÓDIGO DE BARRA: 7908221679117



REF.: ESGOTADO

CÓDIGO DE BARRA: 7908221679124



REF.: AR0980-27

CÓDIGO DE BARRA: 7908221679155



REF.: ESGOTADO

CÓDIGO DE BARRA: 7908221679162



REF.: AR0980-33

CÓDIGO DE BARRA: 7908221679179

FRANJAS COLORIDAS

FRANJA COLORIDA

15 cm x 10 yd
100% POLIÉSTER

NCM: 6308.00.00 IPI: 0%

R\$ 18,25
PREÇO UNITÁRIO



15 cm x 10 yd



REF.: AR0981-1

CÓDIGO DE BARRA: 7908221679384



REF.: AR0981-3

CÓDIGO DE BARRA: 7908221679391



REF.: AR0981-4

CÓDIGO DE BARRA: 7908221679414



REF.: AR0981-5

CÓDIGO DE BARRA: 7908221679421



REF.: AR0981-6

CÓDIGO DE BARRA: 7908221679438



REF.: AR0981-8

CÓDIGO DE BARRA: 7908221679445



REF.: AR0981-9

CÓDIGO DE BARRA: 7908221679452



REF.: AR0981-10

CÓDIGO DE BARRA: 7908221679469



REF.: AR0981-11

CÓDIGO DE BARRA: 7908221679407



REF.: AR0981-12

CÓDIGO DE BARRA: 7908221679346



REF.: AR0981-14

CÓDIGO DE BARRA: 7908221679278



REF.: AR0981-15

CÓDIGO DE BARRA: 7908221679285



FRANJAS COLORIDAS



REF.: AR0981-16

CÓDIGO DE BARRA: 7908221679339



REF.: AR0981-18

CÓDIGO DE BARRA: 7908221679292



REF.: AR0981-22

CÓDIGO DE BARRA: 7908221679308



REF.: AR0981-24

CÓDIGO DE BARRA: 7908221679315



REF.: AR0981-25

CÓDIGO DE BARRA: 7908221679322



REF.: AR0981-27

CÓDIGO DE BARRA: 7908221679353



ESGOTADO

CÓDIGO DE BARRA: 7908221679360



REF.: AR0981-33

CÓDIGO DE BARRA: 7908221679377

FRANJAS COLORIDAS

FRANJA COLORIDA

20 cm x 10 yd

100% POLIÉSTER

NCM: 6308.00.00 IPI: 0%

R\$ 25,15
PREÇO UNITÁRIO



20 cm x 10 yd



REF.: AR0982-1

REF.: AR0982-3

REF.: AR0982-4

REF.: AR0982-5

CÓDIGO DE BARRA: 7908221679582

CÓDIGO DE BARRA: 7908221679599

CÓDIGO DE BARRA:

CÓDIGO DE BARRA: 7908221679629



REF.: AR0982-6

REF.: AR0980-8

REF.: AR0982-9

REF.: AR0982-10

CÓDIGO DE BARRA: 7908221679636

CÓDIGO DE BARRA: 7908221679643

CÓDIGO DE BARRA: 7908221679650

CÓDIGO DE BARRA: 7908221679667



REF.: AR0982-11

REF.: AR0982-12

REF.: AR0982-14

REF.: AR0982-15

CÓDIGO DE BARRA: 7908221679605

CÓDIGO DE BARRA: 7908221679544

CÓDIGO DE BARRA: 7908221679476

CÓDIGO DE BARRA: 7908221679483



FRANJAS COLORIDAS



REF.: AR0982-16

CÓDIGO DE BARRA: 7908221679537



REF.: AR0982-18

CÓDIGO DE BARRA: 7908221679490



REF.: AR0982-22

CÓDIGO DE BARRA: 7908221679506



REF.: AR0982-24

CÓDIGO DE BARRA: 7908221679513



REF.: AR0982-25

CÓDIGO DE BARRA: 7908221679520



REF.: AR0982-27

CÓDIGO DE BARRA: 7908221679551



REF.: AR0982-29

CÓDIGO DE BARRA: 7908221679568



REF.: AR0982-33

CÓDIGO DE BARRA: 7908221679575

FRANJAS COLORIDAS

FRANJA COLORIDA

30 cm x 10 yd

100% POLIÉSTER

NCM: 6308.00.00 IPI: 0%

R\$ 39,05
PREÇO UNITÁRIO



30 cm x 10 yd



REF.: AR0983-1

CÓDIGO DE BARRA: 7908221679780



REF.: AR0983-3

CÓDIGO DE BARRA: 7908221679797



REF.: AR0983-4

CÓDIGO DE BARRA: 7908221679810



REF.: AR0983-5

CÓDIGO DE BARRA: 7908221679827



REF.: AR0983-6

CÓDIGO DE BARRA: 7908221679834



REF.: AR0983-8

CÓDIGO DE BARRA: 7908221679841



REF.: AR0983-9

CÓDIGO DE BARRA: 7908221679858



REF.: AR0983-10

CÓDIGO DE BARRA: 7908221679865



REF.: AR0983-11

CÓDIGO DE BARRA: 7908221679803



REF.: AR0983-12

CÓDIGO DE BARRA: 7908221679742



REF.: AR0983-14

CÓDIGO DE BARRA: 7908221679674



REF.: AR0983-15

CÓDIGO DE BARRA: 7908221679681



FRANJAS COLORIDAS



REF.: AR0983-16

CÓDIGO DE BARRA: 7908221679735



REF.: AR0983-18

CÓDIGO DE BARRA: 7908221679698



REF.: AR0983-22

CÓDIGO DE BARRA: 7908221679704



REF.: AR0983-24

CÓDIGO DE BARRA: 7908221679711



REF.: AR0983-25

CÓDIGO DE BARRA: 7908221679728



REF.: AR0983-27

CÓDIGO DE BARRA: 7908221679759



REF.: AR0983-29

CÓDIGO DE BARRA: 7908221679766



REF.: AR0983-33

CÓDIGO DE BARRA: 7908221679773

FRANJA COM BRILHO

FRANJA COM BRILHO DE TECIDO

Largura: 10 yd

NCM: 6308.00.00 IPI: 0%

MODELO 1:

COMPRIMENTO 15 cm X 10 yd

REF.: AR0981-G

FRANJA DOURADA

CÓDIGO DE BARRA: 7908221680793

REF.: AR0981-S

FRANJA PRATA

CÓDIGO DE BARRA: 7908221680786

R\$ 31,20

PREÇO UNITÁRIO



DICAS DE COMO USAR:



FRANJA COM BRILHO

MODELO 2:

COMPRIMENTO 20 cm X 10 yd

REF.: AR0982-G

FRANJA DOURADA

CÓDIGO DE BARRA: 7908221680816

REF.: AR0982-S

FRANJA PRATA

CÓDIGO DE BARRA: 7908221680809

R\$ 43,65

PREÇO UNITÁRIO



MODELO 3:

COMPRIMENTO 30 cm X 10 yd

REF.: AR0983-G

FRANJA DOURADA

CÓDIGO DE BARRA: 7908221680823

REF.: AR0983-S

FRANJA PRATA

CÓDIGO DE BARRA: 7908221680809

R\$ 99,75

PREÇO UNITÁRIO



FRANJAS METÁLICAS

FRANJA METÁLICA

15 cm x 10 m

100% P.E.T

NCM: 3921.90.90 IPI: 9,75%

R\$ 36,15
PREÇO UNITÁRIO



REF.: AR0986-G

CÓDIGO DE BARRA: 7908221682087



REF.: AR0986-S

CÓDIGO DE BARRA: 7908221682094



REF.: ESGOTADO

CÓDIGO DE BARRA: 7908221682070



REF.: AR0986-M21

CÓDIGO DE BARRA: 7908221682100



REF.: AR0986-M27

CÓDIGO DE BARRA: 7908221682117



REF.: AR0986-M35

CÓDIGO DE BARRA: 7908221682124



REF.: AR0986-M36

CÓDIGO DE BARRA: 7908221682131



REF.: AR0986-M37

CÓDIGO DE BARRA: 7908221682148



REF.: AR0986-M41

CÓDIGO DE BARRA: 7908221682155



REF.: AR0986-M53

CÓDIGO DE BARRA: 7908221682162



REF.: AR0986-M53-1

CÓDIGO DE BARRA: 7908221682179

FRANJAS METÁLICAS

FRANJA METÁLICA

20 cm x 10 m

100% P.E.T

NCM: 3921.90.90 IPI: 9,75%

R\$ 50,05
PREÇO UNITÁRIO



REF.: AR0987-G

CÓDIGO DE BARRA: 7908221682193



REF.: AR0987-S

CÓDIGO DE BARRA: 7908221682209



REF.: AR0987-M19

CÓDIGO DE BARRA: 7908221682186



REF.: AR0987-M21

CÓDIGO DE BARRA: 7908221682216



REF.: AR0987-M27

CÓDIGO DE BARRA: 7908221682223



REF.: AR0987-M35

CÓDIGO DE BARRA: 7908221682230



REF.: AR0987-M36

CÓDIGO DE BARRA: 7908221682247



REF.: AR0987-M37

CÓDIGO DE BARRA: 7908221682254



REF.: AR0987-M41

CÓDIGO DE BARRA: 7908221682261



REF.: AR0987-M53

CÓDIGO DE BARRA: 7908221682278



REF.: AR0987-M53-1

CÓDIGO DE BARRA: 7908221682285

FRANJA DE LANTEJOULA

AR0985 FRANJA DE LANTEJOULA

Comprimento: 10 m

Largura da franja: 20 cm

NCM: 6308.00.00 IPI: 0%

R\$ 49,90

PREÇO UNITÁRIO



FRANJA COM LANTEJOULA
COMPRIMENTO: 10 yd
LARGURA DA FRANJA: 20 cm



DICAS DE COMO USAR:



REF.: AR0985-1

CÓDIGO DE BARRA: 7908221680113



REF.: AR0985-2

CÓDIGO DE BARRA: 7908221680120



REF.: AR0985-3

CÓDIGO DE BARRA: 7908221680137



REF.: AR0985-4

CÓDIGO DE BARRA: 7908221680144



REF.: AR0985-6

CÓDIGO DE BARRA: 7908221680151



REF.: AR0985-8

CÓDIGO DE BARRA: 7908221680182

FRANJA DE LANTEJOULA



REF.: AR0985-9

CÓDIGO DE BARRA: 7908221680199



REF.: AR0985-10

CÓDIGO DE BARRA: 7908221680205



REF.: AR0985-13

CÓDIGO DE BARRA: 7908221680212



REF.: AR0985-23

CÓDIGO DE BARRA: 7908221680168



REF.: AR0985-24

CÓDIGO DE BARRA: 7908221680083



REF.: AR0985-26

CÓDIGO DE BARRA: 7908221680090



REF.: AR0985-28

CÓDIGO DE BARRA: 7908221680106



REF.: AR0985-29

CÓDIGO DE BARRA: 7908221680069



REF.: AR0985-31

CÓDIGO DE BARRA: 7908221680175



REF.: AR0985-34

CÓDIGO DE BARRA: 7908221680250

FRANJA DE LANTEJOULA

AR0985 FRANJA DE LANTEJOULA

Comprimento: 10 m

Largura da franja: 20 cm

NCM: 6308.00.00 IPI: 0%

R\$ 49,90

PREÇO UNITÁRIO



REF.: AR0985-17

CÓDIGO DE BARRA: 7908221680052



REF.: AR0985-33

CÓDIGO DE BARRA: 7908221680243



REF.: AR0985-15

CÓDIGO DE BARRA: 7908221680229



REF.: AR0985-18

CÓDIGO DE BARRA: 7908221680076



REF.: AR0985-32

CÓDIGO DE BARRA: 7908221680236

PAETÊS

PAETÊ REDONDO

TAMANHO: 25 mm
PACOTE COM 500 g
NCM: 3926.90.90 IPI: 9,75%

R\$ 29,50

PREÇO PACOTE

***UM FURO POR PAÊTE**



ESGOTADO

CÓDIGO DE BARRA: 7908221692321



ESGOTADO

CÓDIGO DE BARRA: 7908221692338



REF.: AR1020-3

CÓDIGO DE BARRA: 7908221692376



REF.: AR1020-4

CÓDIGO DE BARRA: 7908221692437



REF.: AR1020-A5

CÓDIGO DE BARRA: 7908221692727



ESGOTADO

CÓDIGO DE BARRA: 7908221692369

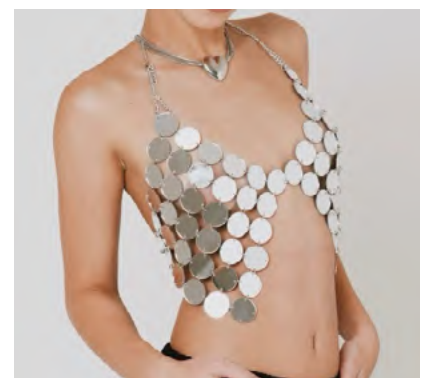

PAETÊS



REF.: AR1020-10

CÓDIGO DE BARRA: 7908221692420



REF.: AR1020-11

CÓDIGO DE BARRA: 7908221692444



REF.: AR1020-13

CÓDIGO DE BARRA: 7908221692345



REF.: AR1020-M18

CÓDIGO DE BARRA: 7908221692352



REF.: AR1020-26A

CÓDIGO DE BARRA: 7908221692451



REF.: AR1020-M39

CÓDIGO DE BARRA: 7908221692390



REF.: AR1020-M101

CÓDIGO DE BARRA: 7908221692468



REF.: AR1020-338

CÓDIGO DE BARRA: 7908221692406



REF.: AR1020-2253

CÓDIGO DE BARRA: 7908221692383



REF.: AR1020-2259

CÓDIGO DE BARRA: 7908221692413

PAETÊS

PAETÊ REDONDO HOLOGRÁFICO

TAMANHO: 25 mm
PACOTE COM 500 g

NCM: 3926.90.90 IPI: 9,75%

R\$ 29,50

PREÇO PACOTE

***UM FURO POR PAÊTE**



REF.: AR1020-A10

CÓDIGO DE BARRA: 7908221692536



REF.: AR1020-M11

CÓDIGO DE BARRA: 7908221692475

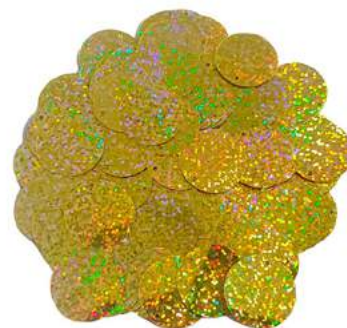

REF.: AR1020-A20

CÓDIGO DE BARRA: 7908221692505



REF.: AR1020-A30

CÓDIGO DE BARRA: 7908221692574



REF.: AR1020-A70

CÓDIGO DE BARRA: 7908221692543



REF.: AR1020-A79

CÓDIGO DE BARRA: 7908221692550



PAETÊS

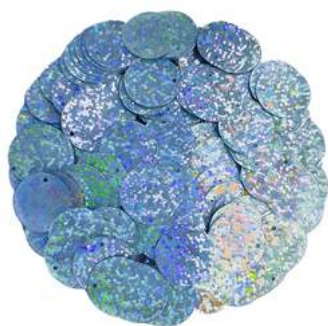

REF.: AR1020-A88

CÓDIGO DE BARRA: 7908221692611



REF.: AR1020-A95

CÓDIGO DE BARRA: 7908221692512



REF.: AR1020-A96

CÓDIGO DE BARRA: 7908221693175



REF.: AR1020-A109

CÓDIGO DE BARRA: 7908221692567



REF.: AR1020-50101

CÓDIGO DE BARRA: 7908221692598

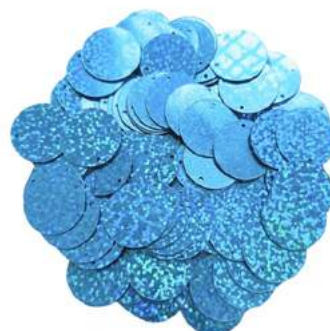

REF.: AR1020-50102

CÓDIGO DE BARRA: 7908221692604



REF.: AR1020-50103

CÓDIGO DE BARRA: 7908221692482



REF.: AR1020-50104

CÓDIGO DE BARRA: 7908221692529



REF.: AR1020-50108

CÓDIGO DE BARRA: 7908221692499



REF.: AR1020-50112

CÓDIGO DE BARRA: 7908221692628



REF.: AR1020-5050126

CÓDIGO DE BARRA: 7908221692581

APLIQUES DIVERSOS

REF.: AR0100-1

MINI TOUCA DE TRICÔ - 35 mm X 35 mm

CÓD.BARRA: 7908221666551

NCM: 63079090 IPI: 0%

FRAÇÃO PACOTE 100 UND

R\$ 41,55

PREÇO PACOTE



OUTRAS CORES:



REF.: AR0100-2

MINI TOUCA DE TRICÔ

35 mm X 35 mm

CÓD.BARRA: 7908221666568

NCM: 63079090 IPI: 0%



REF. AR0100-3

MINI TOUCA DE TRICÔ

35 mm X 35 mm

CÓD.BARRA: 7908221666575

NCM: 63079090 IPI: 0%



REF.: AR0100-4

MINI TOUCA DE TRICÔ

35 mm X 35 mm

CÓD.BARRA: 7908221666582

NCM: 63079090 IPI: 0%



REF.: AR0100-5

MINI TOUCA DE TRICÔ

35 mm X 35 mm

CÓD.BARRA: 7908221666599

NCM: 63079090 IPI: 0%



REF.: AR0100-6

MINI TOUCA DE TRICÔ

35 mm X 35 mm

CÓD.BARRA: 7908221666605

NCM: 63079090 IPI: 0%



REF.: AR0100-7

MINI TOUCA DE TRICÔ

35 mm X 35 mm

CÓD.BARRA: 7908221666612

NCM: 63079090 IPI: 0%



REF.: AR0100-8

MINI TOUCA DE TRICÔ

35 mm X 35 mm

CÓD.BARRA: 7908221666629

NCM: 63079090 IPI: 0%



REF.: AR0100-9

MINI TOUCA DE TRICÔ

35 mm X 35 mm

CÓD.BARRA: 7908221666636

NCM: 63079090 IPI: 0%



REF.: AR0100-10

MINI TOUCA DE TRICÔ

35 mm X 35 mm

CÓD.BARRA: 7908221666643

NCM: 63079090 IPI: 0%



REF.: AR0100-11

MINI TOUCA DE TRICÔ

35 mm X 35 mm

CÓD.BARRA: 7908221666506

NCM: 63079090 IPI: 0%

APLIQUE DE LAÇO

APLIQUE LAÇO DE VOAL - 1 cm

PACOTE COM 100 UNIDADES

NCM: 6307.90.90 IPI: 0%

R\$ 14,05
PREÇO PACOTE



REF.: AR1015-1

CÓDIGO DE BARRA: 7908221683367

REF.: AR1015-2

CÓDIGO DE BARRA: 7908221683404

REF.: AR1015-3

CÓDIGO DE BARRA: 7908221683374



REF.: AR1015-4

CÓDIGO DE BARRA: 7908221683411

REF.: AR1015-5

CÓDIGO DE BARRA: 7908221683381

REF.: AR1015-7

CÓDIGO DE BARRA: 7908221683329



REF.: AR1015-8

CÓDIGO DE BARRA: 7908221683336

REF.: AR1015-9

CÓDIGO DE BARRA: 7908221683398

REF.: AR1015-10

CÓDIGO DE BARRA: 7908221683343



REF.: AR1015-11

CÓDIGO DE BARRA: 7908221683350

REF.: AR1015-12

CÓDIGO DE BARRA: 7908221683428

APLICAÇÃO DE FLOR

FLOR DE VOAL PARA APLICAÇÃO

TAMANHO: 6 cm

PACOTE COM 50 UNIDADES

NCM: 9505.90.00 IPI: 13%

FRAÇÃO PACOTE COM 50 UND

R\$ 27,80

PREÇO PACOTE



REF.:AR1012-1

CÓDIGO DE BARRA: 7908221680267



REF.:AR1012-2

CÓDIGO DE BARRA: 7908221680274



REF.:AR1012-3

CÓDIGO DE BARRA: 7908221680281

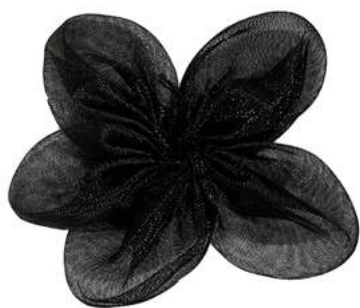

REF.:AR1012-4

CÓDIGO DE BARRA: 7908221680298



REF.:AR1012-5

CÓDIGO DE BARRA: 7908221680304

APLICAÇÃO DE FLOR

FLOR PARA APLICAÇÃO - 6,5 cm

PACOTE COM 50 UNIDADES

100% POLIÉSTER

NCM: 5808.90.00 IPI: 0%

R\$ 26,25

PREÇO PACOTE



REF.: AR1011-W

CÓD.BARRA: 7908221680588



REF.: AR1011-1

CÓD.BARRA: 7908221680526



REF.: AR1011-5

CÓD.BARRA: 7908221680540



REF.: AR1011-33

CÓD.BARRA: 7908221680571



REF.: AR1011-8

CÓD.BARRA: 7908221680533



REF.: AR1011-10

CÓD.BARRA: 7908221680656



REF.: AR1011-12

CÓD.BARRA: 7908221680557



REF.: AR1011-48

CÓD.BARRA: 7908221680632



REF.: AR1011-13

CÓD.BARRA: 7908221680564



REF.: AR1011-16

CÓD.BARRA: 7908221680595



REF.: AR1011-20

CÓD.BARRA: 7908221680601



REF.: AR1011-42

CÓD.BARRA: 7908221680649



REF.: AR1011-21

CÓD.BARRA: 7908221680618

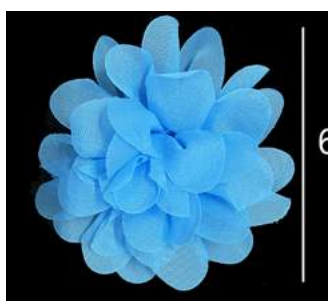

REF.: AR1011-27

CÓD.BARRA: 7908221680663



REF.: AR1011-31

CÓD.BARRA: 7908221680625



REF.: AR1011-44

CÓD.BARRA: 7908221680670

APLICAÇÃO DE FLOR

FLOR PARA - 4,8 cm

PACOTE COM 100 UNIDADES

100% POLIÉSTER

NCM: 5808.90.00 IPI: 0%

R\$ 47,20

PREÇO PACOTE



REF.: AR1013-29

CÓDIGO DE BARRA: 7908221680311



REF.: AR1013-28

CÓD.BARRA: 7908221680328



REF.: AR1013-645

CÓD.BARRA: 7908221680441



REF.: AR1013-1012

CÓD.BARRA: 7908221680472



REF.: AR1013-750

CÓD.BARRA: 7908221680458



REF.: AR1013-1094

CÓD.BARRA: 7908221680519



REF.: AR1013-235

CÓD.BARRA: 7908221680373



REF.: AR1013-175

CÓD.BARRA: 7908221680366



REF.: AR1013-156

CÓD.BARRA: 7908221680359



REF.: AR1013-124

CÓD.BARRA: 7908221680342



REF.: AR1013-1016

CÓD.BARRA: 7908221680489



REF.: AR1013-1058

CÓD.BARRA: 7908221680427



REF.: AR1013-1057

CÓD.BARRA: 7908221680397



REF.: AR1013-370

CÓD.BARRA: 7908221680502

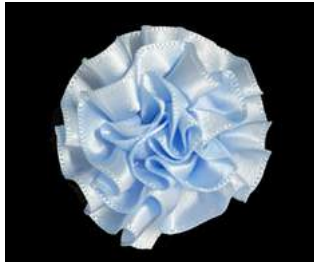

REF.: AR1013-308

CÓD.BARRA: 7908221680380



REF.: AR1013-340

CÓD.BARRA: 7908221680403



REF.: AR1013-1064

CÓD.BARRA: 7908221680496



REF.: AR1013-580

CÓD.BARRA: 7908221680434



REF.: AR1013-570

CÓD.BARRA: 7908221680410



REF.: AR1013-1059

CÓD.BARRA: 7908221680397



REF.: AR1013-30

CÓD.BARRA: 7908221680335

PALAS



REF.: PAL-008

PALA 27X10 CM PACOTE COM 50 UNIDADES

CÓDIGO DE BARRA: 7908221618291

NCM: 5810.10.00 IPI: 0%

FRAÇÃO PACOTE C/50 UNID

R\$ 1,50

PREÇO UNITÁRIO



REF.:REF.: PAL-018

PALA 34X15 CM - PACOTE COM 50 UNIDADES

CÓDIGO DE BARRA: 77908221618321

NCM: 5810.10.00 IPI: 0%

FRAÇÃO PACOTE C/50 UNID

R\$ 3,80

PREÇO UNITÁRIO

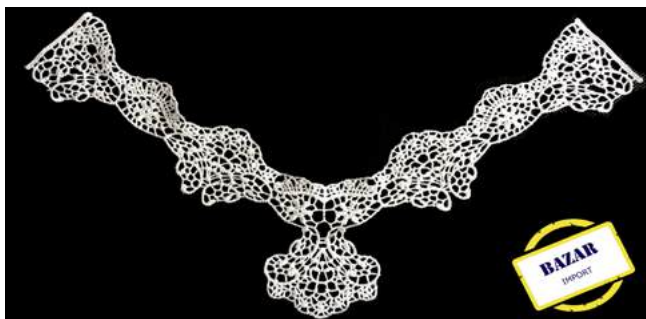

REF.: PAL-009

PALA 25X7,5 CM- PACOTE COM 50 UNIDADES

CÓDIGO DE BARRA: 7908221618284

NCM: 5810.10.00 IPI:0%

FRAÇÃO PACOTE C/50 UNID

R\$ 1,30

PREÇO UNITÁRIO



REF.: AR0033-R4

FITA JUTA RENDADA - 8 CM X 10 M

CÓDIGO DE BARRA: 7908221605789

NCM: 5806.39.00 IPI: 0%

FRAÇÃO 6 UNID. (PACOTE)

R\$ 35,90

PREÇO UNITÁRIO



REF.: AR0033-R5

FITA JUTA RENDADA - 10 CM X 10 M

CÓDIGO DE BARRA: 7908221605796

NCM: 5806.39.00 IPI:0%

FRAÇÃO 6 UNID. (PACOTE)

R\$ 36,50

PREÇO UNITÁRIO

MINI ROCOCÓ

MINI ROCOCÓ - 1,5 cm

PACOTE COM 500 UNIDADES

NCM: 6117.90.00 IPI: 0%

FRAÇÃO PACOTE COM 500 UNIDADES

R\$ 32,80

PREÇO PACOTE



REF.: GA76-1

CÓDIGO DE BARRA:



REF.: GA76-2

CÓDIGO DE BARRA:



REF.: GA76-3

CÓDIGO DE BARRA:



REF.: GA76-4

CÓDIGO DE BARRA:



REF.: GA76-5

CÓDIGO DE BARRA:



REF.: GA76-6

CÓDIGO DE BARRA:



REF.: GA76-7

CÓDIGO DE BARRA:



REF.: GA76-8

CÓDIGO DE BARRA:



REF.: GA76-9

CÓDIGO DE BARRA:



REF.: GA76-10

CÓDIGO DE BARRA:



REF.: GA76-11

CÓDIGO DE BARRA:



REF.: GA76-12

CÓDIGO DE BARRA:



REF.: GA76-13

CÓDIGO DE BARRA:



REF.: GA76-14

CÓDIGO DE BARRA:



REF.: GA76-15

CÓDIGO DE BARRA:



REF.: GA76-16

CÓDIGO DE BARRA:



REF.: GA76-17

CÓDIGO DE BARRA:



REF.: GA76-18

CÓDIGO DE BARRA:



REF.: GA76-19

CÓDIGO DE BARRA:

MINI ROCOCÓ

MINI ROCOCÓ COM FOLHAS - 2,5 cm

PACOTE COM 500 UNIDADES

NCM: 6117.90.00 IPI: 0%

FRAÇÃO PACOTE COM 500 UNIDADES

R\$ 45,90

PREÇO PACOTE



REF.: GA88-1

CÓDIGO DE BARRA: 7908221682957



REF.: GA88-2

CÓDIGO DE BARRA: 7908221682964



REF.: GA88-3

CÓDIGO DE BARRA: 7908221682940



REF.: GA88-4

CÓDIGO DE BARRA: 7908221682971



REF.: GA88-5

CÓDIGO DE BARRA: 7908221682988



REF.: GA88-6

CÓDIGO DE BARRA: 7908221682995



REF.: GA88-7

CÓDIGO DE BARRA: 7908221683008



REF.: GA88-8

CÓDIGO DE BARRA: 7908221683015



REF.: GA88-9

CÓDIGO DE BARRA: 7908221683022



REF.: GA88-10

CÓDIGO DE BARRA: 7908221683039



REF.: GA88-11

CÓDIGO DE BARRA: 7908221683046



REF.: GA88-12

CÓDIGO DE BARRA: 7908221683053



REF.: GA88-13

CÓDIGO DE BARRA: 7908221683060



REF.: GA88-14

CÓDIGO DE BARRA: 7908221683077



REF.: GA88-15

CÓDIGO DE BARRA: 7908221683084



REF.: GA88-16

CÓDIGO DE BARRA: 7908221683091



REF.: GA88-17

CÓDIGO DE BARRA: 7908221683107



REF.: GA88-18

CÓDIGO DE BARRA: 7908221683114



REF.: GA88-19

CÓDIGO DE BARRA: 7908221683121

ENFEITE ROCOCÓ



REF.: GA77-114

ENFEITE ROCOCÓ CARAMELO

CÓDIGO DE BARRA: 7908221618215

NCM: 6117.90.00 IPI: 0%

FRAÇÃO PACOTE C/ 100 UNID

ESGOTADO

PREÇO POR PACOTE



REF.: GA77-32

ENFEITE ROCOCÓ MARROM

CÓDIGO DE BARRA: 7908221618253

NCM: 6117.90.00 IPI: 0%

FRAÇÃO PACOTE C/ 100 UNID

R\$ 4,25

PREÇO POR PACOTE



REF.: GA77-21

ENFEITE ROCOCÓ LILÁS

CÓDIGO DE BARRA: 7908221618246

NCM: 6117.90.00 IPI: 0%

FRAÇÃO PACOTE C/ 100 UNID

R\$ 4,25

PREÇO POR PACOTE



REF.: GA77-110

ENFEITE ROCOCÓ VERDE MUSGO

CÓDIGO DE BARRA: 7908221618208

NCM: 6117.90.00 IPI: 0%

FRAÇÃO PACOTE C/ 100 UNID

R\$ 4,25

PREÇO POR PACOTE

IMÃ BOLA



REF.:AR8X3

IMÃ BOLA 8X3MM - 1X1000

CÓDIGO DE BARRA: 7908221613715

NCM: 8505.19.90 IPI: 9,75%

FRAÇÃO PACOTE

R\$ 24,15

PREÇO PACOTE



REF.: AR12X3

IMÃ BOLA 12X3MM 1X1000

CÓDIGO DE BARRA: 7908221613722

NCM: 8505.19.90 IPI: 9,75%

FRAÇÃO PACOTE

R\$ 41,75

PREÇO PACOTE



REF.:AR15X3

IMÃ BOLA 15X3MM 1X1000

CÓDIGO DE BARRA: 7908221613739

NCM: 8505.19.90 IPI: 9,75%

FRAÇÃO PACOTE

R\$ 43,60

PREÇO PACOTE

MEIA PÉROLA



6 MM



REF.: AR-MP06-BR

MEIA PÉROLA BRANCA 6 MM
EM ABS - PACOTE C/ 500G

CÓDIGO DE BARRA: 7908221613289

NCM: 3926.90.90 IPI: 9,75%

FRAÇÃO PACOTE

R\$ 24,80

PREÇO POR PACOTE



8 MM



REF. AR-MP08-BR

MEIA PÉROLA BRANCA 8 MM
EM ABS 500G - PACOTE C/ 500G

CÓDIGO DE BARRA: 7908221613302

NCM: 3926.90.90 IPI: 9,75%

FRAÇÃO PACOTE

R\$ 24,80

PREÇO POR PACOTE



10 MM



REF.: AR-MP10-BR

MEIA PÉROLA BRANCA 10 MM
EM ABS 500G - PACOTE C/ 500 G

CÓDIGO DE BARRA: 7908221613326

NCM: 3926.90.90 IPI: 9,75%

FRAÇÃO PACOTE

R\$ 24,80

PREÇO POR PACOTE



6 MM



REF.: AR-MP06-CR

MEIA PÉROLA CHAMPAGNE 6 MM
EM ABS - PACOTE C/ 500G

CÓDIGO DE BARRA: 7908221613296

NCM: 3926.90.90 IPI: 9,75%

FRAÇÃO PACOTE

R\$ 24,80

PREÇO POR PACOTE



10 MM



REF.: AR-MP10-CR

MEIA PÉROLA CHAMPAGNE 10 MM
EM ABS 500G - PACOTE C/ 500G

CÓDIGO DE BARRA: 7908221613333

NCM: 3926.90.90 IPI: 9,75%

FRAÇÃO PACOTE

R\$ 24,80

PREÇO POR PACOTE



12 MM



REF.: AR-MP12-CR

MEIA PÉROLA CHAMPAGNE 12 MM
EM ABS - PACOTE C/ 500G

CÓDIGO DE BARRA: 7908221613357

NCM: 3926.90.90 IPI: 9,75%

FRAÇÃO PACOTE

R\$ 24,80

PREÇO POR PACOTE



14 MM



REF.: AR-MP14-CR

MEIA PÉROLA CHAMPAGNE 14 MM
EM ABS - PACOTE C/ 500G

CÓDIGO DE BARRA: 7908221613371

NCM: 3926.90.90 IPI: 9,75%

FRAÇÃO PACOTE

R\$ 24,80

PREÇO POR PACOTE

PÉROLAS

PÉROLAS

PACOTE COM 500 g
100% PLÁSTICO ABS

NCM: 3926.90.90 IPI: 9,75%



CHAMPANHE

BRANCA

REF.: AR-P04-CR

CHAMPANHE - 4 mm

CÓDIGO DE BARRA: 7908221617959

REF.: AR-P04-BR

BRANCA - 4 mm

CÓDIGO DE BARRA: 7908221617942

R\$ 35,50

PREÇO PACOTE

REF.: AR-P05-CR

CHAMPANHE - 5 mm

CÓDIGO DE BARRA: 7908221687556

REF.: AR-P05-BR

BRANCA - 5 mm

CÓDIGO DE BARRA: 7908221687563

R\$ 29,00

PREÇO PACOTE

REF.: AR-P06-CR

CHAMPANHE - 6 mm

CÓDIGO DE BARRA: 7908221619236

REF.: AR-P06-BR

BRANCA - 6 mm

CÓDIGO DE BARRA: 7908221617973

R\$ 21,50

PREÇO PACOTE

REF.: AR-P08-CR

CHAMPANHE - 8 mm

CÓDIGO DE BARRA: 7908221617980

REF.: AR-P08-BR

BRANCA - 8 mm

CÓDIGO DE BARRA: 7908221647543

R\$ 21,50

PREÇO PACOTE

REF.: AR-P10-CR

CHAMPANHE - 10 mm

CÓDIGO DE BARRA: 7908221647550

REF.: AR-P10-BR

BRANCA - 10 mm

CÓDIGO DE BARRA: 7908221617997

R\$ 21,50

PREÇO PACOTE

PÉROLAS

PÉROLAS CRAQUELADA

PACOTE COM 500 g
100% PLÁSTICO ABS
NCM: 3926.90.90 IPI: 9,75%



CHAMPANHE

BRANCA

N°10 - 10 mm

REF.: AR-PP-10CR

CHAMPANHE - 10 mm

CÓDIGO DE BARRA: 7908221687495

R\$ 68,75

PREÇO PACOTE

REF.: AR-PP-10BR

BRANCA - 10 mm

CÓDIGO DE BARRA: 7908221687501

R\$ 68,75

PREÇO PACOTE

N°12 - 12 mm

REF.: AR-PP-12CR

CHAMPANHE - 12 mm

CÓDIGO DE BARRA: 7908221687518

R\$ 49,05

PREÇO PACOTE

REF.: AR-PP-12BR

BRANCA - 12 mm

CÓDIGO DE BARRA: 7908221687525

R\$ 49,05

PREÇO PACOTE

N°14 - 14 mm

REF.: AR-PP-14CR

CHAMPANHE - 14 mm

CÓDIGO DE BARRA: 7908221687532

R\$ 38,55

PREÇO PACOTE

REF.: AR-PP-14BR

BRANCA - 14 mm

CÓDIGO DE BARRA: 7908221687549

R\$ 38,55

PREÇO PACOTE

N°15 - 15 mm

REF.: AR-PP-15CR

CHAMPANHE - 15 mm

CÓDIGO DE BARRA: 7908221618017

R\$ 58,05

PREÇO PACOTE

REF.: AR-PP-15BR

BRANCA - 15 mm

CÓDIGO DE BARRA: 7908221618000

R\$ 58,05

PREÇO PACOTE

PÉROLAS

PÉROLAS METALIZADA

PACOTE COM 500 g

100% PLÁSTICO

NCM: 3926.90.90 IPI: 9,75%



DOURADO

DOURADO ESCURO

PRATA

N°6 - 6 mm

REF.: AR-PC-6G

DOURADO - 6 mm

CÓDIGO DE BARRA: 7908221687433

R\$ 25,45

PREÇO PACOTE

REF.: AR-PC-6DG

DOURADO ESCURO - 6 mm

CÓDIGO DE BARRA: 7908221687440

R\$ 25,45

PREÇO PACOTE

REF.: AR-PC-6S

PRATA - 6 mm

CÓDIGO DE BARRA: 7908221687457

R\$ 25,45

PREÇO PACOTE

N°8 - 8 mm

REF.: AR-PC-8G

DOURADO - 8 mm

CÓDIGO DE BARRA: 7908221687464

R\$ 25,45

PREÇO PACOTE

REF.: AR-PC-8DG

DOURADO ESCURO - 8 mm

CÓDIGO DE BARRA: 7908221687471

R\$ 25,45

PREÇO PACOTE

REF.: AR-PC-8S

PRATA - 8 mm

CÓDIGO DE BARRA: 7908221687488

R\$ 25,45

PREÇO PACOTE



REF.: AR-PM-10BR

PÉROLA EM FIO 10 MM BRANCA

CÓDIGO DE BARRA: 7908221618086

NCM: 3926.90.90 IPI: 9,75%

FRAÇÃO

ROLO

REF.: UT0202-BM

APLICADOR DE PÉROLAS

CÓDIGO DE BARRA: 7908221630538

NCM: 8205.51.00 IPI: 5,2%

FRAÇÃO

UNIDADE

**CONTÉM : 1 CHAVE E
4 PEÇAS PARA
REGULAGEM**

R\$ 117,45

PREÇO UNITÁRIO

ESGOTADO

PREÇO POR ROLO



MIÇANGAS



MIÇANGÃO 6 mm

PACOTE COM 500 gramas

NCM: 7018.10.10 IPI: 13%

R\$ 14,90

PREÇO PACOTE



REF.: M-S1

CÓD.BARRA: 7908221685002

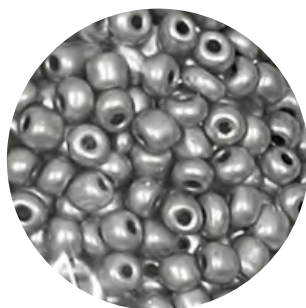

REF.: M-S2

CÓD.BARRA: 7908221685668



REF.: M-G1

CÓD.BARRA: 7908221685019



REF.: M-G2

CÓD.BARRA: 7908221685682



REF.: M-IB

CÓD.BARRA: 7908221684999



REF.: M41B

CÓD.BARRA: 7908221685606

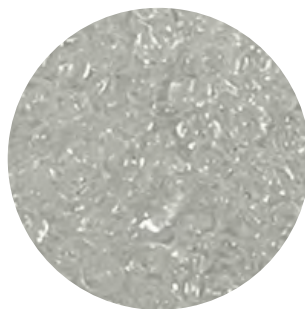

REF.: M21B

CÓD.BARRA: 7908221685163



REF.: M1126

CÓD.BARRA: 7908221685507



REF.: M09

CÓD.BARRA: 7908221685552



REF.: M41

CÓD.BARRA: 7908221685330



REF.: M42

CÓD.BARRA: 7908221685408



REF.: M42B

CÓD.BARRA: 7908221685620

MIÇANGAS



REF.: M04

CÓD.BARRA: 7908221685514



REF.: M50

CÓD.BARRA: 7908221685576



REF.: M46B

CÓD.BARRA: 7908221685583



REF.: M50B

CÓD.BARRA: 7908221685484



REF.: M55

CÓD.BARRA: 7908221685613

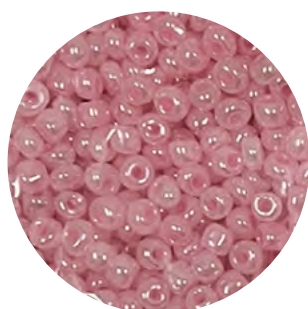

REF.: M145

CÓD.BARRA: 7908221685712



REF.: M04C

CÓD.BARRA: 7908221685644



REF.: M45

CÓD.BARRA: 7908221685491



REF.: M45B

CÓD.BARRA: 7908221685521



REF.: M03D

CÓD.BARRA: 7908221685477



REF.: M03C

CÓD.BARRA: 7908221685675



REF.: M1128

CÓD.BARRA: 7908221685415



REF.: M03

CÓD.BARRA: 7908221685439



REF.: M03B

CÓD.BARRA: 7908221685545



REF.: M04B

CÓD.BARRA: 7908221685590



REF.: M05

CÓD.BARRA: 7908221685460

MIÇANGAS



REF.: M48B

CÓD.BARRA: 7908221685422



REF.: M48C

CÓD.BARRA: 7908221685378

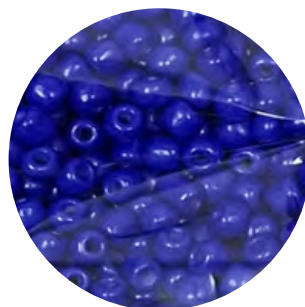

REF.: M48

CÓD.BARRA: 7908221685538



REF.: M43B

CÓD.BARRA: 7908221685385



REF.: M43

CÓD.BARRA: 7908221685446

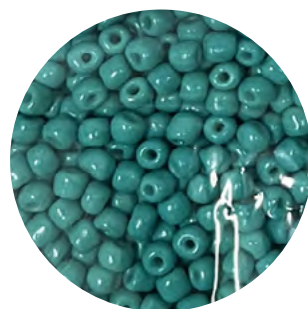

REF.: M43C

CÓD.BARRA: 7908221685637

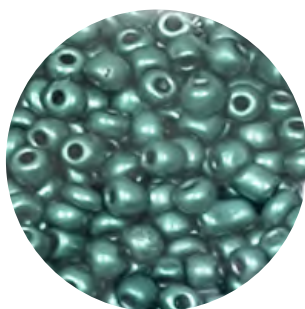

REF.: M1127

CÓD.BARRA: 7908221685651



REF.: M06

CÓD.BARRA: 7908221685453



REF.: M44

CÓD.BARRA: 7908221685354



REF.: M47

CÓD.BARRA: 7908221685392

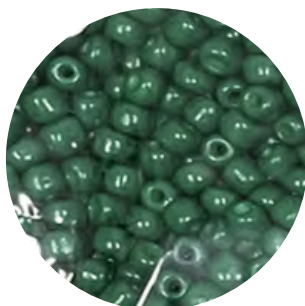

REF.: M47B

CÓD.BARRA: 7908221685569



REF.: M46

CÓD.BARRA: 7908221685361

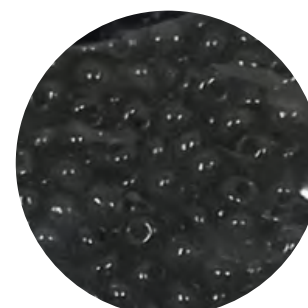

REF.: M49

CÓD.BARRA: 7908221685347

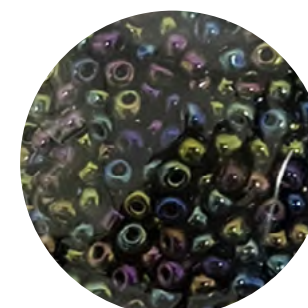

REF.: M409

CÓD.BARRA: 7908221685026

MIÇANGAS

MIÇANGÃO VIDRO 6 mm

PACOTE COM 500 gramas

NCM: 7018.10.10 IPI: 13%

R\$ 19,70

PREÇO PACOTE



REF.: M21

CÓD.BARRA: 7908221685071



REF.: M21C

CÓD.BARRA: 7908221685170



REF.: M22

CÓD.BARRA: 7908221685132



REF.: M30

CÓD.BARRA: 7908221685040

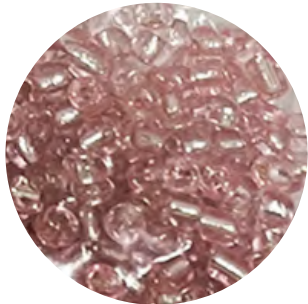

REF.: M08

CÓD.BARRA: 7908221685156

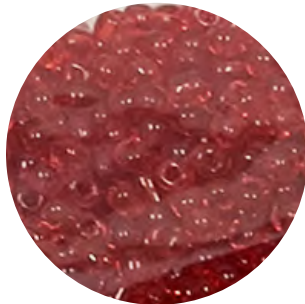

REF.: M25B

CÓD.BARRA: 7908221685200

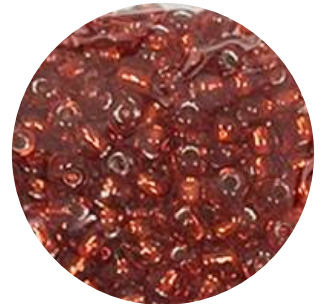

REF.: M25

CÓD.BARRA: 7908221685033

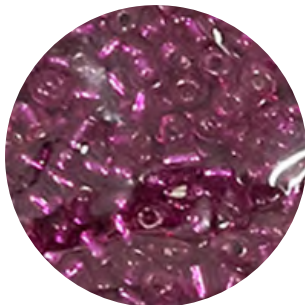

REF.: M07

CÓD.BARRA: 7908221685149



REF.: M28B

CÓD.BARRA: 7908221685101

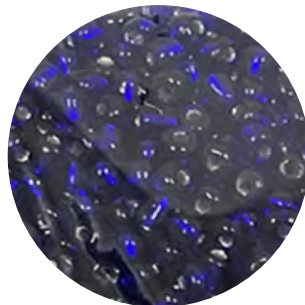

REF.: M28

CÓD.BARRA: 7908221685057

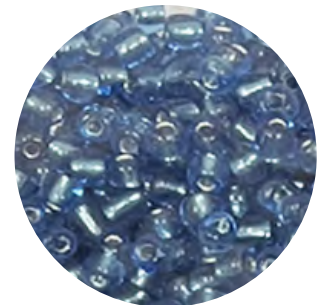

REF.: M23B

CÓD.BARRA: 7908221685125



REF.: M27B

CÓD.BARRA: 7908221685118

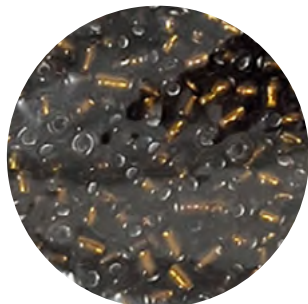

REF.: M31

CÓD.BARRA: 7908221685088



REF.: M001

CÓD.BARRA: 7908221685064



REF.: M32

CÓD.BARRA: 7908221685095

MIÇANGAS



REF.: M1124

CÓD. BARRA: 7908221685187



REF.: M1123

CÓD. BARRA: 7908221685194

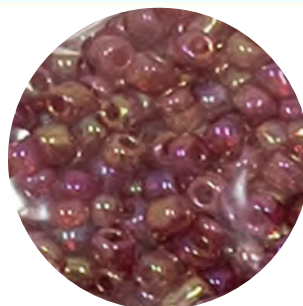

REF.: M1125

CÓD. BARRA: 7908221685217

MIÇANGÃO 6 mm

PACOTE COM 500 gramas
NCM: 7018.10.10 IPI: 13%

R\$ 19,70
PREÇO PACOTE



REF.: V01

CÓD. BARRA: 7908221685279

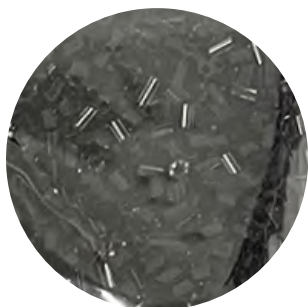

REF.: V11

CÓD. BARRA: 7908221685293



REF.: V-GRA

CÓD. BARRA: 7908221685286

VIDRILHO 1 mm

PACOTE COM 500 gramas
NCM: 7018.10.10 IPI: 13%

R\$ 14,90
PREÇO PACOTE



REF.: V-SI

CÓD. BARRA: 7908221685323



REF.: V31

CÓD. BARRA: 7908221685309



REF.: V35

CÓD. BARRA: 7908221685316

VIDRILHO 1 mm

PACOTE COM 500 gramas
NCM: 7018.10.10 IPI: 13%

R\$ 19,70
PREÇO PACOTE



REF.: C200

CÓD. BARRA: 7908221685262

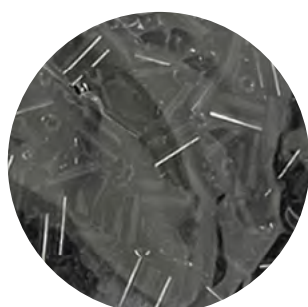

REF.: C02

CÓD. BARRA: 7908221685248



REF.: C252

CÓD. BARRA: 7908221685231

CANUTILHO 6 mm

PACOTE COM 500 gramas
NCM: 7018.10.10 IPI: 13%

R\$ 14,90
PREÇO PACOTE



REF.: C-SI

CÓD. BARRA: 7908221685224



REF.: C31

CÓD. BARRA: 7908221685255

CANUTILHO 6 mm

PACOTE COM 500 gramas
NCM: 7018.10.10 IPI: 13%

R\$ 19,70
PREÇO PACOTE



CONTAS PARA ARTESANATO



REF.: AR-CON-L1

CONTAS P/ ARTESANATO 500G
LETRINHAS - APROX. 4*7MM
CÓDIGO DE BARRA: 7908221643361
NCM: 3926.90.90 IPI: 9,75%

CX MASTER
50 PACOTES

FRAÇÃO
PACOTE

R\$ 37,15
PREÇO PACOTE

R\$ 40,85
PREÇO PACOTE



REF.: AR-CON-L6

CONTAS P/ ARTESANATO 500G
LETRINHAS - APROX. 4*7MM
CÓDIGO DE BARRA: 7908221643415
NCM: 3926.90.90 IPI: 9,75%

CX MASTER
50 PACOTES

FRAÇÃO
PACOTE

R\$ 55,70
PREÇO PACOTE

R\$ 61,25
PREÇO PACOTE



REF.: AR-CON-L2

CONTAS P/ ARTESANATO 500G
LETRINHAS - APROX. 4*7MM
CÓDIGO DE BARRA: 7908221643378
NCM: 3926.90.90 IPI: 9,75%

CX MASTER
50 PACOTES

FRAÇÃO
PACOTE

R\$ 37,15
PREÇO PACOTE

R\$ 40,85
PREÇO PACOTE



REF.: AR-CON-L7

CONTAS P/ ARTESANATO 500G
LETRINHAS - APROX. 4*7MM
CÓDIGO DE BARRA: 7908221643422
NCM: 3926.90.90 IPI: 9,75%

CX MASTER
50 PACOTES

FRAÇÃO
PACOTE

R\$ 55,70
PREÇO PACOTE

R\$ 61,25
PREÇO PACOTE



REF.: AR-CON-L3

CONTAS P/ ARTESANATO 500G
LETRINHAS - APROX. 4*7MM
CÓDIGO DE BARRA: 7908221643385
NCM: 3926.90.90 IPI: 9,75%

CX MASTER
50 PACOTES

FRAÇÃO
PACOTE

R\$ 52,60
PREÇO PACOTE

R\$ 57,85
PREÇO PACOTE



REF.: AR-CON-L8

CONTAS P/ ARTESANATO 500G
LETRINHAS - APROX. 4*7MM
CÓDIGO DE BARRA: 7908221643439
NCM: 3926.90.90 IPI: 9,75%

CX MASTER
50 PACOTES

FRAÇÃO
PACOTE

R\$ 58,80
PREÇO PACOTE

R\$ 64,65
PREÇO PACOTE



REF.: AR-CON-L4

CONTAS P/ ARTESANATO 500G
LETRINHAS - APROX. 4*7MM
CÓDIGO DE BARRA: 7908221643392
NCM: 3926.90.90 IPI: 9,75%

CX MASTER
50 PACOTES

FRAÇÃO
PACOTE

R\$ 40,20
PREÇO PACOTE

R\$ 44,52
PREÇO PACOTE



REF.: AR-CON-L9

CONTAS P/ ARTESANATO 500G
LETRINHAS - APROX. 4*7MM
CÓDIGO DE BARRA: 7908221643446
NCM: 3926.90.90 IPI: 9,75%

CX MASTER
50 PACOTES

FRAÇÃO
PACOTE

R\$ 52,60
PREÇO PACOTE

R\$ 57,85
PREÇO PACOTE



REF.: AR-CON-L5

CONTAS P/ ARTESANATO 500G
LETRINHAS - APROX. 4*7MM
CÓDIGO DE BARRA: 7908221643408
NCM: 3926.90.90 IPI: 9,75%

CX MASTER
50 PACOTES

FRAÇÃO
PACOTE

R\$ 55,70
PREÇO PACOTE

R\$ 61,25
PREÇO PACOTE



REF.: AR-CON-L10

CONTAS P/ ARTESANATO - 500G
LETRINHAS - APROX. 4*7MM
CÓDIGO DE BARRA: 7908221643453
NCM: 3926.90.90 IPI: 9,75%

CX MASTER
50 PACOTES

FRAÇÃO
PACOTE

R\$ 55,70
PREÇO PACOTE

R\$ 61,25
PREÇO PACOTE



CONTAS PARA ARTESANATO



REF.: AR-CON-L11

CONTAS P/ ARTESANATO 500G
LETRINHAS - APROX. 4*7MM
CÓDIGO DE BARRA: 7908221643460
NCM: 3926.90.90 IPI: 9,75%

CX MASTER **FRAÇÃO**
50 PACOTES **PACOTE**

R\$ 55,70 **R\$ 61,25**
PREÇO PACOTE PREÇO PACOTE



REF.: AR-CON-LA2

CONTAS P/ ARTESANATO 500G
LAÇO - APROX. 8*20MM
CÓDIGO DE BARRA: 7908221643644
NCM: 3926.90.90 IPI: 9,75%

CX MASTER **FRAÇÃO**
50 PACOTES **PACOTE**

R\$ 27,85 **R\$ 30,65**
PREÇO PACOTE PREÇO PACOTE



REF.: AR-CON-L12

CONTAS P/ ARTESANATO 500G
LETRINHAS - APROX. 4*7MM
CÓDIGO DE BARRA: 7908221643477
NCM: 3926.90.90 IPI: 9,75%

CX MASTER **FRAÇÃO**
50 PACOTES **PACOTE**

R\$ 55,70 **R\$ 61,25**
PREÇO PACOTE PREÇO PACOTE



REF.: AR-CON-B

CONTAS P/ ARTESANATO 500G
BOLINHAS - APROX. 10MM
CÓDIGO DE BARRA: 7908221643538
NCM: 3926.90.90 IPI: 9,75%

CX MASTER **FRAÇÃO**
50 PACOTES **PACOTE**

R\$ 55,70 **R\$ 61,25**
PREÇO PACOTE PREÇO PACOTE



REF.: AR-CON-L13

CONTAS P/ ARTESANATO 500G
LETRINHAS - APROX. 4*7MM
CÓDIGO DE BARRA: 7908221643484
NCM: 3926.90.90 IPI: 9,75%

CX MASTER **FRAÇÃO**
50 PACOTES **PACOTE**

R\$ 55,70 **R\$ 61,25**
PREÇO PACOTE PREÇO PACOTE



REF.: AR-CON-B2

CONTAS P/ ARTESANATO 500G
BOLINHAS 2 - APROX. 10MM
CÓDIGO DE BARRA: 7908221643545
NCM: 3926.90.90 IPI: 9,75%

CX MASTER **FRAÇÃO**
50 PACOTES **PACOTE**

R\$ 49,50 **R\$ 54,45**
PREÇO PACOTE PREÇO PACOTE



REF.: AR-CON-L14

CONTAS P/ ARTESANATO 500G
LETRINHAS - APROX. 8*8MM
CÓDIGO DE BARRA: 7908221643491
NCM: 3926.90.90 IPI: 9,75%

CX MASTER **FRAÇÃO**
50 PACOTES **PACOTE**

R\$ 40,20 **R\$ 44,25**
PREÇO PACOTE PREÇO PACOTE



REF.: AR-CON-C

CONTAS P/ ARTESANATO 500G
CORACÃO - APROX. 6*6MM
CÓDIGO DE BARRA: 7908221643507
NCM: 3926.90.90 IPI: 9,75%

CX MASTER **FRAÇÃO**
50 PACOTES **PACOTE**

R\$ 40,20 **R\$ 44,25**
PREÇO PACOTE PREÇO PACOTE



REF.: AR-CON-L15

CONTAS P/ ARTESANATO 500G
LETRINHAS - APROX. 4*7MM
CÓDIGO DE BARRA: 7908221643514
NCM: 3926.90.90 IPI: 9,75%

CX MASTER **FRAÇÃO**
50 PACOTES **PACOTE**

R\$ 55,70 **R\$ 61,25**
PREÇO PACOTE PREÇO PACOTE



CONTAS PARA ARTESANATO



REF.:AR-CON-C2

CONTAS P/ ARTESANATO 500G
CORACÃO 2 - APROX. 8*10MM
CÓDIGO DE BARRA: 7908221643552
NCM: 3926.90.90 IPI: 9,75%

CX MASTER
50 PACOTES

FRAÇÃO
PACOTE MSM COR

R\$ 27,85
PREÇO PACOTE

R\$ 30,65
PREÇO PACOTE



REF.: AR-CON-V2

CONTAS P/ ARTESANATO 500G
APROX. 8*12MM
CÓDIGO DE BARRA: 7908221643590
NCM: 3926.90.90 IPI: 9,75%

CX MASTER
50 PACOTES

FRAÇÃO
PACOTE MSM COR

R\$ 27,85
PREÇO PACOTE

R\$ 30,65
PREÇO PACOTE



REF.:AR-CON-LA

CONTAS P/ ARTESANATO 500G
LAÇO- APROX. 4*16MM
CÓDIGO DE BARRA: 7908221643569
NCM: 3926.90.90 IPI: 9,75%

CX MASTER
50 PACOTES

FRAÇÃO
PACOTE MSM COR

R\$ 27,85
PREÇO PACOTE

R\$ 30,65
PREÇO PACOTE



REF.: AR-CON-BA

CONTAS P/ ARTESANATO 500G
BALINHAS - APROX. 10*24MM
CÓDIGO DE BARRA: 7908221643606
NCM: 3926.90.90 IPI: 9,75%

CX MASTER
50 PACOTES

FRAÇÃO
PACOTE MSM COR

R\$ 27,85
PREÇO PACOTE

R\$ 30,65
PREÇO PACOTE



REF.: AR-CON-V10

CONTAS P/ ARTESANATO 500G
BORBOLETA - APROX. 18MM
CÓDIGO DE BARRA: 7908221643613
NCM: 3926.90.90 IPI: 9,75%

CX MASTER
50 PACOTES

FRAÇÃO
PACOTE MSM COR

R\$ 27,85
PREÇO PACOTE

R\$ 30,65
PREÇO PACOTE



REF.: AR-CON-F

CONTAS P/ ARTESANATO 500G
FLOR - APROX. 4*14 MM
CÓDIGO DE BARRA: 7908221643576
NCM: 3926.90.90 IPI: 9,75%

CX MASTER
50 PACOTES

FRAÇÃO
PACOTE MSM COR

R\$ 27,85
PREÇO PACOTE

R\$ 30,65
PREÇO PACOTE



REF.: AR-CON-V9

CONTAS P/ ARTESANATO 500G
APROX. 7*12MM
CÓDIGO DE BARRA: 7908221643637
NCM: 3926.90.90 IPI: 9,75%

CX MASTER
50 PACOTES

FRAÇÃO
PACOTE MSM COR

R\$ 27,85
PREÇO PACOTE

R\$ 30,65
PREÇO PACOTE



REF.: AR-CON-V1

CONTAS P/ ARTESANATO 500G
APROX. 8*15MM
CÓDIGO DE BARRA: 7908221643583
NCM: 3926.90.90 IPI: 9,75%

CX MASTER
50 PACOTES

FRAÇÃO
PACOTE MSM COR

R\$ 27,85
PREÇO PACOTE

R\$ 30,65
PREÇO PACOTE



REF.:AR-CON-V11

CONTAS P/ ARTESANATO 500G
APROX. 5*11MM
CÓDIGO DE BARRA: 7908221643620
NCM: 3926.90.90 IPI: 9,75%

CX MASTER
50 PACOTES

FRAÇÃO
PACOTE MSM COR

R\$ 27,85
PREÇO PACOTE

R\$ 30,65
PREÇO PACOTE



CONTAS PARA ARTESANATO

**REF.: AR-CON-V4**

CONTAS P/ ARTESANATO 500G
APROX. 7*12MM

CÓDIGO DE BARRA: 7908221643668

NCM: 3926.90.90 IPI: 9,75%

CX MASTER
50 PACOTES

FRAÇÃO
PACOTE

R\$ 27,85

PREÇO PACOTE

R\$ 30,65

PREÇO PACOTE

**REF.: AR-CON-V3**

CONTAS P/ ARTESANATO 500G
APROX. 7*12MM

CÓDIGO DE BARRA: 7908221643651

NCM: 3926.90.90 IPI: 9,75%

CX MASTER
50 PACOTES

FRAÇÃO
PACOTE

R\$ 29,40

PREÇO PACOTE

R\$ 32,35

PREÇO PACOTE

**REF.:AR-CON-V5**

CONTAS P/ ARTESANATO 500G
APROX. 7*12MM

CÓDIGO DE BARRA: 7908221643675

NCM: 3926.90.90 IPI: 9,75%

CX MASTER
50 PACOTES

FRAÇÃO
PACOTE

R\$ 27,85

PREÇO PACOTE

R\$ 30,65

PREÇO PACOTE

**REF.: AR-CON-V6**

CONTAS P/ ARTESANATO 500G
APROX. 7*12MM

CÓDIGO DE BARRA: 7908221643682

NCM: 3926.90.90 IPI: 9,75%

CX MASTER
50 PACOTES

FRAÇÃO
PACOTE

R\$ 29,40

PREÇO PACOTE

R\$ 32,35

PREÇO PACOTE

**REF.: AR-CON-V8**

CONTAS P/ ARTESANATO 500G
APROX. 7*12MM

CÓDIGO DE BARRA: 7908221643705

NCM: 3926.90.90 IPI: 9,75%

CX MASTER
50 PACOTES

FRAÇÃO
PACOTE

R\$ 29,40

PREÇO PACOTE

R\$ 32,35

PREÇO PACOTE

**REF.: AR-CON-V7**

CONTAS P/ ARTESANATO 500G
APROX. 7*12MM

CÓDIGO DE BARRA: 7908221643699

NCM: 3926.90.90 IPI: 9,75%

CX MASTER
50 PACOTES

FRAÇÃO
PACOTE

R\$ 27,85

PREÇO PACOTE

R\$ 30,65

PREÇO PACOTE

**REF.: AR-COM-1**

CONTAS BOLA COLORIDAS DE MADEIRA - 14 mm
Aproximamente 1100 contas por Kilo

CÓDIGO DE BARRA: 7908221670220

NCM: 4420.90.00 IPI: 0%

FRAÇÃO 1KG

R\$ 166,80

PREÇO KILO



CONTAS PARA ARTESANATO

CONTA PEROLADA

PACOTE COM 500 g
100% PLÁSTICO ABS

NCM: 3926.90.90 IPI: 9,75%



CHAMPANHE

REF.: AR-CP-1

CHAMPANHE - 14 mm

CÓDIGO DE BARRA: 7908221687228



BRANCA

REF.: AR-CP-2

BRANCA - 14 mm

CÓDIGO DE BARRA: 7908221687235



R\$ 39,90

PREÇO PACOTE



CHAMPANHE

REF.: AR-CP-3

CHAMPANHE - 14 mm

CÓDIGO DE BARRA: 7908221687242



BRANCA

REF.: AR-CP-4

BRANCA - 14 mm

CÓDIGO DE BARRA: 7908221687259



R\$ 39,90

PREÇO PACOTE



CHAMPANHE

REF.: AR-CP-5

CHAMPANHE - 14 mm

CÓDIGO DE BARRA: 7908221687266



BRANCA

REF.: AR-CP-6

BRANCA - 14 mm

CÓDIGO DE BARRA: 7908221687273



R\$ 39,90

PREÇO PACOTE

CONTAS PARA ARTESANATO

CONTA PEROLADA

PACOTE COM 500 g
100% PLÁSTICO ABS

NCM: 3926.90.90 IPI: 9,75%



CHAMPANHE

REF.: AR-CP-7

CHAMPANHE - 14 mm

CÓDIGO DE BARRA: 7908221687280



BRANCA

REF.: AR-CP-8

BRANCA - 14 mm

CÓDIGO DE BARRA: 7908221687297



R\$ 39,90

PREÇO PACOTE



CHAMPANHE

REF.: AR-CP-9

CHAMPANHE - 25 mm

CÓDIGO DE BARRA: 7908221687327



BRANCA

REF.: AR-CP-10

BRANCA - 25 mm

CÓDIGO DE BARRA: 7908221687334



R\$ 39,90

PREÇO PACOTE



CHAMPANHE

REF.: AR-CP-11

CHAMPANHE - 35 mm

CÓDIGO DE BARRA: 7908221687341



BRANCA

REF.: AR-CP-12

BRANCA - 35 mm

CÓDIGO DE BARRA: 7908221687358



R\$ 37,25

PREÇO PACOTE

CONTAS PARA ARTESANATO

CONTA PEROLADA

PACOTE COM 500 g
100% PLÁSTICO ABS

NCM: 3926.90.90 IPI: 9,75%



CHAMPANHE

REF.: AR-CP-13

CHAMPANHE - 37 mm

CÓDIGO DE BARRA: 7908221687365



BRANCA

REF.: AR-CP-14

BRANCA - 37 mm

CÓDIGO DE BARRA: 7908221687372



R\$ 35,90

PREÇO PACOTE



CHAMPANHE

REF.: AR-CP-15

CHAMPANHE - 20 mm

CÓDIGO DE BARRA: 7908221687389



R\$ 37,25

PREÇO PACOTE



CHAMPANHE

REF.: AR-CP-16

CHAMPANHE - 11 mm

CÓDIGO DE BARRA: 7908221687396



BRANCA

REF.: AR-CP-17

BRANCA - 11 mm

CÓDIGO DE BARRA: 7908221687402



R\$ 39,90

PREÇO PACOTE

CONTAS PARA ARTESANATO

CONTA PEROLADA

PACOTE COM 500 g

100% PLÁSTICO ABS

NCM: 3926.90.90 IPI: 9,75%



CHAMPANHE

REF.: AR-CP-18

CHAMPANHE - 27 mm

CÓDIGO DE BARRA: 7908221687419



BRANCA

REF.: AR-CP-19

BRANCA - 27 mm

CÓDIGO DE BARRA: 7908221687426



R\$ 39,90

PREÇO PACOTE

ARGOLA PEROLADA

TAMANHO - 40 mm

PACOTE COM 500 g

100% PLÁSTICO ABS

NCM: 3926.90.90 IPI: 9,75%



CHAMPANHE

REF.: AR-AP-1

CHAMPANHE - 40 mm

CÓDIGO DE BARRA: 7908221687303



BRANCA

REF.: AR-AP-2

BRANCA - 40 mm

CÓDIGO DE BARRA: 7908221687310

R\$ 39,90

PREÇO PACOTE

FIO DE SILICONE



0,7 MM	REF.: AR0023-7 FIO DE SILICONE - 0,7 MM x 100 M - 25 ROLOS CÓDIGO DE BARRA: 7908221651984 NCM: 40070019 IPI: 0%	CX MASTER 500 UND R\$ 5,50 PREÇO UNIDADE	FRAÇÃO 25 ROLOS R\$ 6,10 PREÇO UNIDADE
	0,8 MM	REF.: AR0023-8 FIO DE SILICONE - 0,8 MM x 100 M - 25 ROLOS CÓDIGO DE BARRA: 7908221651991 NCM: 40070019 IPI: 0%	CX MASTER 500 UND R\$ 6,00 PREÇO UNIDADE
1,0 MM	REF.: AR0023-10 FIO DE SILICONE - 1 mm x 100 m CÓDIGO DE BARRA: 7908221684883 NCM: 4007.00.19 IPI: 0%	CX MASTER 500 UNID R\$ 8,10 PREÇO UNIDADE	FRAÇÃO 25 ROLOS R\$ 8,95 PREÇO UNIDADE



REF.: AR0023-8P
FIO DE SILICONE - 0,8 MM x 5 M - KIT C/ 10 ROLOS
CÓDIGO DE BARRA: 7908221651953
NCM: 40070019 IPI: 0%

CX MASTER 100 KITS **FRAÇÃO KIT**

R\$ 6,00
PREÇO KIT

R\$ 6,60
PREÇO KIT



REF.: AR0023-13
FIO DE SILICONE - 1 MM x 3 M - KIT C/ 10 ROLOS
CÓDIGO DE BARRA: 7908221651960
NCM: 40070019 IPI: 0%

CX MASTER 100 KITS **FRAÇÃO KIT**

R\$ 6,00
PREÇO KIT

R\$ 6,60
PREÇO KIT

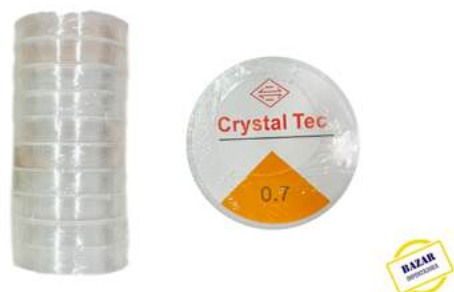

REF.: AR0023-7P
FIO DE SILICONE - 0,7 mm x 10 m
CÓDIGO DE BARRA: 7908221684906
NCM: 4007.00.19 IPI: 0%

CX MASTER 1000 ROLOS **FRAÇÃO 10 ROLOS**

ESGOTADO
PREÇO ROLO

ESGOTADO
PREÇO ROLO

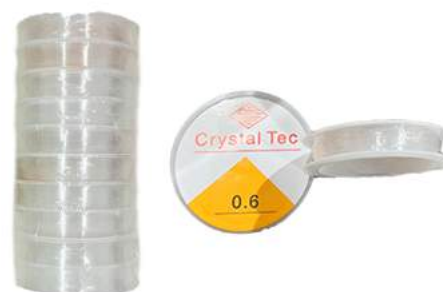

REF.: AR0023-6P
FIO DE SILICONE - 0,6 mm x 10 m
CÓDIGO DE BARRA: 7908221684890
NCM: 4007.00.19 IPI: 0%

CX MASTER 1000 ROLOS **FRAÇÃO 10 ROLOS**

R\$ 0,75
PREÇO ROLO

R\$ 0,85
PREÇO ROLO



FIO DE SILICONE



REF: AR0023-W

FIO DE SILICONE STRETCH BRANCO - 35 m

CÓDIGO DE BARRA: 7908221688133

NCM: 4007.00.19 IPI: 0%

FRAÇÃO 25 ROLOS

R\$ 1,95

PREÇO ROLO

Fio de silicone Stretch
35 m
25 Rolos



REF: AR0023-B

FIO DE SILICONE STRETCH PRETO - 35 m

CÓDIGO DE BARRA: 7908221688140

NCM: 4007.00.19 IPI: 0%

FRAÇÃO 25 ROLOS

R\$ 2,25

PREÇO ROLO



REF: AR0023-500

FIO DE SILICONE STRETCH BRANCO - 500 m

CÓDIGO DE BARRA: 7908221688157

NCM: 4007.00.19 IPI: 0%

FRAÇÃO ROLO

R\$ 27,90

PREÇO ROLO

Fio de Cobre
10 Rolos
0,05 mm x 10 m



REF: AR0230

FIO DE COBRE PARA ARTESANATO - 0,05 mm X 10 m

CÓDIGO DE BARRA: 7908221688201

NCM: 7408.19.00 IPI: 0%

FRAÇÃO KIT COM 10 ROLOS

R\$ 23,65

PREÇO KIT

CAIXA PLÁSTICA

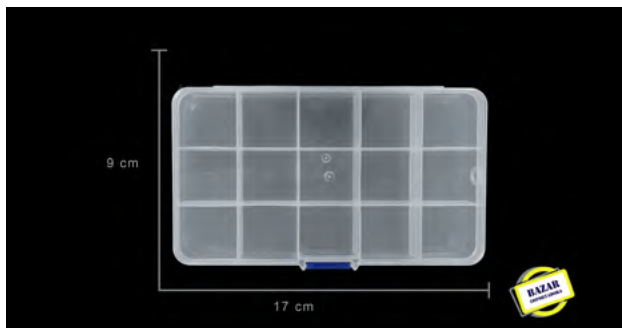

REF.: PL0002

CAIXA PLÁSTICA 15 DIVISÓRIAS - 17 x 9 x 2 CM - 0,050G

CÓDIGO DE BARRA: 7908221651922

NCM: 39249000 IPI: 6,50%

CX MASTER 240 UND FRAÇÃO UNIDADE

R\$ 2,20

PREÇO UNIDADE

R\$ 2,40

PREÇO UNIDADE



REF.: PL0001

CAIXA PLÁSTICA 24 DIVISÓRIAS - 18,5x12,5x2cm

CÓDIGO DE BARRA: 7908221651915

NCM: 39249000 IPI: 6,50%

CX MASTER 160 UND FRAÇÃO UNIDADE

R\$ 2,90

PREÇO UNIDADE

R\$ 3,30

PREÇO UNIDADE



REF.: PL0024

CAIXA ORGANIZADORA - 16 X 9 CM

CÓDIGO DE BARRA: 7908221654947

NCM: 39249000 IPI: 6,50%

CX MASTER 200 UNID FRAÇÃO UNIDADE

R\$ 2,15

PREÇO UNIDADE

R\$ 2,40

PREÇO UNIDADE



REF.: PL0025

CAIXA PLÁSTICA DIVISÓRIAS - 12,5 x 13,5 x 2 CM - 0,05G

CÓDIGO DE BARRA: 7908221654954

NCM: 39249000 IPI: 6,50%

CX MASTER 600 UNID FRAÇÃO UNIDADE

R\$ 2,10

PREÇO UNIDADE

R\$ 2,30

PREÇO UNIDADE

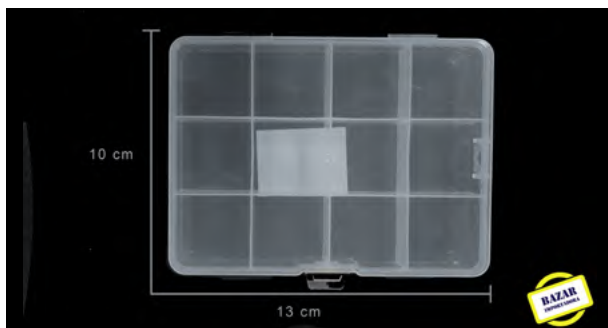

REF.: PL0023

RECIPIENTE PLÁSTICO DIVISÓRIAS - 13 x 10 x 1,5 CM - 0,04G

CÓDIGO DE BARRA: 7908221654930

NCM: 39249000 IPI: 6,50%

CX MASTER 600 UNID FRAÇÃO UNIDADE

R\$ 1,85

PREÇO UNIDADE

R\$ 2,10

PREÇO UNIDADE

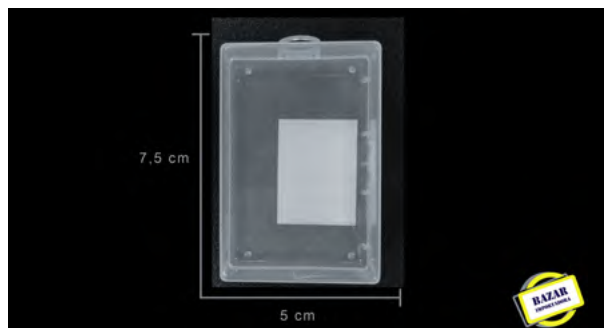

REF.: PL0021

CAIXA PLÁSTICA DIVISÓRIA ÚNICA - 7,5 x 5 x 3 CM - 0,015G

CÓDIGO DE BARRA: 7908221654930

NCM: 39249000 IPI: 6,50%

CX MASTER 600 UNID FRAÇÃO UNIDADE

R\$ 0,80

PREÇO UNIDADE

R\$ 1,00

PREÇO UNIDADE



CAIXA PLÁSTICA

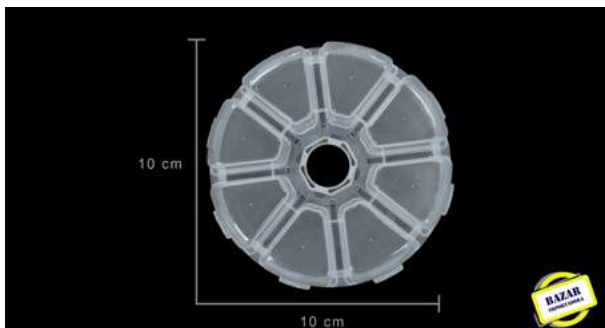

REF: PL0003

CAIXA PLÁSTICA DIVISÓRIAS - 10 x 2 CM - 0,020G
CÓDIGO DE BARRA: 7908221651939
NCM: 39249000 IPI: 6,50%

CX MASTER 200 UND FRAÇÃO UNIDADE

R\$ 1,60

PREÇO UNIDADE

R\$ 1,75

PREÇO UNIDADE

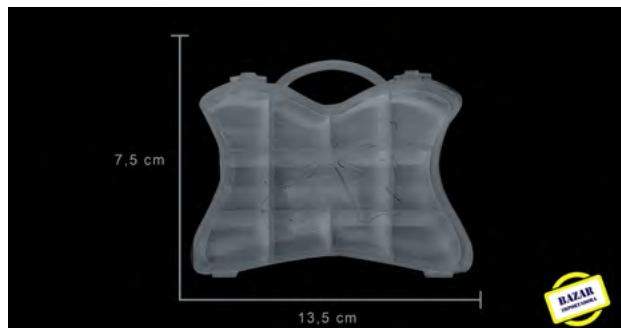

REF: PL0005

RECIPIENTE DE PLÁSTICO - LAÇO - 13,5 x 7,5 x 2 CM - 0,03G
CÓDIGO DE BARRA: 7908221652004
NCM: 39249000 IPI: 6,50%

CX MASTER 288 UNID FRAÇÃO UNIDADE

R\$ 2,35

PREÇO UNIDADE

R\$ 2,60

PREÇO UNIDADE



REF: PL0006

RECIPIENTE DE PLÁSTICO - CORAÇÃO - 17x11,5x2cm
CÓDIGO DE BARRA: 7908221652011
NCM: 39249000 IPI: 6,50%

CX MASTER 288 UND FRAÇÃO UNIDADE

R\$ 2,20

PREÇO UNIDADE

R\$ 2,50

PREÇO UNIDADE

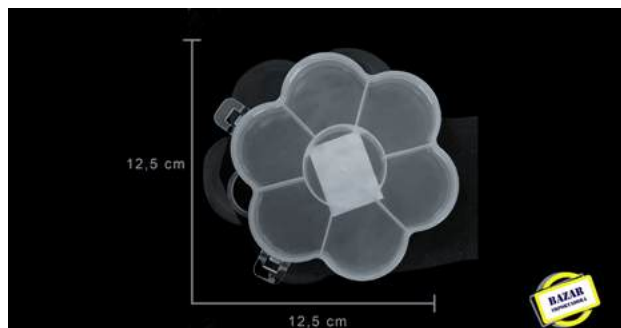

REF: PL0007

RECIPIENTE DE PLÁSTICO - FLOR - 12,5 x 1,5 CM - 0,03G
CÓDIGO DE BARRA: 7908221652028
NCM: 39249000 IPI: 6,50%

CX MASTER 360 UNID FRAÇÃO UNIDADE

R\$ 2,35

PREÇO UNIDADE

R\$ 2,60

PREÇO UNIDADE

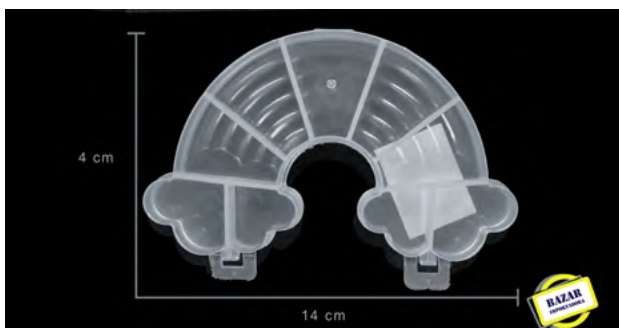

REF: PL0008

RECIPIENTE DE PLÁSTICO - ARCO-ÍRIS - 14 x 4x 1,5 CM - 0,025G
CÓDIGO DE BARRA: 7908221652035
NCM: 39249000 IPI: 6,50%

CX MASTER 300 UND FRAÇÃO UNIDADE

R\$ 2,10

PREÇO UNIDADE

R\$ 2,30

PREÇO UNIDADE



REF: PL0009

RECIPIENTE DE PLÁSTICO CONCHA - 11 X 12 CM
CÓDIGO DE BARRA: 7908221652042
NCM: 39249000 IPI: 6,50%

CX MASTER 300 UNID FRAÇÃO UNIDADE

R\$ 1,95

PREÇO UNIDADE

R\$ 2,15

PREÇO UNIDADE

CAIXA PLÁSTICA

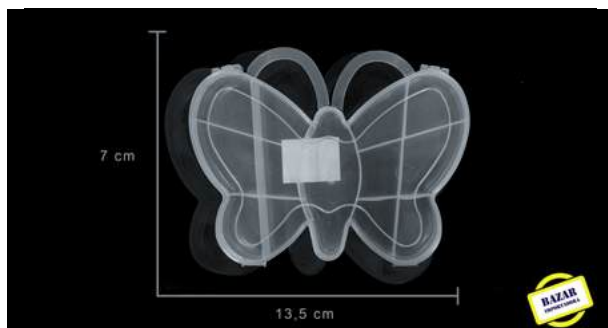

REF: PL0010

RECIPIENTE DE PLÁSTICO - BORBOLETA - 13,5 x 7 x 2 CM - 0,035G

CÓDIGO DE BARRA: 7908221652059

NCM: 39249000 IPI: 6,50%

CX MASTER 288 UNID FRAÇÃO UNIDADE

R\$ 2,35

PREÇO UNIDADE

R\$ 2,60

PREÇO UNIDADE



REF: PL0011

RECIPIENTE DE PLÁSTICO - SAPINHO - 12,5 x 11 x 2 CM - 0,035G

CÓDIGO DE BARRA: 7908221652066

NCM: 39249000 IPI: 6,50%

CX MASTER 216 UNID FRAÇÃO UNIDADE

R\$ 2,35

PREÇO UNIDADE

R\$ 2,60

PREÇO UNIDADE

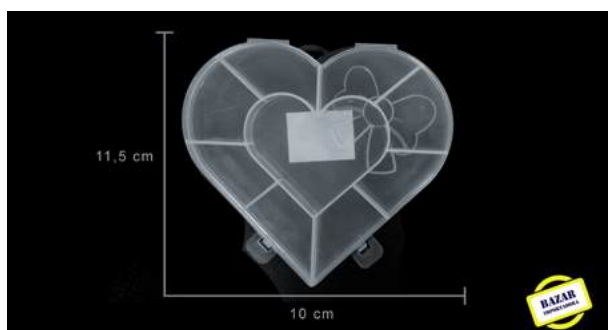

REF: PL0012

RECIPIENTE DE PLÁSTICO - CORAÇÃO - 11,5 x 10 x 1,5 CM - 0,025G

CÓDIGO DE BARRA: 7908221652073

NCM: 39249000 IPI: 6,50%

CX MASTER 360 UNID FRAÇÃO UNIDADE

R\$ 2,35

PREÇO UNIDADE

R\$ 2,60

PREÇO UNIDADE

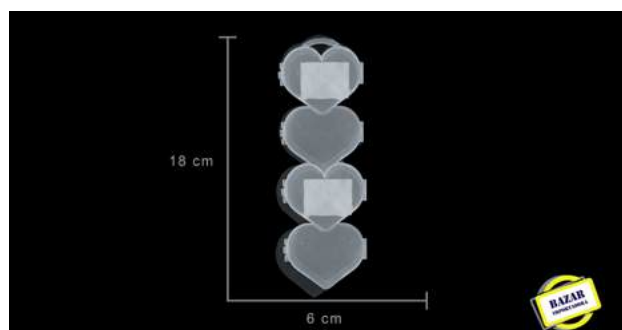

REF: PL0013

RECIPIENTE DE PLÁSTICO - CORAÇÃO - 18 x 6 x 2 CM - 0,035G

CÓDIGO DE BARRA: 7908221652080

NCM: 39249000 IPI: 6,50%

CX MASTER 374 UNID FRAÇÃO UNIDADE

R\$ 1,90

PREÇO UNIDADE

R\$ 2,10

PREÇO UNIDADE

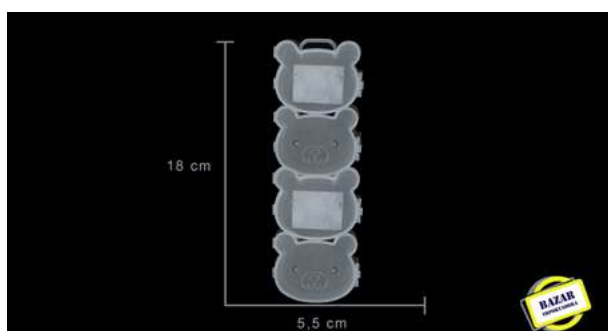

REF: PL0014

RECIPIENTE DE PLÁSTICO - URSO - 18 x 5,5 x 2 CM - 0,030G

CÓDIGO DE BARRA: 7908221652097

NCM: 39249000 IPI: 6,50%

CX MASTER 450 UNID FRAÇÃO UNIDADE

R\$ 2,00

PREÇO UNIDADE

R\$ 2,25

PREÇO UNIDADE



REF: PL0022

CAIXA PLÁSTICA DIVISÓRIA ÚNICA - 6,5 x 5 x 2,5 CM - 0,015G

CÓDIGO DE BARRA: 7908221654923

NCM: 39249000 IPI: 6,50%

CX MASTER 600 UNID FRAÇÃO UNIDADE

R\$ 1,20

PREÇO UNIDADE

R\$ 1,30

PREÇO UNIDADE

CAIXA PLÁSTICA

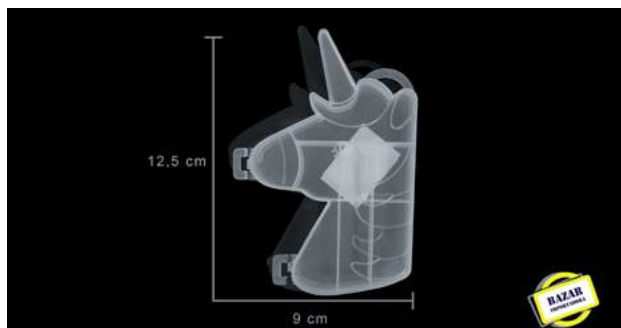

REF.: PL0016

RECIPIENTE DE PLÁSTICO UNICÓRNI0- 12,5 x 9 x 1,70CM - 0,025G

CÓDIGO DE BARRA: 7908221652080

NCM: 39249000 IPI: 6,50%

CX MASTER 300 UNID FRAÇÃO UNIDADE

R\$ 2,10

PREÇO UNIDADE

R\$ 2,30

PREÇO UNIDADE

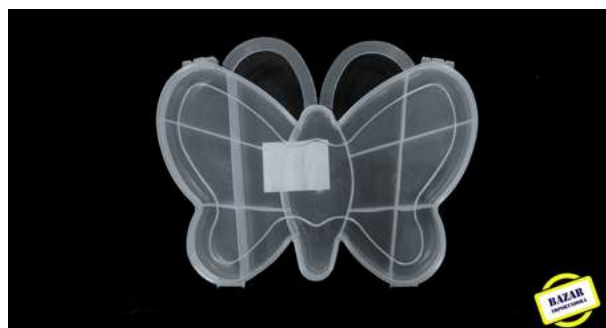

REF.: PL0017

RECIPIENTE DE PLÁSTICO - BORBOLETA 17 x 12 cm

CÓDIGO DE BARRA: 7908221652127

NCM: 39249000 IPI: 6,50%

CX MASTER 240 UNID FRAÇÃO UNIDADE

R\$ 2,30

PREÇO UNIDADE

R\$ 2,55

PREÇO UNIDADE



REF.: PL0018

RECIPIENTE DE PLÁSTICO - CORAÇÃO - 13 X 15 CM

CÓDIGO DE BARRA: 7908221652134

NCM: 39249000 IPI: 6,50%

CX MASTER 240 UNID FRAÇÃO UNIDADE

R\$ 2,30

PREÇO UNIDADE

R\$ 2,55

PREÇO UNIDADE



REF.: PL0019

RECIPIENTE DE PLÁSTICO - URSO - 8,5x5,5x2 CM - 0,015G

CÓDIGO DE BARRA: 7908221652141

NCM: 39249000 IPI: 6,50%

CX MASTER 480 UNID FRAÇÃO UNIDADE

R\$ 1,20

PREÇO UNIDADE

R\$ 1,35

PREÇO UNIDADE

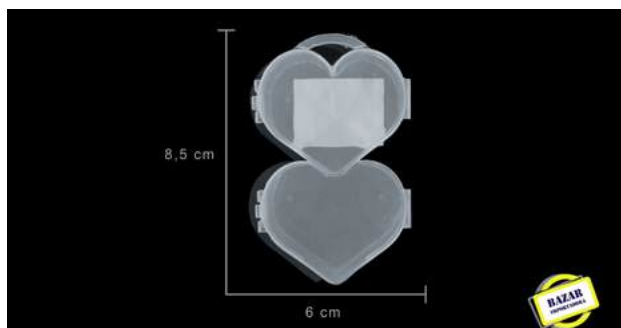

REF.: PL0020

RECIPIENTE DE PLÁSTICO - CORAÇÃO - 8,5 x 6 x 2 CM - 0,015G

CÓDIGO DE BARRA: 7908221652158

NCM: 39249000 IPI: 6,50%

CX MASTER 486 UNID FRAÇÃO UNIDADE

R\$ 1,20

PREÇO UNIDADE

R\$ 1,35

PREÇO UNIDADE



REF.: PL0015

RECIPIENTE DE PLÁSTICO - URSO - 14 X 18 CM

CÓDIGO DE BARRA: 7908221652103

NCM: 39249000 IPI: 6,50%

CX MASTER 240 UNID FRAÇÃO UNIDADE

R\$ 1,95

PREÇO UNIDADE

R\$ 2,15

PREÇO UNIDADE

SAQUINHO PLÁSTICO

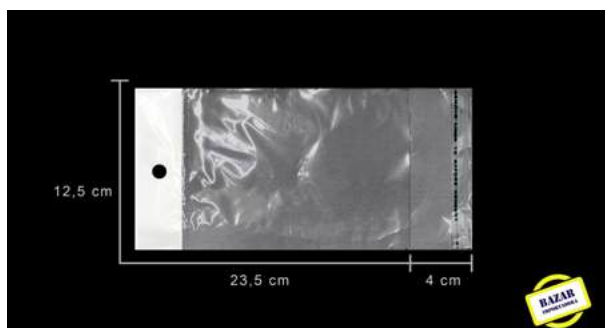

REF.: AR2024-173

SAQUINHO PLÁSTICO TRANSPARENTE - 12.5*23.5 + 4CM

CÓDIGO DE BARRA: 7908221655074

NCM: 39232110 IPI: 9,75%

FRAÇÃO PCT C/ 1000 UND

R\$ 58,00

PREÇO PACOTE

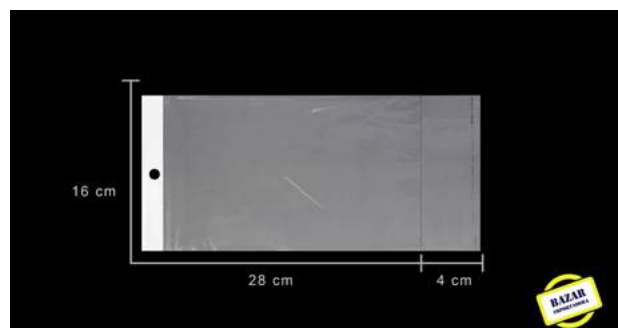

REF.: AR2024-174

SAQUINHO PLÁSTICO TRANSPARENTE - 16*28 + 4CM

CÓDIGO DE BARRA: 7908221655081

NCM: 39232110 IPI: 9,75%

FRAÇÃO PCT C/ 1000 UND

R\$ 72,60

PREÇO PACOTE

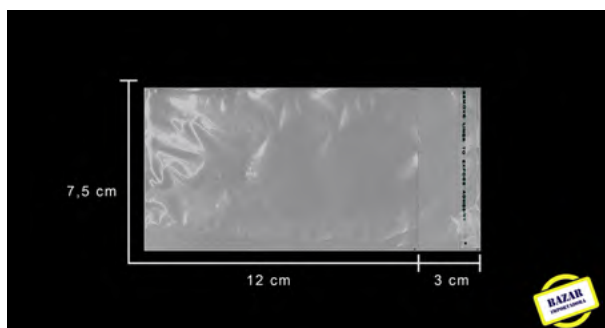

REF.: AR2024-175

SAQUINHO PLÁSTICO TRANSPARENTE - 7.5*12 + 3CM

CÓDIGO DE BARRA: 7908221655098

NCM: 39232110 IPI: 9,75%

FRAÇÃO PCT C/ 1000 UND

R\$ 19,90

PREÇO PACOTE



REF.: AR2024-176

SAQUINHO PLÁSTICO TRANSPARENTE - 12.5*23.5 + 4CM

CÓDIGO DE BARRA: 7908221655104

NCM: 39232110 IPI: 9,75%

FRAÇÃO PCT C/ 1000 UND

R\$ 53,00

PREÇO PACOTE

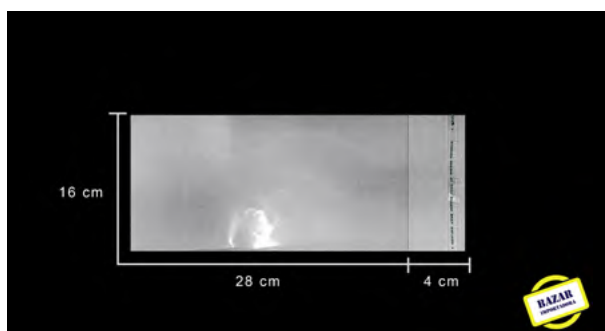

REF.: AR2024-177

SAQUINHO PLÁSTICO TRANSPARENTE - 16*28 + 4CM

CÓDIGO DE BARRA: 7908221655111

NCM: 39232110 IPI: 9,75%

FRAÇÃO PCT C/ 1000 UND

R\$ 69,90

PREÇO PACOTE



REF.: AR2024-178

SAQUINHO PLÁSTICO TRANSPARENTE - 10*15 + 3CM

CÓDIGO DE BARRA: 7908221655128

NCM: 39232110 IPI: 9,75%

FRAÇÃO PCT C/ 1000 UND

R\$ 29,90

PREÇO PACOTE

SAQUINHO PLÁSTICO



REF.: AR2024-179

SAQUINHO PLÁSTICO TRANSPARENTE - 14*20 + 4CM

CÓDIGO DE BARRA: 7908221655135

NCM: 39232110 IPI: 9,75%

FRAÇÃO PCT C/ 1000 UND

R\$ 41,50

PREÇO PACOTE

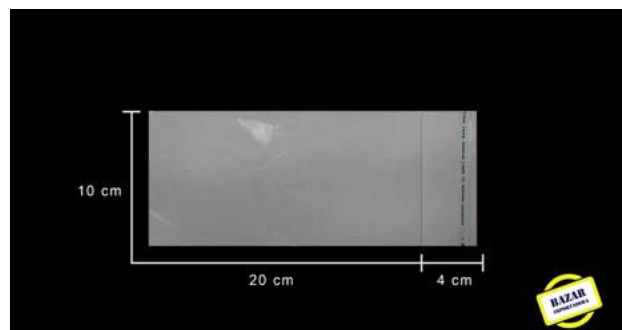

REF.: AR2024-180

SAQUINHO PLÁSTICO TRANSPARENTE - 10*20 + 4CM

CÓDIGO DE BARRA: 7908221655142

NCM: 39232110 IPI: 9,75%

FRAÇÃO PCT C/ 1000 UND

R\$ 31,50

PREÇO PACOTE

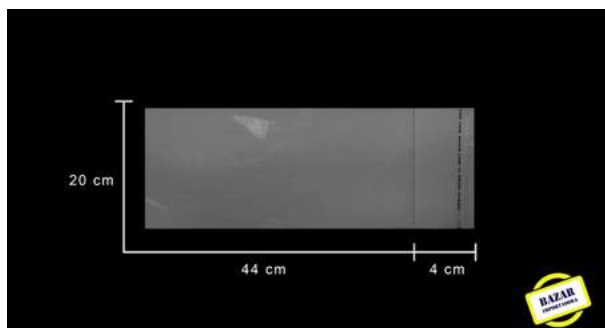

REF.: AR2024-181

SAQUINHO PLÁSTICO TRANSPARENTE - 20*44 + 4CM

CÓDIGO DE BARRA: 7908221655159

NCM: 39232110 IPI: 9,75%

FRAÇÃO PCT C/ 1000 UND

R\$ 106,00

PREÇO PACOTE

MINI POTES DE VIDRO



REF.: UT0009-F

MINI POTE DE VIDRO COM ROLHA
PARA AVIAMENTO - MOD. F

40 mm X 22 mm

CÓDIGO DE BARRA: 7908221625633

NCM: 7010.90.22 IPI: 9,75%

CX MASTER

2100 UND

FRAÇÃO

300 UND

ESGOTADO

PREÇO UNITÁRIO

ESGOTADO

PREÇO UNITÁRIO



REF.: UT0009-H

MINI POTE DE VIDRO COM ROLHA
PARA AVIAMENTO - MOD. H

50 mm X 22 mm

CÓDIGO DE BARRA: 7908221625657

NCM: 7010.90.22 IPI: 9,75%

CX MASTER

2100 UND

FRAÇÃO

300 UND

R\$ 0,55

PREÇO KIT

R\$ 0,65

PREÇO KIT



REF.: UT0009-G

MINI POTE DE VIDRO COM ROLHA
PARA AVIAMENTO - MOD. G

60 mm X 22 mm

CÓDIGO DE BARRA: 7908221625640

NCM: 7010.90.22 IPI: 9,75%

CX MASTER

1200 UND

FRAÇÃO

300 UND

ESGOTADO

PREÇO UNITÁRIO

ESGOTADO

PREÇO UNITÁRIO



REF.: UT0009-K

MINI POTE DE VIDRO COM ROLHA
PARA AVIAMENTO - MOD. K

75 mm X 22 mm

CÓDIGO DE BARRA: 7908221625688

NCM: 7010.90.22 IPI: 9,75%

CX MASTER

1500 UND

FRAÇÃO

300 UND

R\$ 0,70

PREÇO UNITÁRIO

R\$ 0,80

PREÇO UNITÁRIO



REF.: UT0009-I

MINI POTE DE VIDRO COM ROLHA
PARA AVIAMENTO - MOD. I

30 mm X 30 mm

CÓDIGO DE BARRA: 7908221625664

NCM: 7010.90.22 IPI: 9,75%

CX MASTER

800 UND

FRAÇÃO

160 UND

ESGOTADO

PREÇO UNITÁRIO

ESGOTADO

PREÇO UNITÁRIO



REF.: UT0009-J

MINI POTE DE VIDRO COM ROLHA
PARA AVIAMENTO - MOD. J

80 mm X 30 mm

CÓDIGO DE BARRA: 7908221625671

NCM: 7010.90.22 IPI: 9,75%

CX MASTER

800 UND

FRAÇÃO

160 UND

R\$ 1,15

PREÇO UNITÁRIO

R\$ 1,30

PREÇO UNITÁRIO

EVA COM GLITTER



REF.: EVA-E09

PLACA DE EVA 40*60CM
CÓDIGO DE BARRA: 7908221630866
NCM: 3921.19.00 IPI: 9,75%

FRAÇÃO PCT C/ 5 UNID

R\$ 29,00
PREÇO PACOTE



REF.: EVA-E04

PLACA DE EVA 40*60CM
CÓDIGO DE BARRA: 7899724628026
NCM: 5407.51.00 IPI: 9,75%

FRAÇÃO PCT C/ 5 UNID

R\$ 29,00
PREÇO PACOTE



REF.: EVA-E10

PLACA DE EVA 40*60CM
CÓDIGO DE BARRA: 7908221630873
NCM: 3921.19.00 IPI: 9,75%

FRAÇÃO PCT C/ 5 UNID

R\$ 29,00
PREÇO PACOTE

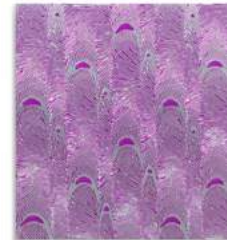

REF.: EVA-E05

PLACA DE EVA 40*60CM
CÓDIGO DE BARRA: 7908221630828
NCM: 3921.19.00 IPI: 9,75%

FRAÇÃO PCT C/ 5 UNID

R\$ 29,00
PREÇO PACOTE



REF.: EVA-E11

PLACA DE EVA 40*60CM
CÓDIGO DE BARRA: 7908221630880
NCM: 3921.19.00 IPI: 9,75%

FRAÇÃO PCT C/ 5 UNID

R\$ 29,00
PREÇO PACOTE



REF.: EVA-E06

PLACA DE EVA 40*60CM
CÓDIGO DE BARRA: 7908221630835
NCM: 3921.19.00 IPI: 9,75%

FRAÇÃO PCT C/ 5 UNID

R\$ 29,00
PREÇO PACOTE



REF.: EVA-E12

PLACA DE EVA 40*60CM
CÓDIGO DE BARRA: 7908221630897
NCM: 3921.19.00 IPI: 9,75%

FRAÇÃO PCT C/ 5 UNID

R\$ 29,00
PREÇO PACOTE

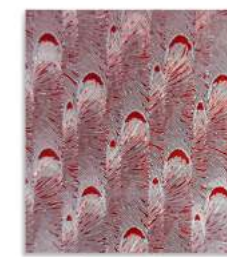

REF.: EVA-E07

PLACA DE EVA 40*60CM
CÓDIGO DE BARRA: 7908221630842
NCM: 3921.19.00 IPI: 9,75%

FRAÇÃO PCT C/ 5 UNID

R\$ 29,00
PREÇO PACOTE



REF.: EVA-E08

PLACA DE EVA 40*60CM
CÓDIGO DE BARRA: 7908221630859
NCM: 3921.19.00 IPI: 9,75%

FRAÇÃO PCT C/ 5 UNID

R\$ 29,00
PREÇO PACOTE



REF.: EVA-E03

PLACA DE EVA 40*60CM
CÓDIGO DE BARRA: 7908221630804
NCM: 3921.19.00 IPI: 9,75%

FRAÇÃO PCT C/ 5 UNID

R\$ 29,00
PREÇO PACOTE

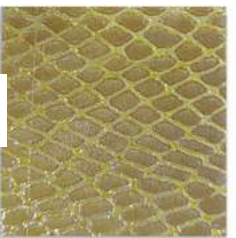

REF.: EVA-E02

PLACA DE EVA 40*60CM
CÓDIGO DE BARRA: 7908221630798
NCM: 3921.19.00 IPI: 9,75%

FRAÇÃO PCT C/ 5 UNID

R\$ 29,00
PREÇO PACOTE

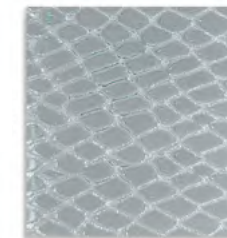

REF.: EVA-E01

PLACA DE EVA 40*60CM
CÓDIGO DE BARRA: 7908221630781
NCM: 3921.19.00 IPI: 9,75%

FRAÇÃO PCT C/ 5 UNID

R\$ 29,00
PREÇO PACOTE



REF.: EVA-01

PLACA DE EVA 40*60CM
CÓDIGO DE BARRA: 7908221630873
NCM: 3921.19.00 IPI: 9,75%

FRAÇÃO PCT C/ 5 UNID

R\$ 17,90

PREÇO PACOTE



REF.: EVA-22

PLACA DE EVA 40*60CM
CÓDIGO DE BARRA: 7908221608605
NCM: 3921.19.00 IPI: 9,75%

FRAÇÃO PCT C/ 5 UNID

R\$ 17,90

PREÇO PACOTE



REF.: EVA-05

PLACA DE EVA 40*60CM
CÓDIGO DE BARRA: 7908221608513
NCM: 3921.19.00 IPI: 9,75%

FRAÇÃO PCT C/ 5 UNID

R\$ 17,90

PREÇO PACOTE

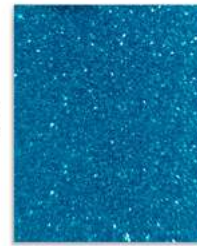

REF.: EVA-09

PLACA DE EVA 40*60CM
CÓDIGO DE BARRA: 7908221608537
NCM: 3921.19.00 IPI: 9,75%

FRAÇÃO PCT C/ 5 UNID

R\$ 17,90

PREÇO PACOTE



REF.: EVA-14

PLACA DE EVA 40*60CM
CÓDIGO DE BARRA: 7908221608551
NCM: 3921.19.00 IPI: 9,75%

FRAÇÃO PCT C/ 5 UNID

R\$ 17,90

PREÇO PACOTE



REF.: EVA-16

PLACA DE EVA 40*60CM
CÓDIGO DE BARRA: 7908221608575
NCM: 3921.19.00 IPI: 9,75%

FRAÇÃO PCT C/ 5 UNID

R\$ 17,90

PREÇO PACOTE



REF.: EVA-17

PLACA DE EVA 40*60CM
CÓDIGO DE BARRA: 7908221608582
NCM: 3921.19.00 IPI: 9,75%

FRAÇÃO PCT C/ 5 UNID

R\$ 17,90

PREÇO PACOTE



REF.: EVA-25

PLACA DE EVA 40*60CM
CÓDIGO DE BARRA: 7908221608629
NCM: 3921.19.00 IPI: 9,75%

FRAÇÃO PCT C/ 5 UNID

R\$ 17,90

PREÇO PACOTE



REF.: EVA-H09

PLACA DE EVA 40*60CM
CÓDIGO DE BARRA: 7908221608681
NCM: 3921.19.00 IPI: 9,75%

FRAÇÃO PCT C/ 5 UNID.

R\$ 19,90

PREÇO PACOTE



REF.: EVA-H01

PLACA DE EVA 40*60CM
CÓDIGO DE BARRA: 7908221608636
NCM: 3921.19.00 IPI: 9,75%

FRAÇÃO PCT C/ 5 UNID.

R\$ 19,90

PREÇO PACOTE



REF.: EVA-H08

PLACA DE EVA 40*60CM
CÓDIGO DE BARRA: 7908221608674
NCM: 3921.19.00 IPI: 9,75%

FRAÇÃO PCT C/ 5 UNID.

R\$ 19,90

PREÇO PACOTE



REF.: EVA-H03

PLACA DE EVA 40*60CM
CÓDIGO DE BARRA: 7908221608650
NCM: 3921.19.00 IPI: 9,75%

FRAÇÃO PCT C/ 5 UNID.

R\$ 19,90

PREÇO PACOTE

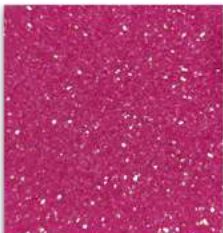

REF.: EVA-H04

PLACA DE EVA 40*60CM
CÓDIGO DE BARRA: 7908221608667
NCM: 3921.19.00 IPI: 9,75%

FRAÇÃO PCT C/ 5 UNID.

R\$ 19,90

PREÇO PACOTE



FITAS ADESIVAS



3,8 cm X m
Espessura - 1 mm



REF.: AR2024-108

FITA DUPLA FACE - 3.8CM*3M - 1MM
CÓDIGO DE BARRA: 7908221655173
NCM: 39191090 IPI: 9,75%

CX MASTER 240 UND **FRAÇÃO UNIDADE**

R\$ 5,20

PREÇO UNIDADE

R\$ 5,75

PREÇO UNIDADE



2,5 cm X m
Espessura - 2 mm



REF.: AR2024-109

FITA DUPLA FACE - 2.5CM*3M - 2MM
CÓDIGO DE BARRA: 7908221655180
NCM: 39191090 IPI: 9,75%

CX MASTER 200 UND **FRAÇÃO UNIDADE**

R\$ 7,60

PREÇO UNIDADE

R\$ 8,40

PREÇO UNIDADE



3,8 cm X 3 m
Espessura - 2 mm



REF.: AR2024-110

FITA DUPLA FACE - 3.8CM*3M - 2MM
CÓDIGO DE BARRA: 7908221655197
NCM: 39191090 IPI: 9,75%

CX MASTER 144 UND **FRAÇÃO UNIDADE**

R\$ 11,25

PREÇO UNIDADE

R\$ 12,40

PREÇO UNIDADE



2,5 cm X 3 m
Espessura - 1 mm



REF.: AR2024-107

FITA DUPLA FACE - 2.5CM*3M - 1MM
CÓDIGO DE BARRA: 7908221655166
NCM: 39191090 IPI: 9,75%

CX MASTER 360 UND **FRAÇÃO UNIDADE**

R\$ 3,45

PREÇO UNIDADE

R\$ 3,80

PREÇO UNIDADE



REF.: AR2024-111

FITA ADESIVA TRANSPARENTE 4.5CM - 200M
CÓDIGO DE BARRA: 7908221655203
NCM: 3919.10.90 IPI: 9,75%

CX MASTER 36 UND **FRAÇÃO UNIDADE**

R\$ 11,75

PREÇO UNITÁRIO

R\$ 12,95

PREÇO UNITÁRIO



FAIXAS



4,7 cm



REF.: AR2024-194

FAIXA REFLETIVA 4,7 mc - 100 metros

CÓDIGO DE BARRA: 7908221655982

NCM: 59070000 IPI: 3,25%

CX MASTER 20 UND

FRAÇÃO 5 UND

R\$ 74,90

PREÇO UNIDADE

R\$ 82,40

PREÇO UNIDADE



5,7 cm



REF.: AR2024-192

FAIXA TECIDO REFLETOR 5,7 cm - 100 metros

CÓDIGO DE BARRA: 7908221655968

NCM: 59070000 IPI: 3,25%

CX MASTER 56 UND

FRAÇÃO 4 UND

R\$ 74,90

PREÇO UNIDADE

R\$ 82,40

PREÇO UNIDADE



4,7 cm



REF.: AR2024-193

FAIXA REFLETIVA 4,7 cm - 100 metros

CÓDIGO DE BARRA: 7908221655975

NCM: 59070000 IPI: 3,25%

CX MASTER 20 UND

FRAÇÃO 5 UND

R\$ 74,90

PREÇO UNIDADE

R\$ 82,40

PREÇO UNIDADE

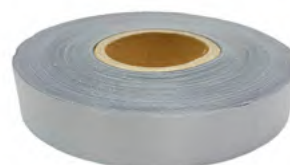

2,3 cm



REF.: AR2024-191

FAIXA TECIDO REFLETOR 2,3 cm - 100 metros

CÓDIGO DE BARRA: 7908221655951

NCM: 59070000 IPI: 3,25%

CX MASTER 56 UND

FRAÇÃO 8 UND

R\$ 37,45

PREÇO UNIDADE

R\$ 41,20

PREÇO UNIDADE

FAIXAS



10 m

REF.: AR189-1

FITA REFLETIVA DE SEGURANÇA
10 M - 5 CM DE LARGURA
CÓDIGO DE BARRA: 7908221655890
NCM: 59070000 IPI: 3,25%

FRAÇÃO UNIDADE

R\$ 12,00

PREÇO UNIDADE



100 m

REF.: AR190-1

FITA REFLETIVA DE SEGURANÇA
100 M - 5 CM DE LARGURA
CÓDIGO DE BARRA: 7908221655920
NCM: 59070000 IPI: 3,25%

FRAÇÃO UNIDADE

R\$ 115,00

PREÇO UNIDADE



10 m

REF.: AR189-2

FITA REFLETIVA DE SEGURANÇA
10 M - 5 CM DE LARGURA
CÓDIGO DE BARRA: 7908221655906
NCM: 59070000 IPI: 3,25%

FRAÇÃO UNIDADE

R\$ 12,00

PREÇO UNIDADE



100 m

REF.: AR190-2

FITA REFLETIVA DE SEGURANÇA
100 M - 5 CM DE LARGURA
CÓDIGO DE BARRA: 7908221655937
NCM: 59070000 IPI: 3,25%

FRAÇÃO UNIDADE

R\$ 115,00

PREÇO UNIDADE



10 m

REF.: AR189-3

FITA REFLETIVA DE SEGURANÇA
10 M - 5 CM DE LARGURA
CÓDIGO DE BARRA: 7908221655913
NCM: 59070000 IPI: 3,25%

FRAÇÃO UNIDADE

R\$ 12,00

PREÇO UNIDADE



100 m

REF.: AR190-3

FITA REFLETIVA DE SEGURANÇA
100 M - 5 CM DE LARGURA
CÓDIGO DE BARRA: 7908221655944
NCM: 59070000 IPI: 3,25%

FRAÇÃO UNIDADE

R\$ 115,00

PREÇO UNIDADE

SAQUINHO DE VOAL



REF.: ARBR10X14

SAQUINHO DE VOAL - 10 x 14 CM

CÓDIGO DE BARRA: 7908221615146

NCM: 6307.90.90 IPI: 0%

FRAÇÃO PACOTE C/ 50 UNID

R\$ 25,30

PREÇO PACOTE



REF.: ARBR20X30

SAQUINHO DE VOAL 20 x 30 CM

CÓDIGO DE BARRA: 7908221614361

NCM: 6307.90.90 IPI: 0%

FRAÇÃO PACOTE C/ 50 UNID

ESGOTADO

PREÇO PACOTE

PORTA RECADO



REF.: LB0050-4

ENFEITE TIPO PORTA RECADO MOD. BICHOS 2 - 1X12

CÓDIGO DE BARRA: 7908221606007

NCM: 9505.90.00 IPI: 13%

FRAÇÃO 12 PACOTES SORTIDOS

R\$ 2,40

PREÇO UNITÁRIO



REF.: LB0050-1

ENFEITE TIPO PORTA RECADO MOD. BICHOS - 1X12

CÓDIGO DE BARRA: 7908221605970

NCM: 9505.90.00 IPI: 13%

FRAÇÃO 12 PACOTES SORTIDOS

R\$ 2,40

PREÇO UNITÁRIO



REF.: LB0050-2

ENFEITE TIPO PORTA RECADO MOD. ANJO 1X12

CÓDIGO DE BARRA: 7908221605987

NCM: 9505.90.00 IPI: 13%

FRAÇÃO 12 PACOTES SORTIDOS

R\$ 2,40

PREÇO UNITÁRIO



REF.: LB0050-3

ENFEITE TIPO PORTA RECADO MOD. CACTO 1X12

CÓDIGO DE BARRA: 7908221605994

NCM: 9505.90.00 IPI: 13%

FRAÇÃO 12 PACOTES SORTIDOS

R\$ 2,40

PREÇO UNITÁRIO

PRENDEDORES

**REF.: LBP-13**

PRENDEDOR 5CM GALINHA 1X6
CÓDIGO DE BARRA: 7908221602276
NCM: 9505.90.00 IPI: 13%

FRAÇÃO 12 PACOTES

R\$ 3,65

PREÇO PACOTE

**REF.: GAP-09**

PRENDEDOR POMBA CORAÇÃO 3,8CM
CÓDIGO DE BARRA: 7908221617751
NCM: 9606.29.00 IPI: 0%

FRAÇÃO 12 PACOTES

R\$ 2,65

PREÇO PACOTE

**REF.: LBP-15**

PRENDEDOR 5CM JOANINHA 1X6
CÓDIGO DE BARRA: 7908221602290
NCM: 9505.90.00 IPI: 13%

FRAÇÃO 12 PACOTES

R\$ 3,65

PREÇO PACOTE

**REF.: GAP-08**

PRENDEDOR LACINHO - 3 CM
CÓDIGO DE BARRA: 7908221617744
NCM: 9506.29.00 IPI: 0%

FRAÇÃO 12 PACOTES

ESGOTADO

PREÇO UNITÁRIO

**REF.: LBP-17**

PRENDEDOR 5CM INSETO - 1X6
CÓDIGO DE BARRA: 7908221602313
NCM: 9505.90.00 IPI: 13%

FRAÇÃO 12 PACOTES

R\$ 3,65

PREÇO PACOTE

**REF.: GAP-01**

PRENDEDOR CORAÇÃO - 3,5 CM
CÓDIGO DE BARRA: 7908221617706
NCM: 9606.29.00 IPI: 13%

FRAÇÃO 12 PACOTES

R\$ 2,65

PREÇO PACOTE

**REF.: LBP-16**

PRENDEDOR 5CM MOD 1X6
CÓDIGO DE BARRA: 7908221602306
NCM: 9505.90.00 IPI: 13%

FRAÇÃO 12 PACOTES

R\$ 3,60

PREÇO PACOTE

**REF.: LBP-14**

PRENDEDOR 5 CM MOD 1X6
CÓDIGO DE BARRA: 7908221602283
NCM: 9505.90.00 IPI: 13%

FRAÇÃO 12 PACOTES

R\$ 3,60

PREÇO PACOTE

FITAS DECORATIVAS



REF: LB0018-P

FITA DESENHOS ROSA - 2 CM x 10 JARDAS

CÓDIGO DE BARRA: 7908221617850

NCM: 5806.32.00 IPI: 0%

FRAÇÃO ROLO

R\$ 6,05

PREÇO ROLO



REF: LB0017-P

FITA URSINHO ROSA - 2 CM x 10 JARDAS

CÓDIGO DE BARRA: 7908221617836

NCM: 5806.32.00 IPI: 0%

FRAÇÃO ROLO

R\$ 6,05

PREÇO ROLO



REF: LB0016-P

FITA MAMADEIRA ROSA - 2 CM x 10 JARDAS

CÓDIGO DE BARRA: 7908221617867

NCM: 5806.32.00 IPI: 0%

FRAÇÃO ROLO

R\$ 6,05

PREÇO ROLO



REF: LB0019-P

FITA BABADOR ROSA - 2 CM x 10 JARDAS

CÓDIGO DE BARRA: 7908221617874

NCM: 5806.32.00 IPI: 0%

FRAÇÃO ROLO

R\$ 6,05

PREÇO ROLO

FITAS DECORATIVAS



REF.: AR1340-00

FITA GORGURÃO ESTAMPADA
APROX. 4CM*10M

CÓDIGO DE BARRA: 7899882868517

NCM: 5407.51.00 IPI: 0%

FRAÇÃO UNIDADE

R\$ 7,95

PREÇO ROLO



REF.: AR1342-00

FITA GORGURÃO ESTAMPADA
APROX. 4CM*10M

CÓDIGO DE BARRA: 7899882868494

NCM: 5407.51.00 IPI: 0%

FRAÇÃO UNIDADE

R\$ 7,95

PREÇO ROLO



REF.: AR1347-00

FITA GORGURÃO ESTAMPADA
APROX. 4CM*10M

CÓDIGO DE BARRA: 7899882868500

NCM: 5407.51.00 IPI: 0%

FRAÇÃO UNIDADE

R\$ 7,95

PREÇO ROLO



REF.: AR1531-11

FITA GORGURÃO ESTAMPADA -
APROX. 4CM*10M

CÓDIGO DE BARRA: 7899882815993

NCM: 5407.51.00 IPI: 0%

FRAÇÃO UNIDADE

R\$ 7,95

PREÇO ROLO



REF.: AR1344-01

FITA GORGURÃO ESTAMPADA
APROX. 4CM*10M

CÓDIGO DE BARRA: 7899882868531

NCM: 5407.51.00 IPI: 0%

FRAÇÃO UNIDADE

R\$ 7,95

PREÇO ROLO



REF.: AR1349-00

FITA GORGURÃO ESTAMPADA -
APROX. 4CM*10M

CÓDIGO DE BARRA: 7899882868524

NCM: 5407.51.00 IPI: 0%

FRAÇÃO UNIDADE

R\$ 7,95

PREÇO ROLO



REF.: AR2470-11

FITA GORGURÃO ESTAMPADA -
APROX. 4CM*10M

CÓDIGO DE BARRA: 7899882868401

NCM: 5407.51.00 IPI: 0%

FRAÇÃO UNIDADE

R\$ 7,95

PREÇO ROLO



REF.: AR1531-15

FITA GORGURÃO ESTAMPADA -
APROX. 4CM*10M

CÓDIGO DE BARRA: 7899882816006

NCM: 5407.51.00 IPI: 0%

FRAÇÃO UNIDADE

R\$ 7,95

PREÇO ROLO



REF.: AR1550-09

FITA GORGURÃO ESTAMPADA -
APROX. 4CM*10M

CÓDIGO DE BARRA: 7899882868456

NCM: 5407.51.00 IPI: 0%

FRAÇÃO UNIDADE

R\$ 7,95

PREÇO ROLO



REF.: AR2090-00

FITA GORGURÃO ESTAMPADA -
APROX. 4CM*10M

CÓDIGO DE BARRA: 7899882868395

NCM: 5407.51.00 IPI: 0%

FRAÇÃO UNIDADE

R\$ 7,95

PREÇO ROLO



REF.: AR2394-17

FITA GORGURÃO ESTAMPADA -
APROX. 4CM*10M

CÓDIGO DE BARRA: 7899882868432

NCM: 5407.51.00 IPI: 0%

FRAÇÃO UNIDADE

R\$ 7,95

PREÇO ROLO

FITAS DECORATIVAS



REF.: AR2492-09

FITA GORGURÃO ESTAMPADA -
APROX. 4CM*10M

CÓDIGO DE BARRA: 7899882816419

NCM: 5407.51.00 IPI: 0%

FRAÇÃO UNIDADE

R\$ 7,95

PREÇO ROLO



REF.: AR2492-10

FITA GORGURÃO ESTAMPADA -
APROX. 4CM*10M

CÓDIGO DE BARRA: 7899882816426

NCM: 5407.51.00 IPI: 0%

FRAÇÃO UNIDADE

R\$ 7,95

PREÇO ROLO



REF.: AR2492-11

FITA GORGURÃO ESTAMPADA -
APROX. 4CM*10M

CÓDIGO DE BARRA: 7899882816433

NCM: 5407.51.00 IPI: 0%

FRAÇÃO UNIDADE

R\$ 7,95

PREÇO ROLO



REF.: AR2492-16

FITA GORGURÃO ESTAMPADA -
APROX. 4CM*10M

CÓDIGO DE BARRA: 7899882816440

NCM: 5407.51.00 IPI: 0%

FRAÇÃO UNIDADE

R\$ 7,95

PREÇO ROLO



REF.: AR2492-17

FITA GORGURÃO ESTAMPADA -
APROX. 4CM*10M

CÓDIGO DE BARRA: 7899882816457

NCM: 5407.51.00 IPI: 0%

FRAÇÃO UNIDADE

R\$ 7,95

PREÇO ROLO



REF.: AR2492-18

FITA GORGURÃO ESTAMPADA -
APROX. 4CM*10M

CÓDIGO DE BARRA: 7899882816464

NCM: 5407.51.00 IPI: 0%

FRAÇÃO UNIDADE

R\$ 7,95

PREÇO ROLO



REF.: AR2492-23

FITA GORGURÃO ESTAMPADA -
APROX. 4CM*10M

CÓDIGO DE BARRA: 7899882816471

NCM: 5407.51.00 IPI: 0%

FRAÇÃO UNIDADE

R\$ 7,95

PREÇO ROLO



REF.: AR2664-00

FITA GORGURÃO ESTAMPADA -
APROX. 4CM*10M

CÓDIGO DE BARRA: 7899882816631

NCM: 5407.51.00 IPI: 0%

FRAÇÃO UNIDADE

R\$ 7,95

PREÇO ROLO



REF.: AR3040-09

FITA GORGURÃO ESTAMPADA -
APROX. 4CM*10M

CÓDIGO DE BARRA: 7899882816839

NCM: 5407.51.00 IPI: 0%

FRAÇÃO UNIDADE

R\$ 7,95

PREÇO ROLO



REF.: AR3131-21

FITA GORGURÃO ESTAMPADA -
APROX. 4CM*10M

CÓDIGO DE BARRA: 7899882816952

NCM: 5407.51.00 IPI: 0%

FRAÇÃO UNIDADE

R\$ 7,95

PREÇO ROLO

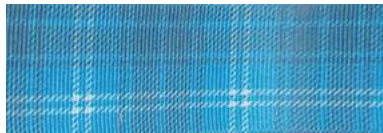

REF.: AR3345-03

FITA GORGURÃO ESTAMPADA -
APROX. 4CM*10M

CÓDIGO DE BARRA: 7899882817157

NCM: 5407.51.00 IPI: 0%

FRAÇÃO UNIDADE

R\$ 7,95

PREÇO ROLO



REF.: AR3345-09

FITA GORGURÃO ESTAMPADA -
APROX. 4CM*10M

CÓDIGO DE BARRA: 7899882817164

NCM: 5407.51.00 IPI: 0%

FRAÇÃO UNIDADE

R\$ 7,95

PREÇO ROLO

FITAS DECORATIVAS



REF.: AR3345-10

FITA GORGURÃO ESTAMPADA -
APROX. 4CM*10M

CÓDIGO DE BARRA: 7899882817171

NCM: 5407.51.00 IPI: 0%

FRAÇÃO UNIDADE

R\$ 7,95

PREÇO ROLO

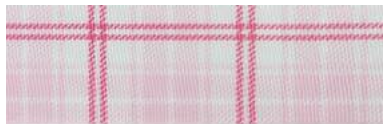

REF.: AR3345-11

FITA GORGURÃO ESTAMPADA -
APROX. 4CM*10M

CÓDIGO DE BARRA: 7899882817188

NCM: 5407.51.00 IPI: 0%

FRAÇÃO UNIDADE

R\$ 7,95

PREÇO ROLO



REF.: AR3345-15

FITA GORGURÃO ESTAMPADA -
APROX. 4CM*10M

CÓDIGO DE BARRA: 7899882817195

NCM: 5407.51.00 IPI: 0%

FRAÇÃO UNIDADE

R\$ 7,95

PREÇO ROLO



REF.: AR3345-23

FITA GORGURÃO ESTAMPADA -
APROX. 4CM*10M

CÓDIGO DE BARRA: 7899882817201

NCM: 5407.51.00 IPI: 0%

FRAÇÃO UNIDADE

R\$ 7,95

PREÇO ROLO



REF.: AR3345-30

FITA GORGURÃO ESTAMPADA -
APROX. 4CM*10M

CÓDIGO DE BARRA: 7899882817218

NCM: 5407.51.00 IPI: 0%

FRAÇÃO UNIDADE

R\$ 7,95

PREÇO ROLO



REF.: AR3345-32

FITA GORGURÃO ESTAMPADA -
APROX. 4CM*10M

CÓDIGO DE BARRA: 7899882817225

NCM: 5407.51.00 IPI: 0%

FRAÇÃO UNIDADE

R\$ 7,95

PREÇO ROLO



REF.: AR3346-11

FITA GORGURÃO ESTAMPADA -
APROX. 4CM*10M

CÓDIGO DE BARRA: 7899882817232

NCM: 5407.51.00 IPI: 0%

FRAÇÃO UNIDADE

R\$ 7,95

PREÇO ROLO



REF.: AR3433-00

FITA GORGURÃO ESTAMPADA -
APROX. 4CM*10M

CÓDIGO DE BARRA: 7899882817324

NCM: 5407.51.00 IPI: 0%

FRAÇÃO UNIDADE

R\$ 7,95

PREÇO ROLO



REF.: AR3450-32

FITA GORGURÃO ESTAMPADA -
APROX. 4CM*10MM

CÓDIGO DE BARRA: 7899882817362

NCM: 5407.51.00 IPI: 0%

FRAÇÃO UNIDADE

R\$ 7,95

PREÇO ROLO



REF.: AR3519-00

FITA GORGURÃO ESTAMPADA -
APROX. 4CM*10M

CÓDIGO DE BARRA: 7899882817508

NCM: 5407.51.00 IPI: 0%

FRAÇÃO UNIDADE

R\$ 7,95

PREÇO ROLO



REF.: AR3531-09

FITA GORGURÃO ESTAMPADA -
APROX. 4CM*10M

CÓDIGO DE BARRA: 7899882868425

NCM: 5407.51.00 IPI: 0%

FRAÇÃO UNIDADE

R\$ 7,95

PREÇO ROLO



REF.: AR3729-07

FITA GORGURÃO ESTAMPADA -
APROX. 4CM*10M

CÓDIGO DE BARRA: 7899882817744

NCM: 5407.51.00 IPI: 0%

FRAÇÃO UNIDADE

R\$ 7,95

PREÇO ROLO

FITAS DECORATIVAS



REF.: AR3731-11

FITA GORGURÃO ESTAMPADA -
APROX. 4CM*10M

CÓDIGO DE BARRA: 7899882817768

NCM: 5407.51.00 IPI: 0%

FRAÇÃO **UNIDADE**

R\$ 7,95

PREÇO ROLO



REF.: AR3959-15

FITA GORGURÃO ESTAMPADA -
APROX. 4CM*10M

CÓDIGO DE BARRA: 7899882818123

NCM: 5407.51.00 IPI: 0%

FRAÇÃO **UNIDADE**

R\$ 7,95

PREÇO ROLO



REF.: AR4004-11

FITA GORGURÃO ESTAMPADA -
APROX. 4CM*10M

CÓDIGO DE BARRA: 7899882818154

NCM: 5407.51.00 IPI: 0%

FRAÇÃO **UNIDADE**

R\$ 7,95

PREÇO ROLO



REF.: AR4021-00

FITA GORGURÃO ESTAMPADA -
APROX. 4CM*10M

CÓDIGO DE BARRA: 7899882818246

NCM: 5407.51.00 IPI: 0%

FRAÇÃO **UNIDADE**

R\$ 7,95

PREÇO ROLO



REF.: AR4023-12

FITA GORGURÃO ESTAMPADA -
APROX. 4CM*10M

CÓDIGO DE BARRA: 7899882818260

NCM: 5407.51.00 IPI: 0%

FRAÇÃO **UNIDADE**

R\$ 7,95

PREÇO ROLO



REF.: AR4135-20

FITA GORGURÃO ESTAMPADA -
APROX. 4CM*10M

CÓDIGO DE BARRA: 7899882868548

NCM: 5407.51.00 IPI: 0%

FRAÇÃO **UNIDADE**

R\$ 7,95

PREÇO ROLO



REF.: AR4169-16

FITA GORGURÃO ESTAMPADA -
APROX. 4CM*10M

CÓDIGO DE BARRA: 7899882818741

NCM: 5407.51.00 IPI: 0%

FRAÇÃO **UNIDADE**

R\$ 7,95

PREÇO ROLO



REF.: AR4170-10

FITA GORGURÃO ESTAMPADA -
APROX. 4CM*10M

CÓDIGO DE BARRA: 7899882818758

NCM: 5407.51.00 IPI: 0%

FRAÇÃO **UNIDADE**

R\$ 7,95

PREÇO ROLO

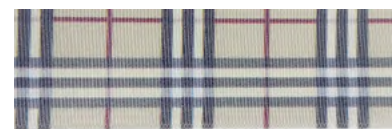

REF.: AR4189-32

FITA GORGURÃO ESTAMPADA -
APROX. 4CM*10M

CÓDIGO DE BARRA: 7899882818871

NCM: 5407.51.00 IPI: 0%

FRAÇÃO **UNIDADE**

ESGOTADO

PREÇO ROLO



REF.: AR4188-00

FITA GORGURÃO ESTAMPADA -
APROX. 4CM*10M

CÓDIGO DE BARRA: 7899882818864

NCM: 5407.51.00 IPI: 0%

FRAÇÃO **UNIDADE**

R\$ 7,95

PREÇO ROLO

FITAS DECORATIVAS



REF.: AR4533-32

FITA GORGURÃO ESTAMPADA -
APROX. 4CM*10M

CÓDIGO DE BARRA: 77899882868470

NCM: 5407.51.00 IPI: 0%

FRAÇÃO **UNIDADE**

R\$ 7,95

PREÇO ROLO



REF.: AR4534-04

FITA GORGURÃO ESTAMPADA -
APROX. 4CM*10M

CÓDIGO DE BARRA: 7899882868487

NCM: 5407.51.00 IPI: 0%

FRAÇÃO **UNIDADE**

R\$ 7,95

PREÇO ROLO



REF.: AR4543-11

FITA GORGURÃO ESTAMPADA -
APROX. 4CM*10M

CÓDIGO DE BARRA: 7899882868418

NCM: 5407.51.00 IPI: 0%

FRAÇÃO **UNIDADE**

R\$ 7,95

PREÇO ROLO



REF.: AR4544-16

FITA GORGURÃO ESTAMPADA -
APROX. 4CM*10M

CÓDIGO DE BARRA: 7899882868449

NCM: 5407.51.00 IPI: 0%

FRAÇÃO **UNIDADE**

R\$ 7,95

PREÇO ROLO



REF.: LB0043-J

FITA GORGURÃO JOANINHAS
APROX. 2,5CM*9,8M

CÓDIGO DE BARRA: 7908221609220

NCM: 5806.32.00 IPI: 0%

FRAÇÃO **UNIDADE**

R\$ 7,50

PREÇO ROLO



REF.: LB0041-1

FITA GORGURÃO UNICÓRNIOS 1
APROX. 2,5CM*9,8M

CÓDIGO DE BARRA: 7908221608858

NCM: 5806.32.00 IPI: 0%

FRAÇÃO **UNIDADE**

R\$ 7,50

PREÇO ROLO



REF.: LB0041-2

FITA GORGURÃO UNICÓRNIOS 2
APROX. 2CM*10M

CÓDIGO DE BARRA: 7908221608865

NCM: 5806.32.00 IPI: 0%

FRAÇÃO **UNIDADE**

R\$ 7,50

PREÇO ROLO



REF.: LB0041-3

FITA GORGURÃO UNICÓRNIOS 3
APROX. 2,5CM*9,8M

CÓDIGO DE BARRA: 7908221608872

NCM: 5806.32.00 IPI: 0%

FRAÇÃO **UNIDADE**

R\$ 7,50

PREÇO ROLO



REF.: LB0041-4

FITA GORGURÃO UNICÓRNIOS 4
APROX. 2,5CM*9,8M

CÓDIGO DE BARRA: 7908221608889

NCM: 5806.32.00 IPI: 0%

FRAÇÃO **UNIDADE**

R\$ 7,50

PREÇO ROLO



REF.: LB0041-5

FITA GORGURÃO UNICÓRNIS 5
APROX. 2,5CM*9,8M

CÓDIGO DE BARRA: 7908221608896

NCM: 5806.32.00 IPI: 0%

FRAÇÃO **UNIDADE**

R\$ 7,50

PREÇO ROLO



REF.: LB0041-6

FITA GORGURÃO UNICÓRNIOS 6
APROX. 2,5CM*9,8M

CÓDIGO DE BARRA: 7908221608902

NCM: 5806.32.00 IPI: 0%

FRAÇÃO **UNIDADE**

R\$ 7,50

PREÇO ROLO

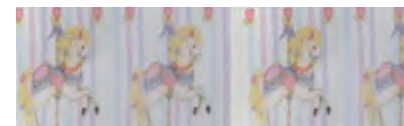

REF.: LB0041-7

FITA GORGURÃO UNICÓRNIOS 7
APROX. 2,5CM*9,8M

CÓDIGO DE BARRA: 7908221608919

NCM: 5806.32.00 IPI: 0%

FRAÇÃO **UNIDADE**

R\$ 7,50

PREÇO ROLO

FITAS DECORATIVAS



REF.:LB0041-8

FITA GORGURÃO UNICÓRNIOS 8
APROX. 2,5CM*9,8M

CÓDIGO DE BARRA: 7908221608926

NCM: 5806.32.00 IPI: 0%

FRAÇÃO UNIDADE

R\$ 7,50

PREÇO ROLO



REF.: LB0041-9

FITA GORGURÃO UNICÓRNIOS 9
APROX. 2,5CM*9,8M

CÓDIGO DE BARRA: 7908221608933

NCM: 5806.32.00 IPI: 0%

FRAÇÃO UNIDADE

R\$ 7,50

PREÇO ROLO



REF.: LB0042-2

FITA GORGURÃO FLAMINGOS 2
APROX. 2,5CM*9,8M

CÓDIGO DE BARRA: 7908221608957

NCM: 5806.32.00 IPI: 0%

FRAÇÃO UNIDADE

R\$ 7,50

PREÇO ROLO



REF.: LB0042-3

FITA GORGURÃO FLAMINGOS 3
APROX. 2,5CM*9,8M

CÓDIGO DE BARRA: 7908221609169

NCM: 5806.32.00 IPI: 0%

FRAÇÃO UNIDADE

R\$ 7,50

PREÇO ROLO



REF.: LB0042-4

FITA GORGURÃO FLAMINGOS 4
APROX. 2,5CM*9,8M

CÓDIGO DE BARRA: 7908221609176

NCM: 5806.32.00 IPI: 0%

FRAÇÃO UNIDADE

R\$ 7,50

PREÇO ROLO



REF.: LB0042-5

FITA GORGURÃO FLAMINGOS 5
APROX. 2,5CM*9,8M

CÓDIGO DE BARRA: 908221609183

NCM: 5806.32.00 IPI: 0%

FRAÇÃO UNIDADE

R\$ 7,50

PREÇO ROLO



REF.:LB0043-U1

FITA GORGURÃO URSINHOS 1
APROX. 2,5CM*9,8M

CÓDIGO DE BARRA: 7908221609190

NCM: 5806.32.00 IPI: 0%

FRAÇÃO UNIDADE

R\$ 7,50

PREÇO ROLO

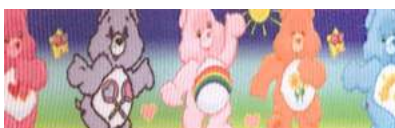

REF.: LB0043-U3

FITA GORGURÃO URSINHOS 2
APROX. 2,5CM*9,8M

CÓDIGO DE BARRA: 7908221609237

NCM: 5806.32.00 IPI: 0%

FRAÇÃO UNIDADE

R\$ 7,50

PREÇO ROLO



REF.: LB0043-C

FITA GORGURÃO CORUJAS
APROX. 2,5CM*9,8M

CÓDIGO DE BARRA: 7908221609213

NCM: 5806.32.00 IPI: 0%

FRAÇÃO UNIDADE

R\$ 7,50

PREÇO ROLO



REF.: LB0043-P1

FITA GORGURÃO SOFT PINK
APROX. 2,5CM*9,8M

CÓDIGO DE BARRA: 7908221609244

NCM: 5806.32.00 IPI: 0%

FRAÇÃO UNIDADE

R\$ 7,50

PREÇO ROLO



REF.: LB0040-ES5

FITA GORGURÃO PÁScoa 5
APROX. 2,5CM*9,8M

CÓDIGO DE BARRA: 7908221607653

NCM: 5806.32.00 IPI: 0%

FRAÇÃO UNIDADE

R\$ 7,50

PREÇO ROLO

FITAS DECORATIVAS

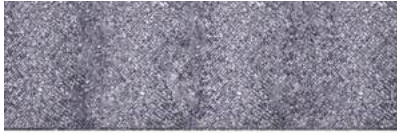

REF.: AR1040-07

FITA CETIM BRILHANTE
APROX. 4CM*10M

CÓDIGO DE BARRA: 7899724641575
NCM: 5407.51.00 IPI: 0% (NACIONAL)

FRAÇÃO **UNIDADE**

R\$ 7,50

PREÇO ROLO



REF.: AR1040-09

FITA CETIM BRILHANTE
APROX. 4CM*10M

CÓDIGO DE BARRA: 7899724605454
NCM: 5407.51.00 IPI: 0% (NACIONAL)

FRAÇÃO **UNIDADE**

R\$ 7,50

PREÇO ROLO

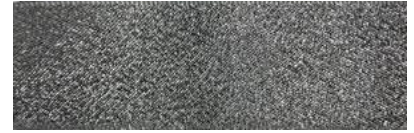

REF.: AR1040-19

FITA CETIM BRILHANTE
APROX. 4CM*10M

CÓDIGO DE BARRA: 7899724651116
NCM: 5407.51.00 IPI: 0% (NACIONAL)

FRAÇÃO **UNIDADE**

R\$ 7,50

PREÇO ROLO



REF.: AR0247-09

FITA CETIM ESTAMPADA
APROX. 4CM*10M

CÓDIGO DE BARRA: 7899724628002
NCM: 5407.51.00 IPI: 0% (NACIONAL)

FRAÇÃO **UNIDADE**

R\$ 10,90

PREÇO POR ROLO



REF.: AR3450-32G

FITA CETIM ESTAMPADA
APROX. 4CM*10M

CÓDIGO DE BARRA: 7899724627999
NCM: 5407.51.00 IPI: 0% (NACIONAL)

FRAÇÃO **UNIDADE**

R\$ 10,90

PREÇO POR ROLO



REF.: LB0041-P1

FITA GORGURÃO BOLINHAS 1
APROX. 2,5CM*9,8M

CÓDIGO DE BARRA: 7898221607646
NCM: 5806.32.00 IPI: 0%

FRAÇÃO **UNIDADE**

R\$ 7,50

PREÇO ROLO



REF.: AR0247-01

FITA CETIM ESTAMPADA
APROX. 4CM*10M

CÓDIGO DE BARRA: 7899724628026
NCM: 5407.51.00 IPI: 0% (NACIONAL)

FRAÇÃO **UNIDADE**

ESGOTADO

PREÇO POR ROLO



REF.:LB0041-P2

FITA GORGURÃO BOLINHAS 2
APROX. 2,5CM*9,8M

CÓDIGO DE BARRA: 7908221607660
NCM: 5806.32.00 IPI: 0%

FRAÇÃO **UNIDADE**

R\$ 7,50

PREÇO ROLO

AMARRADOR DE CABELO



REF.: AC0012-1

ACESSÓRIO PARA CABELO TIPO AMARRADOR MOD. 1 - 1 kg

CÓDIGO DE BARRA: 7908221666674

NCM: 9615.19.00 IPI: 9,75%

FRAÇÃO PACOTE

R\$ 49,75

PREÇO PACOTE



REF.: AC0012-12

ACESSÓRIO PARA CABELO
AMARRADOR MOD. 1 - 1 kg

CÓDIGO DE BARRA: 7908221666681

NCM: 9615.19.00 IPI: 9,75%



REF.: AC0012-8

ACESSÓRIO PARA CABELO
AMARRADOR MOD. 1 - 1 kg

CÓDIGO DE BARRA: 7908221666698

NCM: 9615.19.00 IPI: 9,75%



REF.: AC0012-14

ACESSÓRIO PARA CABELO
AMARRADOR MOD. 1 - 1 kg

CÓDIGO DE BARRA: 7908221666704

NCM: 9615.19.00 IPI: 9,75%



REF.: AC0012-19

ACESSÓRIO PARA CABELO
AMARRADOR MOD. 1 - 1 kg

CÓDIGO DE BARRA: 7908221666773

NCM: 9615.19.00 IPI: 9,75%



REF.: AC0012-5

ACESSÓRIO PARA CABELO
AMARRADOR MOD. 1 - 1 kg

CÓDIGO DE BARRA: 7908221666711

NCM: 9615.19.00 IPI: 9,75%



REF.: AC0012-4

ACESSÓRIO PARA CABELO
AMARRADOR MOD. 1 - 1 kg

CÓDIGO DE BARRA: 7908221666728

NCM: 9615.19.00 IPI: 9,75%



REF.: AC0012-9

ACESSÓRIO PARA CABELO
AMARRADOR MOD. 1 - 1 kg

CÓDIGO DE BARRA: 7908221666735

NCM: 9615.19.00 IPI: 9,75%



REF.: AC0012-20

ACESSÓRIO PARA CABELO
AMARRADOR MOD. 1 - 1 kg

CÓDIGO DE BARRA: 7908221666780

NCM: 9615.19.00 IPI: 9,75%



REF.: AC0012-15

ACESSÓRIO PARA CABELO
AMARRADOR MOD. 1 - 1 kg

CÓDIGO DE BARRA: 7908221666742

NCM: 9615.19.00 IPI: 9,75%



REF.: AC0012-7

ACESSÓRIO PARA CABELO
AMARRADOR MOD. 1 - 1 kg

CÓDIGO DE BARRA: 7908221666759

NCM: 9615.19.00 IPI: 9,75%



REF.: AC0012-18

ACESSÓRIO PARA CABELO
AMARRADOR MOD. 1 - 1 kg

CÓDIGO DE BARRA: 7908221666766

NCM: 9615.19.00 IPI: 9,75%



REF.: AC0012-21

ACESSÓRIO PARA CABELO
AMARRADOR MOD. 1 - 1 kg

CÓDIGO DE BARRA: 7908221666797

NCM: 9615.19.00 IPI: 9,75%



REF.: AC0012-22

ACESSÓRIO PARA CABELO
AMARRADOR MOD. 1 - 1 kg

CÓDIGO DE BARRA: 7908221666803

NCM: 9615.19.00 IPI: 9,75%



REF.: AC0012-13

ACESSÓRIO PARA CABELO
AMARRADOR MOD. 1 - 1 kg

CÓDIGO DE BARRA: 7908221666841

NCM: 9615.19.00 IPI: 9,75%



REF.: AC0012-23

ACESSÓRIO PARA CABELO
AMARRADOR MOD. 1 - 1 kg

CÓDIGO DE BARRA: 7908221666810

NCM: 9615.19.00 IPI: 9,75%



REF.: AC0012-25

ACESSÓRIO PARA CABELO
AMARRADOR MOD. 1 - 1 kg

CÓDIGO DE BARRA: 7908221666834

NCM: 9615.19.00 IPI: 9,75%



AMARRADOR DE CABELO

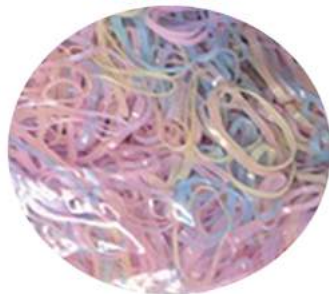

REF.: AC0012-24

ACESSÓRIO PARA CABELO TIPO AMARRADOR
MOD. 24 - 1 kg

CÓDIGO DE BARRA: 7908221666827

NCM: 9615.19.00 IPI: 9,75%

FRAÇÃO SACOLA

R\$ 49,75

PREÇO SACOLA